

CATALOGUE 2018

Get organised™



WELCOME TO TENG TOOLS

Here we present the product range that has made Teng Tools the respected brand it is today, together with a number of new products that still make Teng Tools the natural choice for professional users.

With the help of our range, which includes close to 3,000 products covering tools and storage solutions, we help companies to streamline their operations. Good tools are an important part and the organisation of them is just as important.

Our customers

The wide Teng Tools range caters to mechanics and craftsmen within industry, workshops, the automotive and construction sectors.

Our customers are found in all fields from large industrial companies and vehicle manufacturers to the major names within racing as well as your neighbour in his garage. Our global distribution network can manage large and small orders with quick service, competitive prices and optimal quality.

Development

We continuously develop our range in close co-operation with professional users. Teng Tools offers innovative Swedish design and sound Taiwanese production, which satisfies quality-conscious users around the world.



MISSION

*At Teng Tools we believe in order and clarity.
That is professionalism at work or pure enjoyment after work.
Some think perfect organisation is tedious. We consider it to be
one of man's most basic needs.
Join us – Get organised!*

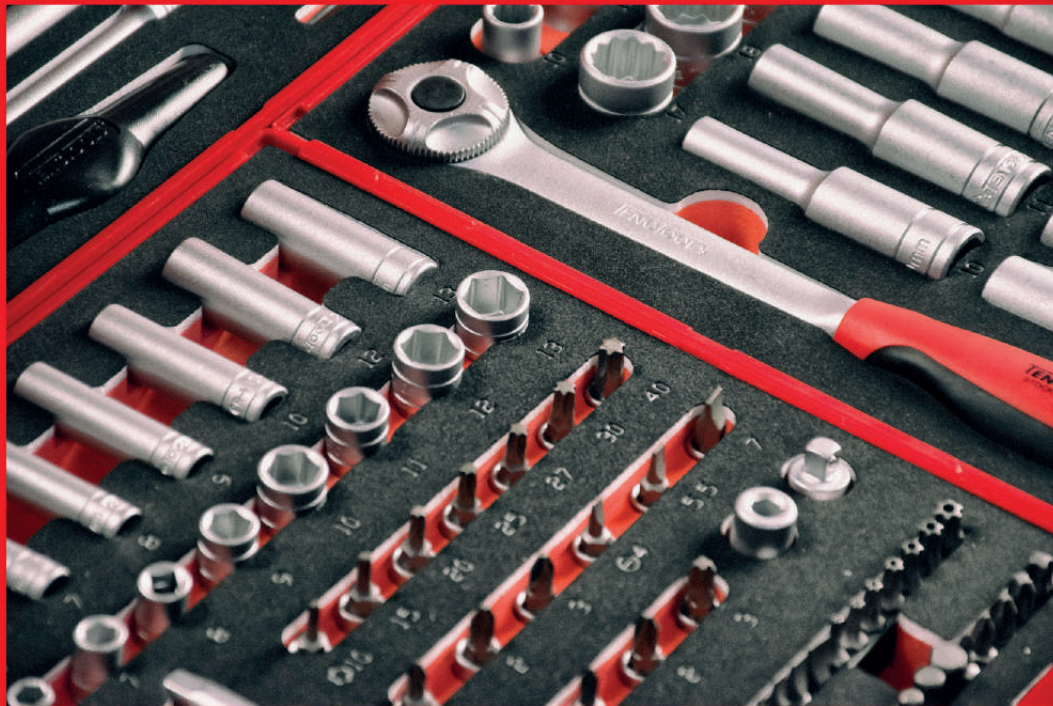

EVERLASTING POWER GUARANTEE



Teng Tools products meet – or surpass – the requirements in ISO, DIN and other international standards. As extra security, our “Everlasting power guarantee” means that all Teng Tools products will be replaced or repaired should they break during normal usage due to a manufacturing or material fault.

INDEX



**Tool kits
and tool storage**
Pages 6 to 129



**Work benches
and wall racks**
Pages 130 to 149



Socket Sets
Pages 150 to 179



**Sockets
and accessories**
Pages 180 to 204



Stainless steel socketry
Pages 204 to 207



Impact sockets
Pages 208 to 227



**Spanners
and wrenches**
Pages 228 to 277



Torque equipment
Pages 278 to 293



Screwdrivers and bits
Pages 294 to 327



Insulated tools
Pages 328 to 335



**Pliers
and clamping tools**
Pages 336 to 357



Cutting tools
Pages 358 to 375



**Service tools
and eye protection**
Pages 376 to 417



Air tools
Pages 418 to 426



Measuring Tools
Pages 427 to 430



Teng Collection
Pages 431 to 440



WORKING WITH WINNERS

A SELECTION OF THE MANY CHAMPIONS AT WORLD, EUROPEAN AND NATIONAL LEVEL THAT CHOOSE TENG TOOLS



JASON DOYLE



WORLD SPEEDWAY CHAMPIONSHIP 2017



WINNER

With no brakes and no gears speedway racing is one of the most extreme motor sports. A punctured lung, dislocated shoulder and shattered elbow in 2016 could not hold Doyle back for long. Teng Tools has been the preferred choice of almost every world champion since the 1990's and 2017 was no exception with Doyle making a dramatic comeback from injury to take the title. The Australian rider has been a long time user of Teng Tools both for his GP team and also for his league racing in the UK, Sweden and Poland.



FREDDIE LINDGREN



PREMIERSHIP RIDERS CHAMPIONSHIP 2017

WINNER

In September 2017 "Fast" Freddie Lindgren won the British Speedway Premiership Riders Championship title for a second successive year and was lying in third place in the world championship with just two rounds to go. A nasty crash in Manchester saw him side lined for the remainder of the 2017 season and in a neck brace but the long-time user of Teng Tools will be back next year determined to add more titles to an impressive list of championships won.



JOHAN KRISTOFFERSSON



FIA WORLD RALLYCROSS CHAMPIONSHIP 2017



WINNER



FIA WORLD RALLYCROSS TEAM CHAMPIONSHIP 2017



WINNER

At the beginning of the year Swedish born Johan Kristoffersson joined forces with long standing Teng Tools partner, Petter Solberg, to compete in the 2017 FIA World Rally Cross Championship. Not only did Johan win the drivers' championship but together with Petter they dominated almost every one of the 12 WRX rounds around the world to take the team championship as well. An incredible achievement in the brand new, unproven VW Polo Supercars.



TOM INGRAM



BTCC INDEPENDENT DRIVERS' CHAMPIONSHIP 2017



WINNER

Teng Tools has been helping Tom Ingram in his racing career for many years now helping him to win junior karting championship titles through to his many wins and British championship titles in Ginetta racing, always with the famous Teng eyes on his race car. 2017 was Tom's best year to date winning the independent drivers and team titles in the prestigious British Touring Car Championship and beating many top names and factory supported teams to finish third overall in the drivers' championship.

Get organised™

GET ORGANISED: IN THE WORKSHOP

The system for the workshop that results in improved profitability

Well organised and efficient work creates profitability. Using our solution you always know where you have your tools. This saves time and your production becomes more cost effective.

Our system for order divides your workplace into three zones: **READY, STEADY, GO!**

Several employees use the same cabinet, and tools are kept in different places.

Without a good system tools disappear and unnecessary time is spent looking for them.

Rarely used tools take up work space when a good storage system is not used.

CHALLENGES IN THE WORKSHOP

Tools have to be collected in bundles when a good mobile solution is not used.

The tools become spread out when there is no natural gathering point close to the work area.

IMPROVEMENTS

INCREASED EFFICIENCY

COST-EFFECTIVE WORK

MORE TASKS PERFORMED EVERYDAY

READY

In the Ready zone are the tools you need to have, but rarely use. Maybe once a week, once a month or a few times a year. When you need them you move them over to the Steady zone.



STEADY

The Steady zone holds the tools you use every day. These are stored on a tool panel or in a cabinet. This must be close to your Go zone so that you can quickly and easily collect and put back your tools.



GO!

You do the work in the Go zone. With the right space and equipment you can do a good job. Remember to have your tools in order when moving between jobs, as missing tools delay the work.



WORK FLOW:

1.

Analyse your workflow

2.

Sort through

3.

Plan your zones

4.

Update your workplace

More details about our system for order can be found in the brochure: **READY, STEADY, GO!** or at www.tengtools.com

TOOL STORAGE

The Teng Tools range of tool boxes and roller cabinets has been developed to meet the high demands made by quality conscious professional users from all over the world.

No details have been left to chance during the production of our high quality tool boxes and roller cabinets. The range comprises 8 top boxes, 2 middle boxes, 11 roller cabinets and 5 side cabinets and a collection of accessories.

Side tables, side drawers and tool panels can be placed on both sides of all Teng Tools roller cabinets with a width of 670 mm. If the roller cabinet is equipped with a tool panel at the top, a side panel needs to be fitted before the cabinet or drawer module are fitted.



Shelf with magnetic attachment for aerosols 580CM



Shelf with magnetic attachment 580M



Plastic bowl with magnetic base 580Q



Plastic bowl with magnetic base 580R

If the roller cabinet is equipped with a tool panel, the side panel TCW-SP01 needs to be fitted before the cabinet or drawer module are fitted.



TCW-CAB02



TCW-CAB03



TCW-D3



TCW-CAB01



TCW-CAB02



TCW-GAB03



TCW-CAB04



TCW-D3



TCW-SP01



50% MORE SPACE

THAN A STANDARD ROLLER CABINET

953mm

REMOVABLE WORKTOP
MADE FROM LAMINATED
CHIPBOARD WITH
REINFORCED EDGING

COMBINATION LOCK

ONE DRAWER OPENING
FUNCTION TO PREVENT
FALLING OVER

LARGER SLIDES FOR MORE
STABLE DRAWERS

ONE EMPTY DRAWER
FOR EXTRA STORAGE
OF LARGE ITEMS

TWO FIXED AND TWO SWIVEL
5" CASTORS WITH BRAKES



**622 PIECE TOOLKIT SUPPLIED IN THE
NEW 37" WIDE ROLLER CABINET AND
WOODEN WORKTOP TO CREATE THE
ULTIMATE WORKSTATION**

Stock No. **TCMM622N**



TOOL SETS

Organise your workshop with the help of Teng Tools!

Teng Tools is comparatively unique as we offer a complete system, which allows you to create your own tool sets in a structured and organised fashion.

Choose from different tool boxes and roller cabinets as well as more than 160 different TT trays and create your own tool sets with the help of our web-based application Click and Fill.

However, Teng Tools has put together a number of turnkey tool sets to make the selection process easier. The various proposals – which comprise everything from small portable tool sets to the huge Monster Mega Master with its 1,190 pieces – have been developed in collaboration with professional users from the automotive sector and other industries.



- Choose from our turnkey tool sets – there are 19 different sets in all sizes – or create your own personal tool set.
- There are more than 85 different TT trays, 13 different TTD sets, more than 25 extra-long TTX sets, 6 PS sets, 20 EVA sets in foam and 25 of the new TED sets with EVA-foam inserts to choose from. This gives you the opportunity to design a personal, yet very well organised and space efficient tool set.
- Choose between 22 different tool boxes and roller cabinets as well as service cases.
- Freely combine TT trays and tool boxes – there is virtually an unlimited number of tool set possibilities for any application.

Drawer No	Stock no	Description
1/10	TTD914N	14 piece screwdriver set
1/10	TTMD74	74 piece ratcheting bits driver set
1/10	TTMD12D	12 piece screwdriver set
1/10	TTX918N	8 piece screwdriver set
2/10	TTD912TXN	12 piece TX driver set
2/10	TTMH16	16 piece mini tool set
2/10	TT01	Add on tool tray
2/10	TTXMDTN	5 piece power thru screwdriver set
3/10	TT1435	35 piece 1/4" drive socket set
3/10	TT3819	19 piece 3/8" drive socket set
3/10	TT1205	5 piece 1/2" drive socket accessory set
3/10	TT1217	17 piece 1/2" drive socket set
3/10	TTXEXT13	13 piece extension bar set
4/10	TTAF32	32 piece 1/4" and 3/8" drive AF socket set
4/10	TT1215AF	15 piece 1/2" drive AF socket set
4/10	TT1211	11 piece 1/2" drive deep socket set
4/10	TT3816	16 piece 3/8" drive deep socket set
4/10	TTX00	Add on tool tray
5/10	TTHEX7	7 piece T handle hex driver set
5/10	TTHEX7AF	7 piece T handle AF hex driver set
5/10	TTHT28	28 piece hex and TX key set
5/10	TTTX7	7 piece T handle TX key set
5/10	TTX03	Add on tool tray
6/10	TTD441-T	8 piece plier set
6/10	TT474-7	4 piece 7" circlip plier set
6/10	TT00	Add on tool tray
6/10	TTX474-9	4 piece 9" circlip plier set
7/10	TTM03	3 piece inspection tool set
7/10	TTCM05D	5 piece measuring tool set
7/10	TTSR04	4 piece scraper and removal tool set
7/10	TTNF12	12 piece needle file set
7/10	TTXF05	5 piece file set
8/10	TTDCT05	5 piece cutting tool set
8/10	TTK40	40 piece knife set
8/10	TTPC09	9 piece punch and chisel set
8/10	TTX03	Add on tool tray
9/10	TT1236	12 piece combination spanner set
9/10	TT6508R	8 piece ratcheting combination spanner set
9/10	TT6208	8 piece double open ended spanner set
9/10	TT6010M	10 midjet combination spanners
9/10	TTX2032	7 piece combination spanner set
10/10	TTX2640	7 piece combination spanner set
10/10	TT3592	8 piece AF combination spanner set
10/10	TTR0RS	6 piece RORS wrench set
10/10	TT6506	6 piece double flex wrench set
10/10	TTBS35	35 piece bits set
1/9	TT9015HX	15 piece impact hex bit socket set
1/9	TT9212TX	12 piece impact TX bit set
1/9	TT9207	7 piece impact accessory set
1/9	TT9116	16 piece 1/2" drive impact socket set
1/9	TTX3404	4 piece 3/4" drive socket accessory set
1/9	TTD9416	16 piece 3/4" drive impact socket set
1/9	TTX3414	14 piece 3/4" drive socket set
1/9	TTDAW12C	1/2" drive composite air gun
2/9	TTV440	4 piece insulated plier set
2/9	TTD910N	10 piece insulated screwdriver set
2/9	TTHEX23	23 piece 1/2" drive hex bit socket set
2/9	TTXMDN	9 piece nut driver set
3/9	TTVG05	5 piece power grip plier set
3/9	TTADJ04	4 piece adjustable wrench set
3/9	TTCP121	121 piece crimping plier set
3/9	TTCP04	4 piece ratchet crimping plier set
3/9	TTX6311	11 piece double ring spanner set
4/9	TTSP09	9 piece general tool kit
4/9	TTX1292	1/2" drive angular gauge torque wrench
5/9	TTSPSG	4 Power grip pliers
5/9	TTX3892	3/8" drive torque wrench set

TCMONSTER Mega Master Tool Kit

The Monster Mega Master tool kit really is the ultimate tool kit. A 53" wide 10 drawer top box (TC810N) sits on top of a 9 drawer full width roller cabinet (TCW809N) both with all the Typically Teng features that you would expect from Teng Tools such as ball bearings, combination locks, etc. Inside you have over 80 individual tool trays containing over 1,100 individual pieces. It really is a set that covers just about every type of mechanics hand tool in one complete kit.



TCMONSTER Continued on next page →

Drawer No	Stock no	Description
6/9	TTDTD34	34 piece tap and die rethreading set
6/9	TTD01	Add on tool tray
6/9	TTX01	Add on tool tray
7/9	TTNR81	Nut sert gun set
7/9	TTHR81	Rivet gun set
7/9	TTID20	20 piece impact driver set
7/9	TTHP08	8 piece hook and pin wrench set
7/9	TTXPB3	3 piece roll/heel bar set
9/9	TTOS16	16 piece oil service kit
9/9	TTSN11	11 piece extractor set
9/9	TT804	4 piece puller set
9/9	TTHC03	3 piece hose clamp set
9/9	TTXPB3A	3 piece pry bar set

TCMONSTER Mega Master Tool Kit Continued

The Monster Mega Master tool kit really is the ultimate tool kit. A 53" wide 10 drawer top box (TC810N) sits on top of a 9 drawer full width roller cabinet (TCW809N) both with all the Typically Teng features that you would expect from Teng Tools such as ball bearings, combination locks, etc. Inside you have 80 individual tool trays containing over 1,100 individual pieces. It really is a set that covers just about every type of mechanics hand tool in one complete kit.

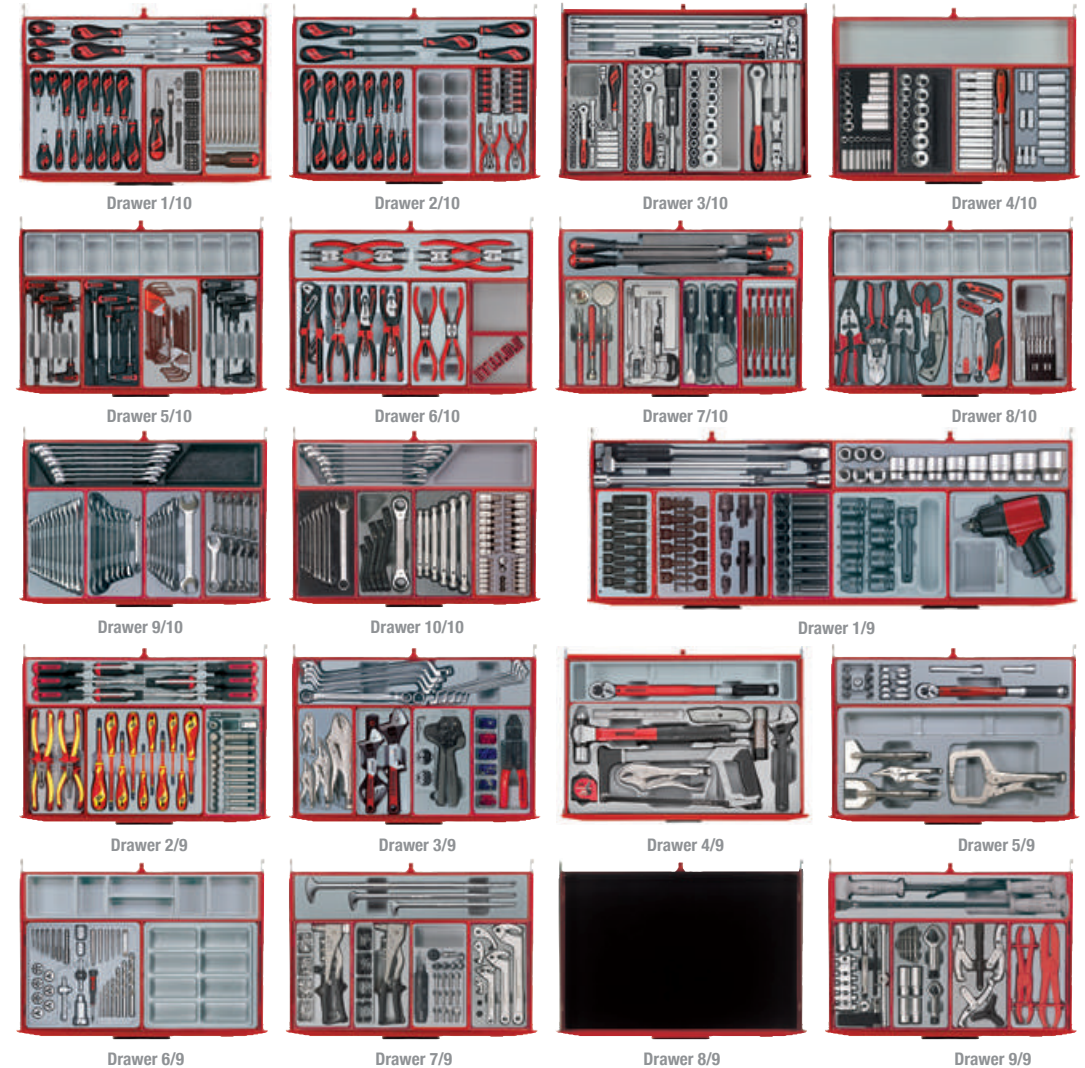

TCMONSTER Mega Master Tool kit
The Ultimate Monster Tool Kit

British GT championship winning Aston Martin GT3 car at Beechdean Motorsport Princess Risborough with the Teng Tools TCMonster tool kit

Drawer No	Stock no	Description
1/10	TTD914N	14 piece screwdriver set
1/10	TTMD74	74 piece ratcheting bits driver set
1/10	TTMD12D	12 piece screwdriver set
1/10	TTX918N	8 piece screwdriver set
2/10	TTD912TXN	12 piece TX driver set
2/10	TTM116	16 piece mini tool set
2/10	TT01	Add on tool tray
2/10	TTXMDTN	5 piece power thru screwdriver set
3/10	TT1435	35 piece 1/4" drive socket set
3/10	TT3819	19 piece 3/8" drive socket set
3/10	TT1205	5 piece 1/2" drive socket accessory set
3/10	TT1217	17 piece 1/2" drive socket set
3/10	TTXEXT13	13 piece extension bar set
4/10	TTAF32	32 piece 1/4" and 3/8" drive AF socket set
4/10	TT1215AF	15 piece 1/2" drive AF socket set
4/10	TT1211	11 piece 1/2" drive deep socket set
4/10	TT3816	16 piece 3/8" drive deep socket set
4/10	TTX00	Add on tool tray
5/10	TTHEX7	7 piece T handle hex driver set
5/10	TTHEX7AF	7 piece T handle AF hex driver set
5/10	TTHT28	28 piece hex and TX key set
5/10	TTTX7	7 piece T handle TX key set
5/10	TTX03	Add on tool tray
6/10	TTD441-T	8 piece plier set
6/10	TT474-7	4 piece 7" circlip plier set
6/10	TT00	Add on tool tray
6/10	TTX474-9	4 piece 9" circlip plier set
7/10	TTM03	3 piece inspection tool set
7/10	TTCM05D	5 piece measuring tool set
7/10	TTSR04	4 piece scraper and removal tool set
7/10	TTNF12	12 piece needle file set
7/10	TTXF05	5 piece file set
8/10	TTDCT05	5 piece cutting tool set
8/10	TTK40	40 piece knife set
8/10	TTPC09	9 piece punch and chisel set
8/10	TTX03	Add on tool tray
9/10	TTX2640	7 piece combination spanner set
9/10	TT3592	8 piece AF combination spanner set
9/10	TTRORS	6 piece RORS wrench set
9/10	TT6506	6 piece double flex wrench set
9/10	TTBS35	35 piece bits set
10/10	TT1236	12 piece combination spanner set
10/10	TT6508R	8 piece ratcheting combination spanner set
10/10	TT6208	8 piece double open ended spanner set
10/10	TT6010M	10 midget combination spanners
10/10	TTX2032	7 piece combination spanner set
1/9	TTBE18	18 piece stud extractor set
1/9	TT9015HX	15 piece impact hex bit socket set
1/9	TT9024	24 piece 1/4" and 3/8" drive impact socket set
1/9	TT9212TX	12 piece impact TX bit set
1/9	TT9207	7 piece impact accessory set
1/9	TT9116	16 piece 1/2" drive impact socket set
1/9	TTX3404	4 piece 3/4" drive socket accessory set
1/9	TTD9416	16 piece 3/4" drive impact socket set
1/9	TTX3414	14 piece 3/4" drive socket set
2/9	TTV440	4 piece insulated plier set
2/9	TTD910N	10 piece insulated screwdriver set
2/9	TTHEX23	23 piece 1/2" drive hex bit socket set
2/9	TTXMDN	9 piece nut driver set
3/9	TTVG05	5 piece power grip plier set
3/9	TTADJ04	4 piece adjustable wrench set
3/9	TTCP121	121 piece crimping plier set
3/9	TTCP04	4 piece ratchet crimping plier set
3/9	TTX6311	11 piece double ring spanner set
4/9	TTPS09	9 piece general tool kit
4/9	TTX1292	1/2" drive angular gauge torque wrench

TCMONSTER02 Mega Master Tool Kit NEW!

The Monster Mega Master tool kit really is the ultimate tool kit. A 53" wide 10 drawer top box (TC810N) sits on top of a 9 drawer full width roller cabinet (TCW809N) both with all the Typically Teng features that you would expect from Teng Tools such as ball bearings, combination locks, etc. Inside you have over 80 individual tool trays containing over 1,100 individual pieces. It really is a set that covers just about every type of mechanics hand tool in one complete kit. (overall weight 365 kilos).



Drawer No	Stock no	Description
5/9	TTSPSG	4 Power grip pliers
5/9	TTX3892	3/8" drive torque wrench set
6/9	TTD034	34 piece tap and die rethreading set
6/9	TTX01	Add on tool tray
6/9	TTD01	Add on tool tray
7/9	TTNR81	Nut sert gun set
7/9	TTHR81	Rivet gun set
7/9	TTID20	20 piece impact driver set
7/9	TTHP08	8 piece hook and pin wrench set
7/9	TTXPB3	3 piece roll/heel bar set
9/9	TTOS16	16 piece oil service kit
9/9	TTSN11	11 piece extractor set
9/9	TT804	4 piece puller set
9/9	TTHC03	3 piece hose clamp set
9/9	TTXPB3A	3 piece pry bar set

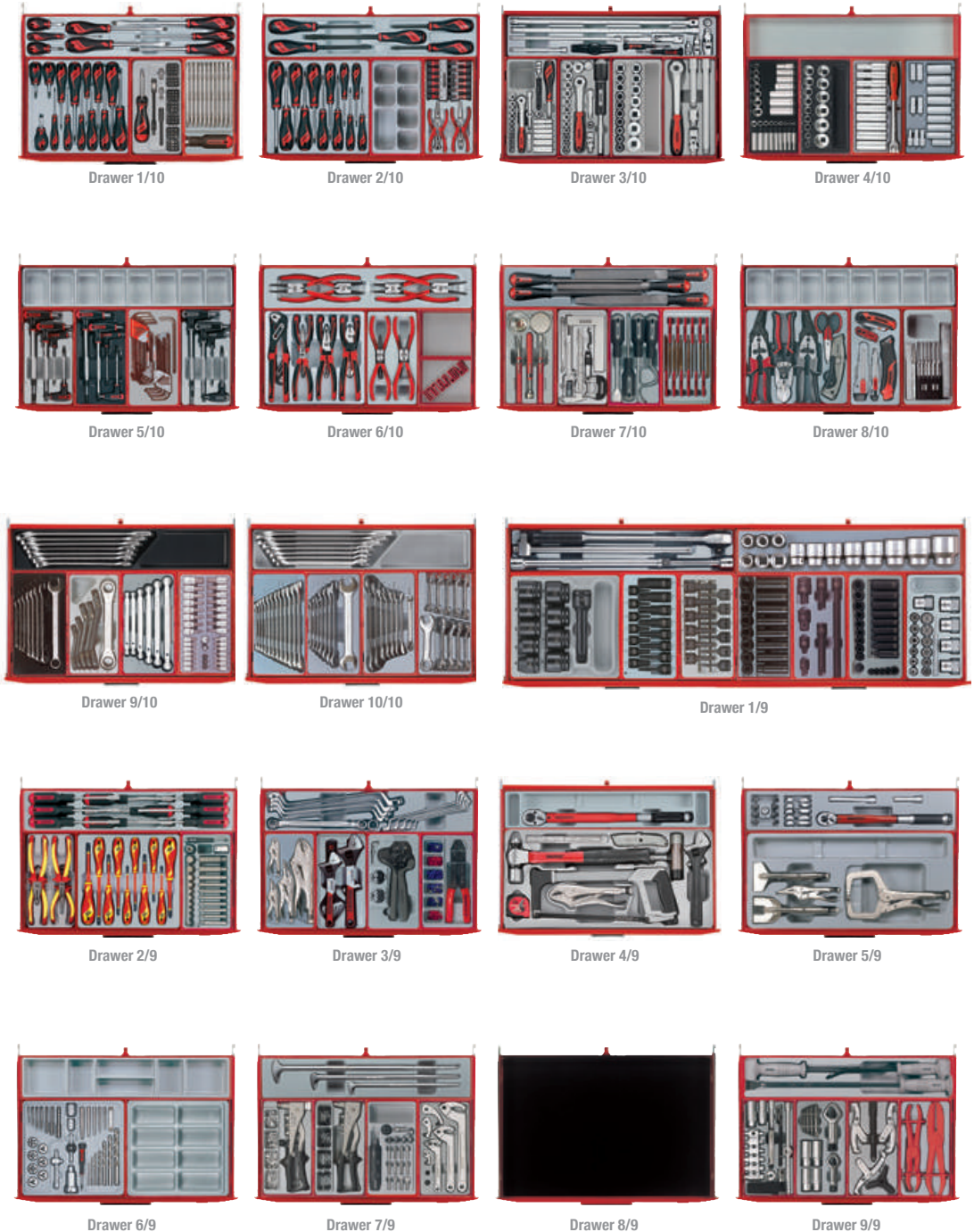

TCMONSTER02 Mega Master Tool Kit NEW!

TCMM1055N 1055 Piece Tool Kit

A comprehensive 1,055 piece tool kit covering just about every type of regularly used technician's tools. Built up using the unique Teng Tools TC tray system and supplied in a TC806NF/TC803N/TCW807N 8 series ball bearing top box/middle box/roller cabinet combination. TCF01 brackets are included for securing the middle box to the roller cabinet. The TCW-SP01 side plate is also included for hanging additional tools on the outside using Teng Tools hooks (see tool storage accessories). (overall weight 183.6 kilos).

Drawer No	Stock no	Description
2/6	1476NTX1	8 piece fold up ball point TX key set
2/6	1477NX	8 piece fold up screwdriver key set
2/6	587H	Magnifying glass with LED light
4/6	TT1435	35 piece 1/4" drive regular/deep metric socket set
4/6	TT3819	19 piece 3/8" drive metric socket set
4/6	TT1218	18 piece 1/2" drive metric socket set
4/6	TT1211	11 piece 1/2" drive deep metric socket set
5/6	TT1236	12 piece metric combination spanner set
5/6	TT6010M	10 piece midget combination spanner set
5/6	TT6508RS	8 piece metric ratchet combination spanner set
5/6	TTADJ04	4 piece adjustable wrench set
6/6	TTHEX7	7 piece metric T handle hex key set
6/6	TTTX7	7 piece T handle TX driver set
6/6	TTHT28	28 piece hex and TX key set
6/6	TT804	4 piece puller set
1/3	TTD441-T	8 piece plier set
1/3	TT474-7	4 piece 7" circlip plier set
1/3	TTM16	16 piece mini plier and screwdriver set
2/3	TTCP04	4 piece ratcheting crimping plier set
2/3	TTCP121	121 piece crimping tool set
2/3	TTV440	4 piece 1000 volt insulated plier set
2/3	TTV907N	7 piece 1000 volt insulated screwdriver set
3/3	TTTF10	10 piece flaring tool set
3/3	TTK40	40 piece knife set
3/3	TTDCT05	5 piece cutting tool set
1/7	TTD914N	14 piece screwdriver set
1/7	TT917TXN	7 piece TX driver set
1/7	TTMD74	74 piece ratcheting bits driver set
1/7	TTX918N	8 piece screwdriver set
2/7	TTHR81	Rivet gun set
2/7	TTNR81	Nutsert gun set
2/7	TTSD39	39 piece torque screwdriver set
2/7	TTBE18	18 piece stud extractor set
2/7	TTX1292	1/2" drive torque wrench
3/7	TTVG05	5 piece power grip plier set
3/7	TTID20	20 piece impact driver set
3/7	TTPC09	9 piece punch and chisel set
3/7	TTNF12	12 needle file set
3/7	TTXEXT13	13 piece extension set
4/7	TTAF32	32 piece 1/4" and 3/8" drive AF socket set
4/7	TT1215AF	15 piece 1/2" drive AF socket set
4/7	TTCM05D	5 piece measuring tool set
4/7	TTTT08	8 piece inspection tool set
4/7	TTXTB09	9 piece 3/8" drive spark plug socket set
5/7	TTTXH15	15 piece 1/2" drive hex and TX socket set
5/7	TTX30	30 piece TX, TPX and TXE socket set
5/7	TTRS15	15 piece 1/2" drive Ribe socket set
5/7	TTBS35	35 piece 1/4" and 3/8" drive bit socket set
5/7	TTX2032	7 piece metric combination spanner set
6/7	TT9024	24 piece 1/4" and 3/8" drive metric impact socket set
6/7	TT9207	7 piece 3/8" and 1/2" drive impact socket accessory set
6/7	TT9116	16 piece 1/2" drive metric impact socket set
6/7	TTTS08	8 piece 1/2" drive wheel nut set
6/7	TTXPB3	3 piece roll/heel bar set
7/7	583M	Magnetic wrist band
7/7	TM149	4 in 1 hook and pick set
7/7	9850	6-24 volt circuit tester
7/7	DB034	34 piece fully ground drill bit set
	580	Magnetic bits tray

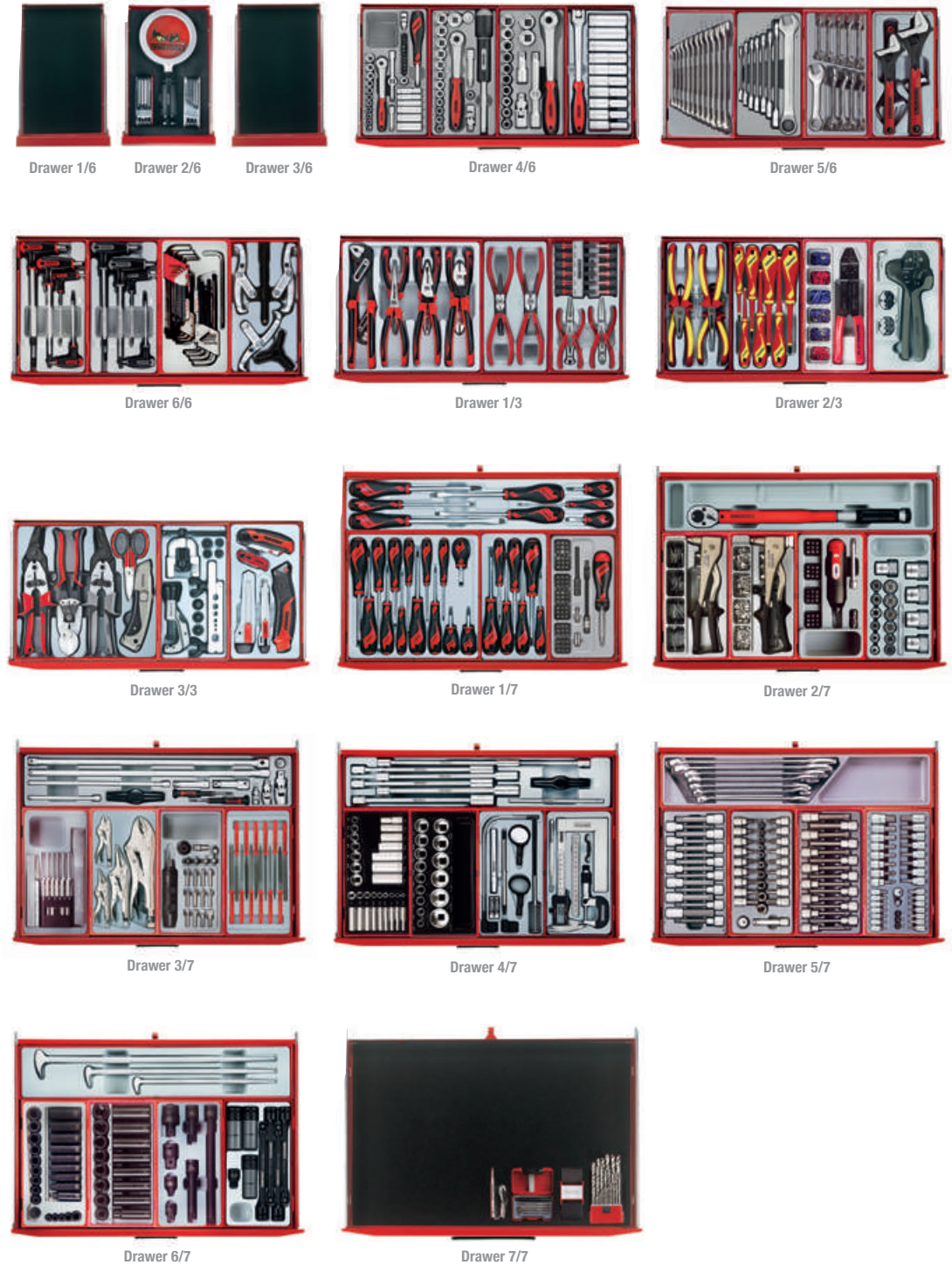

TCMM1055N 1055 Piece Tool Kit

TCMM1055EV 1055 Piece Tool Kit

A comprehensive 1,055 piece tool kit covering just about every type of regularly used technician's tools. Built up using the unique Teng Tools TC tray system and supplied in a TC806SV/TC803SV/TCW707EV 8 series ball bearing top box/middle box/roller cabinet combination. TCF01 brackets are included for securing the middle box to the roller cabinet. The TCW-SP01 side plate is also included for hanging additional tools on the outside using Teng Tools hooks (see tool storage accessories). (overall weight 183.6 kilos).

Drawer No	Stock no	Description
2/6	1476NTX1	8 piece fold up ball point TX key set
2/6	1477NX	8 piece fold up screwdriver key set
2/6	587H	Magnifying glass with LED light
4/6	TT1435	35 piece 1/4" drive regular/deep metric socket set
4/6	TT3819	19 piece 3/8" drive metric socket set
4/6	TT1218	18 piece 1/2" drive metric socket set
4/6	TT1211	11 piece 1/2" drive deep metric socket set
5/6	TT1236	12 piece metric combination spanner set
5/6	TT6010M	10 piece midget combination spanner set
5/6	TT6508RS	8 piece metric ratchet combination spanner set
5/6	TTADJ04	4 piece adjustable wrench set
6/6	TTHEX7	7 piece metric T handle hex key set
6/6	TTTX7	7 piece T handle TX driver set
6/6	TTHT28	28 piece hex and TX key set
6/6	TT804	4 piece puller set
1/3	TTD441-T	8 piece plier set
1/3	TT474-7	4 piece 7" circlip plier set
1/3	TTM16	16 piece mini plier and screwdriver set
2/3	TTCP04	4 piece ratcheting crimping plier set
2/3	TTCP121	121 piece crimping tool set
2/3	TTV440	4 piece 1000 volt insulated plier set
2/3	TTV907N	7 piece 1000 volt insulated screwdriver set
3/3	TTTF10	10 piece flaring tool set
3/3	TTK40	40 piece knife set
3/3	TTDCT05	5 piece cutting tool set
1/7	TTD914N	14 piece screwdriver set
1/7	TT917TXN	7 piece TX driver set
1/7	TTMD74	74 piece ratcheting bits driver set
1/7	TTX918N	8 piece screwdriver set
2/7	TTHR81	Rivet gun set
2/7	TTNR81	Nutsert gun set
2/7	TTSD39	39 piece torque screwdriver set
2/7	TTBE18	18 piece stud extractor set
2/7	TTX1292	1/2" drive torque wrench
3/7	TTVG05	5 piece power grip plier set
3/7	TTID20	20 piece impact driver set
3/7	TTPC09	9 piece punch and chisel set
3/7	TTNF12	12 needle file set
3/7	TTXEXT13	13 piece extension set
4/7	TTAF32	32 piece 1/4" and 3/8" drive AF socket set
4/7	TT1215AF	15 piece 1/2" drive AF socket set
4/7	TTCM05D	5 piece measuring tool set
4/7	TTTT08	8 piece inspection tool set
4/7	TTXTB09	9 piece 3/8" drive spark plug socket set
5/7	TTTXH15	15 piece 1/2" drive hex and TX socket set
5/7	TTX30	30 piece TX, TPX and TXE socket set
5/7	TTRS15	15 piece 1/2" drive Ribe socket set
5/7	TTBS35	35 piece 1/4" and 3/8" drive bit socket set
5/7	TTX2032	7 piece metric combination spanner set
6/7	TT9024	24 piece 1/4" and 3/8" drive metric impact socket set
6/7	TT9207	7 piece 3/8" and 1/2" drive impact socket accessory set
6/7	TT9116	16 piece 1/2" drive metric impact socket set
6/7	TTTS08	8 piece 1/2" drive wheel nut set
6/7	TTXPB3	3 piece roll/heel bar set
7/7	583M	Magnetic wrist band
7/7	TM149	4 in 1 hook and pick set
7/7	9850	6-24 volt circuit tester
7/7	DB034	34 piece fully ground drill bit set
	580	Magnetic bits tray

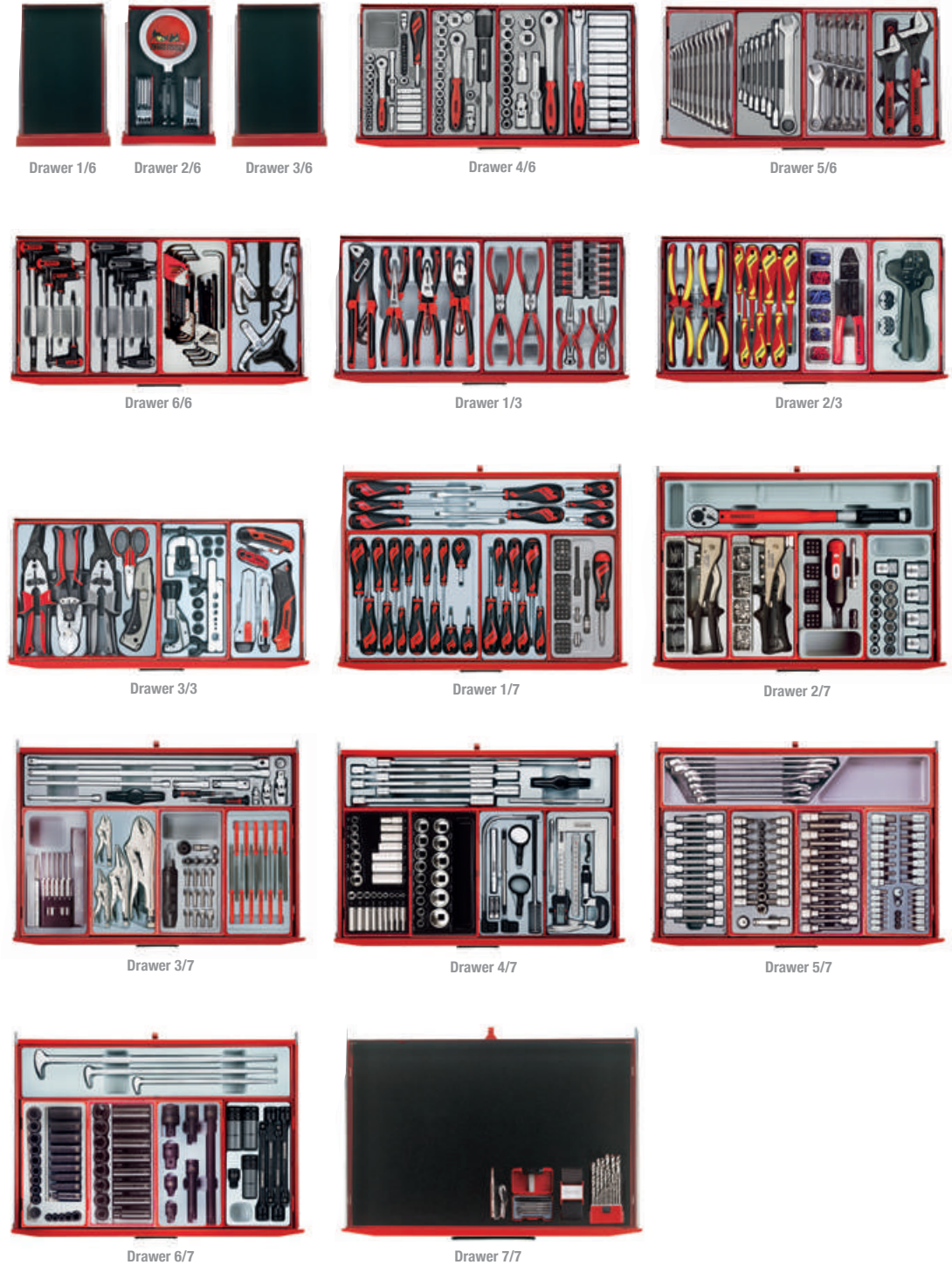

TCMM1055EV 1055 Piece Tool Kit

Teng Tools

Teng Tools

Drawer No	Stock no	Description
1/6	TM708	8 piece mini screwdriver set
1/6	1479MM	9 piece ball point hex key wrench set
1/6	1479AF	9 piece AF ball point hex key wrench set
1/6	1479TX	9 piece TX wrench set
4/6	TTHX7	7 piece T handle hex drivers
4/6	TNRR81	Nutsert rivet set
4/6	TTTX7	7 piece T handle TX/TPX drivers
4/6	TTHR81	Rivet gun set
5/6	TT1236	12 piece metric combination spanner set
5/6	TTALU	32 piece socket clip rail set
5/6	TTM03	3 piece inspection tool set
5/6	TT6208	8 piece open ended spanner set
6/6	TTPS09	9 piece general tool kit with PS tray
1/3	TTPC09	9 piece punch and chisel set
1/3	TTID20	20 piece 1/2" drive impact driver set
1/3	TTSR04	4 piece scraper and remover set
1/3	TT00	Add on tool tray
2/3	TTHP08	8 piece hook and pin wrench set
2/3	TT6506	6 piece double flex wrench set
2/3	TT6010M	10 piece midget combination spanner set
2/3	TT3592	8 piece AF combination spanner set
3/3	TTXPB3	3 piece roll/heel bar set
3/3	TTX6311	11 piece metric double ring spanner set
1/10	TTXEXT13	13 piece extension set
1/10	TT1205	5 piece 1/2" drive socket accessories
1/10	TT1435	35 piece 1/4" drive regular/deep metric socket set
1/10	TT3819	19 piece 3/8" drive metric socket set
1/10	TT1217	17 piece 1/2" drive regular metric socket set
2/10	TTX23	23 piece 40/70mm TX bit socket set
2/10	TTHX23	23 piece metric hex bit socket set
2/10	TTALU	32 piece socket clip rail set
2/10	TTXMDTN	5 piece power thru screwdriver set
2/10	TT9116	16 piece 1/2" drive regular/deep impact socket set
3/10	TTX918N	8 piece Mega Drive screwdriver set
3/10	TT917N	7 piece Mega Drive screwdriver set
3/10	TT917TXN	7 piece TX/TPX Mega Drive screwdriver set
3/10	TTMD74	74 piece ratcheting bits driver set
3/10	TTM116	16 piece mini plier/screwdriver set
4/10	TTX474-9	4 piece 9" circlip plier set
4/10	TT440-T	4 piece Mega Bite plier set
4/10	TT474-7	4 piece 7" circlip plier set
4/10	TT474-5	4 piece 5" circlip plier set
4/10	TTHC03	3 piece hose clamp set
5/10	TTX1292	1/2" drive torque wrench
5/10	TTV440	4 piece 1000v insulated plier set
5/10	TTCP121	121 piece crimping tool set
5/10	TTV907N	7 piece 1000v screwdriver set
5/10	TT01	Add on tool tray with dividers
6/10	TTX01	Add on tool tray with dividers
6/10	TT804	2 in 1 puller set
6/10	TTOS16	16 piece oil service set
6/10	TTSN11	11 piece stud and nut remover set
6/10	TTD17	17 piece tap and die set
7/10	TTX2032	7 piece metric combination spanner set
7/10	TTX3892	22 piece 3/8" drive torque wrench set
7/10	TTXPB3A	3 piece pry bar set
8/10	TTXMDN	9 piece nut driver set
8/10	TTPSPG	4 piece power grip pliers set
9/10	TTX2640	7 piece AF combination spanner set
9/10	TTTXH15	15 piece 1/2" drive long bits socket set
9/10	TT1215AF	15 piece 1/2" drive AF regular socket set
9/10	TTAF32	32 piece 1/4" and 3/8" drive regular/deep AF socket set
9/10	TTTX30	30 piece 1/4" and 3/8" drive TX, TPX and TX-E socket set
10/10	TTX3404	4 piece 3/4" drive socket accessories set
10/10	TTX3414	14 piece 3/4" drive metric socket set
-	ABS-TOP	ABS top for roller cabinet
-	580	Magnetic Bits tray



TCMM1001N 1001 Piece Tool Kit
 A 1001 piece tool kit, one of the most complete tool kits supplied in the Teng Tools range. Built up using the unique Teng Tools TT tray system and covering just about every tool most people ever need. Supplied in a TC806NF/TC803N/TCW810N 8 series ball bearing top box/middle box/roller cabinet combination. Pallet size when delivered 120x80x112cm, (overall weight 220 kilos)

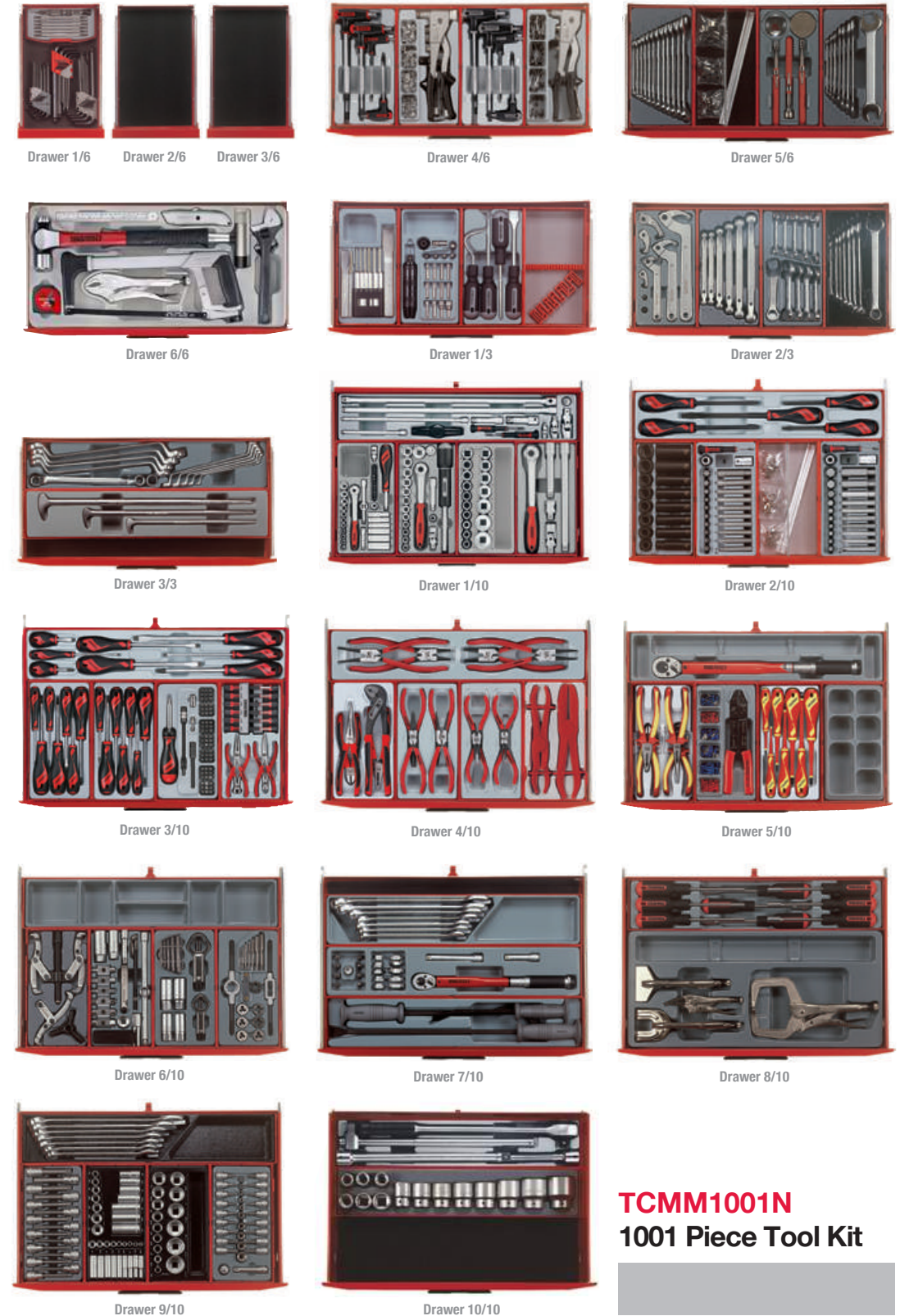

TCMM1001N
1001 Piece Tool Kit

Drawer No	Stock no	Description
1/6	TM708	8 piece mini screwdriver set
1/6	1479MM	9 piece ball point hex key wrench set
1/6	1479AF	9 piece AF ball point hex key wrench set
1/6	1479TX	9 piece TX wrench set
4/6	TTHEX7	7 piece T handle hex drivers
4/6	TTNR81	81 piece nut rivet set
4/6	TTTX7	7 piece T handle TX/TPX drivers
4/6	TTHR81	81 piece hand rivet set
5/6	TT1236	12 piece metric combination spanner set
5/6	TTALU	32 piece socket clip rail set
5/6	TTTM03	3 piece inspection tool set
5/6	TT6208	8 piece open ended spanner set
6/6	TTPS09	9 piece general tool kit with PS tray
1/3	TTPC09	9 piece punch and chisel set
1/3	TTID20	20 piece 1/2" drive impact driver set
1/3	TTSR04	4 piece scraper and remover set
1/3	TT00	Add on tool tray
2/3	TTHP08	8 piece hook and pin wrench set
2/3	TT6506	6 piece double flex wrench set
2/3	TT6010M	10 piece midget combination spanner set
2/3	TT3592	8 piece AF combination spanner set
3/3	TTXPB3	3 piece roll/heel bar set
3/3	TTX6311	11 piece metric double ring spanner set
1/10	TTXEXT13	13 piece extension set
1/10	TT1205	5 piece 1/2" drive socket accessories
1/10	TT1435	35 piece 1/4" drive regular/deep metric socket set
1/10	TT3819	19 piece 3/8" drive metric socket set
1/10	TT1217	17 piece 1/2" drive regular metric socket set
2/10	TTTX23	23 piece 40/70mm TX bit socket set
2/10	TTHEX23	23 piece metric hex bit socket set
2/10	TTALU	32 piece socket clip rail set
2/10	TTXMDTN	5 piece power thru screwdriver set
2/10	TT9116	16 piece 1/2" drive regular/deep impact socket set
3/10	TTX918N	8 piece Mega Drive screwdriver set
3/10	TT917N	7 piece Mega Drive screwdriver set
3/10	TT917TXN	7 piece TX/TPX Mega Drive screwdriver set
3/10	TTMD74	74 piece ratchetting bits driver set
3/10	TTM116	16 piece mini plier/screwdriver set
4/10	TTX474-9	4 piece 9" circlip plier set
4/10	TT440-T	4 piece Mega Bite plier set
4/10	TT474-7	4 piece 7" circlip plier set
4/10	TT474-5	4 piece 5" circlip plier set
4/10	TTHC03	3 piece hose clamp set
5/10	TTX1292	1/2" drive torque wrench
5/10	TTV440	4 piece 1000v insulated plier set
5/10	TTCP121	121 piece crimping tool set
5/10	TTV907N	7 piece 1000v screwdriver set
5/10	TT01	Add on tool tray with dividers
6/10	TTX01	Add on tool tray with dividers
6/10	TT804	2 in 1 puller set
6/10	TT0S16	16 piece oil service set
6/10	TTSN11	11 piece stud and nut remover set
6/10	TTTD17	17 piece tap and die set
7/10	TTX2032	7 piece metric combination spanner set
7/10	TTX3892	22 piece 3/8" drive torque wrench set
7/10	TTXPB3A	3 piece pry bar set
8/10	TTXMMDN	9 piece nut driver set
8/10	TTPSPG	4 piece power grip pliers set
9/10	TTX2640	7 piece AF combination spanner set
9/10	TTTXH15	15 piece 1/2" drive long bits socket set
9/10	TT1215AF	15 piece 1/2" drive AF regular socket set
9/10	TTAF32	32 piece 1/4" and 3/8" drive regular/deep AF socket set
9/10	TTTX30	30 piece 1/4" and 3/8" drive TX, TPX and TX-E socket set
10/10	TTX3404	4 piece 3/4" drive socket accessories set
10/10	TTX3414	14 piece 3/4" drive metric socket set
-	ABS-TOP	ABS top for roller cabinet
-	580	Magnetic Bits tray



TCMM1001P Personalised 1001 Piece Black Tool Kit

A 1001 piece tool kit, one of the most complete tool kits supplied in the Teng Tools range. Built up using the unique Teng Tools TT tray system and covering just about every tool most people ever need. Supplied in a TC819BK stack system of 8 series ball bearing top box/middle box/roller cabinet combination. All TCMM1001P kits are available with the option of having a personalised top box at no extra cost*. Pallet size when delivered 120x80x112cm, 220kilos nett.

Personalisation & Branding Service

Teng Tools have invested in their own Versacamm printing equipment enabling them to offer a complete personalisation and branding service for your tool box using vinyl cut transfers. Whether its a logo for your company or a picture of your favourite race team, this gives you the chance to have a toolbox that looks just the way you want it.



FREE*

Personalisation & Branding Service

It is now possible to personalise your tool box using vinyl cut stickers. This can be in the format of an image or logo, or may just be your name. This is now available to you through your local stockist. Logos to be supplied as high resolution eps, crr, or ai vector format with cutting path if required

*Subject to artwork being supplied in the correct format.



TCMM1001P Continued on next page →

TCMM1001P Personalised 1001 Piece Black Tool Kit Continued

A 1001 piece tool kit, one of the most complete tool kits supplied in the Teng Tools range. Built up using the unique Teng Tools TT tray system and covering just about every tool most people ever need. Supplied in a TC819BK stack system of 8 series ball bearing top box/middle box/roller cabinet combination. All TCMM1001P kits are available with the option of having a personalised top box at no extra cost*. Pallet size when delivered 120x80x112cm, 220kilos nett.



TCMM1001P 1001 Piece Tool Kit

Just about every tool most people ever need



TCMM715N 715 Piece Tool Kit

A 715 piece tool kit completely built up using the unique Teng Tools TC tray system and covering just about every tool most people will ever need. Supplied in a TC806NF/TC803N/TCW810N 8 series ball bearing slide top box/middle box/roller cabinet combination. Brackets TCF01 to connect the middle box to the roller cabinet are included. (overall weight 180 kilos)

Drawer No	Stock no	Description
4/6	TTM16	16 piece mini plier/screwdriver set
4/6	TTID20	20 piece 1/2" drive impact driver set
4/6	TTPC09	9 piece punch and chisel set
4/6	TT01	Add on tool tray with dividers
5/6	TT917N	7 piece Mega Drive screwdriver set
5/6	TT440-T	4 piece Mega Bite plier set
5/6	TT917TXN	7 piece TX/TPX Mega Drive screwdriver set
5/6	TTMD74	74 piece ratchetting bits driver set
6/6	TTPSPG	4 piece power grip pliers with PS tray
1/3	TT804	2 in 1 puller set
1/3	TTNR81	81 piece nut rivet set
1/3	TTTT17	17 piece tap and die set mm
1/3	TTHP08	8 piece hook and pin wrench set
2/3	TTHEX7	7 piece T handle hex drivers
2/3	TT474-7	4 piece 7" circlip plier set
2/3	TTX7	7 piece T handle TX/TPX drivers
2/3	TTHR81	Rivet gun set
3/3	TTX6311	11 piece mm double ring spanner set
3/3	TTXPB3	3 piece roll bar set
1/10	TTXEXT13	13 piece extension set
1/10	TT1435	35 piece 1/4" drive regular/deep metric socket set
1/10	TT3819	19 piece 3/8" drive metric socket set
1/10	TT1217	17 piece 1/2" drive regular metric socket set
1/10	TT1205	5 piece 1/2" drive socket accessories
2/10	TTX1292	1/2" drive torque wrench
2/10	TT9116	16 piece 1/2" drive regular/deep impact socket set
2/10	TTHEX23	23 piece metric hex bit socket set
2/10	TTALU	32 piece socket clip rail set
2/10	TTTX23	23 piece 40/70mm TX bit socket set
7/10	TTX2032	7 piece metric combination spanner set
7/10	TT1236	12 piece metric combination spanner set
7/10	TTSN11	11 piece stud and nut remover set
7/10	TTOS16	16 piece oil service set
7/10	TTALU	32 piece socket clip rail set
8/10	TTX918N	8 piece Mega Drive screwdriver set
8/10	TTPS09	9 piece general tool kit with PS tray
9/10	TTX2640	7 piece AF combination spanner set
9/10	TT3592	8 piece AF combination spanner set
9/10	TTAF32	32 piece 1/4" and 3/8" drive regular/deep AF socket set
9/10	TT1215AF	15 piece 1/2" drive AF regular socket set
9/10	TTTX30	30 piece 1/4" and 3/8" drive TX, TPX and TX-E socket set

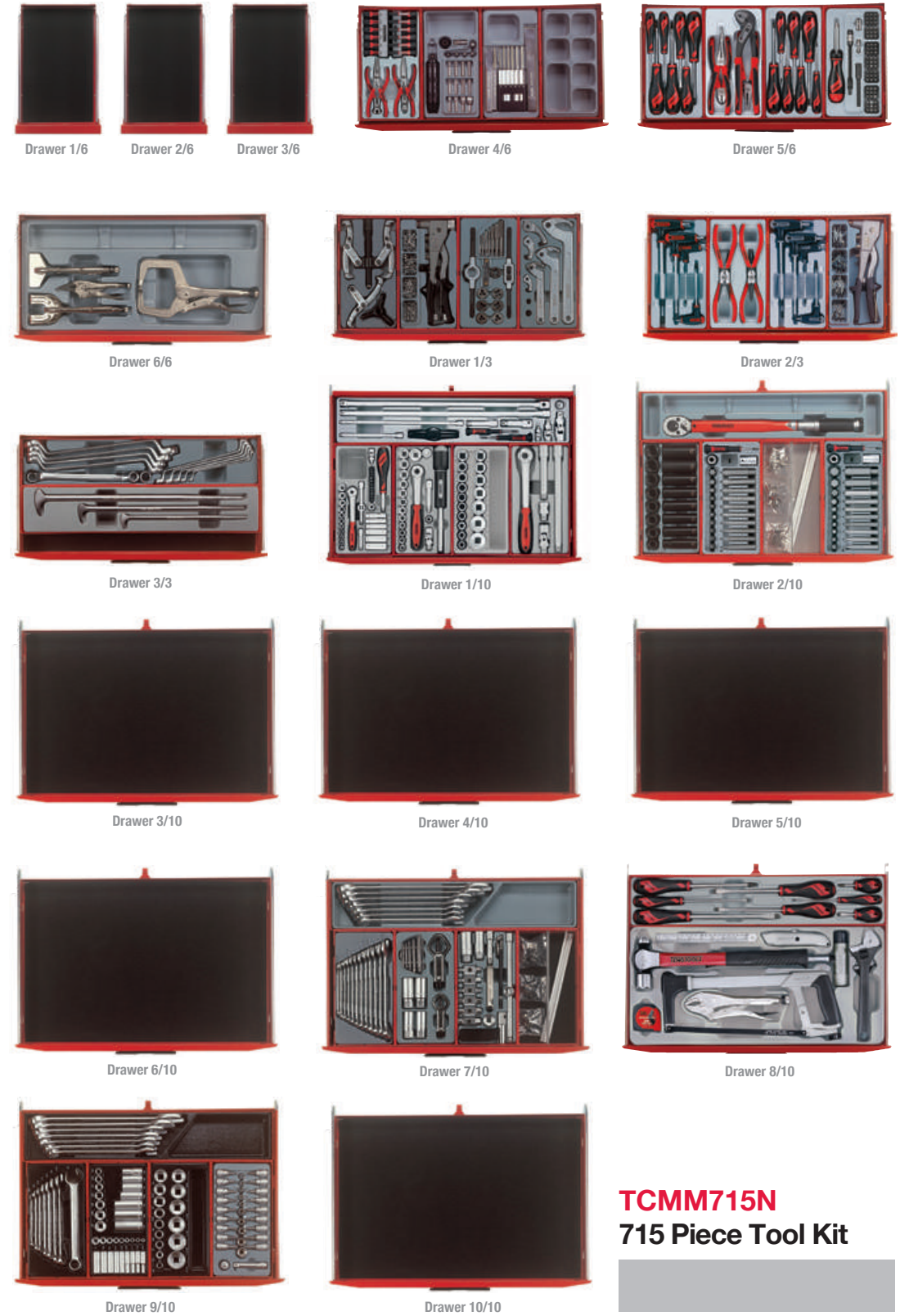

TCMM715N 715 Piece Tool Kit

TCMM715N 715 Piece Tool Kit

TCMM600 600 Piece Tool Kit

600 piece tool kit containing virtually every tool you will ever need. Supplied in the unique TC806NF/TC803N/TCW807N 8 series ball bearing slide top box/middle box/roller cabinet combination, together with the Teng Tools side plate. (overall weight 208 kilos)

Drawer No	Stock no	Description
4/6	TT1435	35 piece 1/4" drive regular/deep metric socket set
4/6	TT3819	19 piece 3/8" drive metric socket set
4/6	TT1217	17 piece 1/2" drive regular metric socket set
4/6	TT1205	5 piece 1/2" drive socket accessories
5/6	TT1236	12 piece metric combination spanner set
5/6	TT917N	7 piece Mega Drive screwdriver set
5/6	TT440	4 piece Mega Bite plier set
5/6	TTALU	32 piece socket clip rail set
6/6	TTPS09	Selection of general hand tools
1/3	TTXEXT13	13 piece extension set
1/3	TTX918N	8 piece Mega Drive screwdriver set
2/3	TTOS16	16 piece oil service set
2/3	TTM116	16 piece mini plier/screwdriver set
2/3	TTHEX7	7 piece T handle hex drivers
2/3	TTTX7	7 piece T handle TX/TPX drivers
3/3	TT474-7	4 piece 7" circlip plier set
3/3	TT917TXN	7 piece TX/TPX Mega Drive screwdriver set
3/3	TTHEX23	23 piece metric hex bit socket set
3/3	TTX23	23 piece 40/70mm TX bit socket set
1/7	TTX2032	7 piece metric combination spanner set
1/7	TT804	2 in 1 puller set
1/7	TTSN11	11 piece stud and nut remover set
1/7		Selection of general hand tools
2/7	TTX1292	1/2" drive torque wrench with flex handle
2/7	TTTD17	17 piece tap and die set
2/7	TTPC09	9 piece punch and chisel set
2/7	TTHR81	81 piece hand rivet set
2/7	TT9116	16 piece 1/2" drive regular/deep impact socket set
3/7	TTXPB3	3 piece roll bar set
3/7	TTPSPG	4 piece power grip pliers with PS tray
4/7	TTX2640	7 piece AF combination spanner set
4/7	TT3592	8 piece AF combination spanner set
4/7	TTAF32	32 piece 1/4" and 3/8" drive regular/deep AF socket set
4/7	TT1215AF	15 piece 1/2" drive AF regular socket set
4/7	TTALU	32 piece socket clip rail set
5/7	TTX3414	14 piece 3/4" drive metric socket set
5/7	TTX3404	4 piece 3/4" drive accessories
5/7	TTX34AF	14 piece 3/4" drive AF socket set
Side Plate	TCW-SP	10 tool hooks together with 16" water pump pliers, 24" bolt cutters, 18" adjustable wrench, a magnetic tool holder and a magnetic bowl.

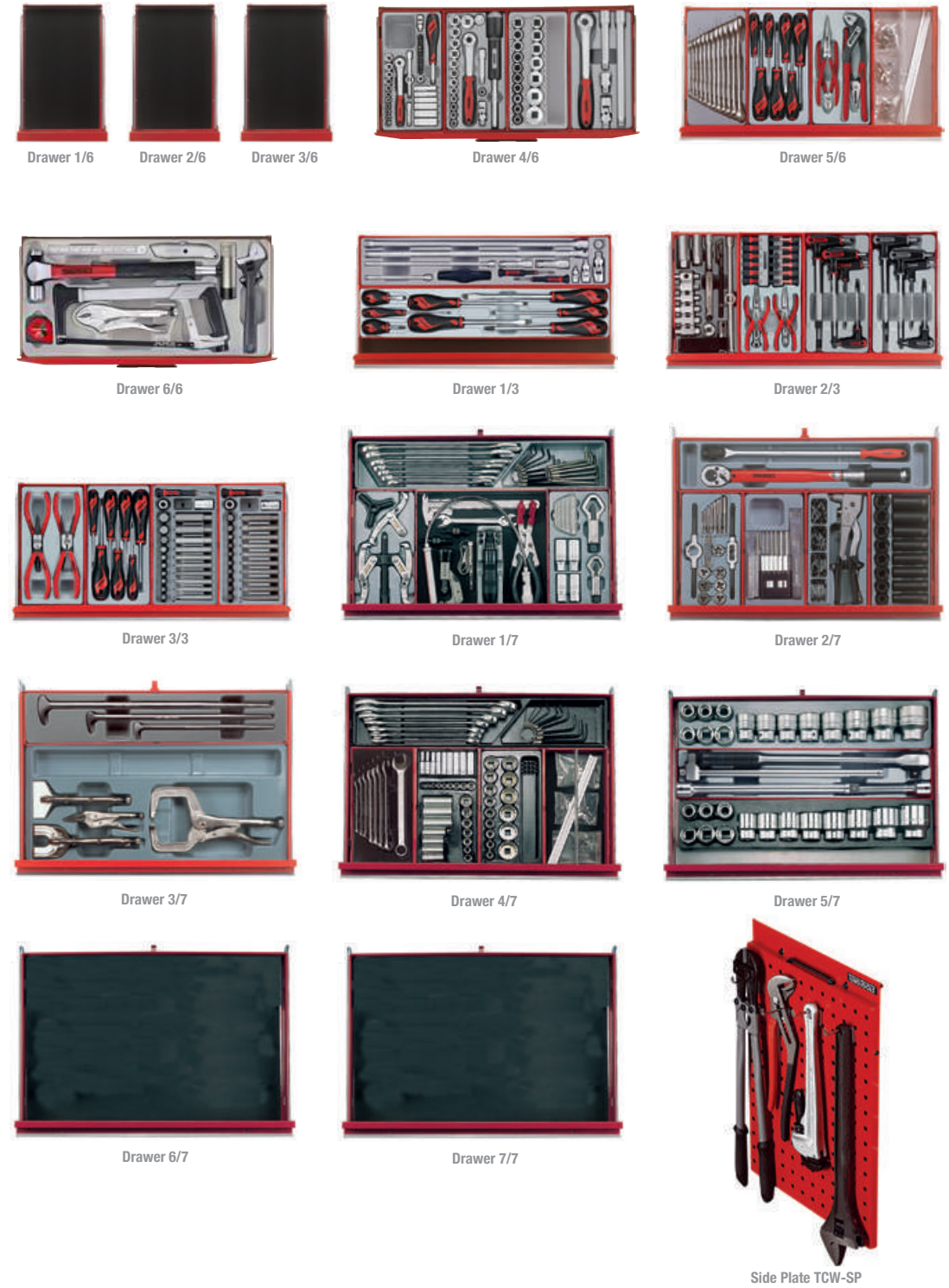

TCMM479 479 Piece Tool Kit

This kit is also available as a 479 piece set which does not include the tools on the side plate or the tools in drawers 4/7 and 5/7. (overall weight 161 kilos)

TCMM569EV 569 Piece Tool Kit

A 569 piece tool kit built up using the Teng Tools TC tray system and the SV tool boxes with a 6 drawer top box, 3 drawer middle box and 7 drawer roller cabinet. (overall weight 130 kilos)

Drawer No	Stock no	Description
4/6	TTDCT05	5 piece cutting tool set
4/6	TT440	4 piece plier set
4/6	TTVG05	5 piece power grip plier set
5/6	TTPC09	9 piece punch and chisel set
5/6	TTCP121	121 piece crimping tool set
5/6	TTD34	34 piece tap and die set
6/6	TTPS09	9 piece general tool set
1/3	TT1435	35 piece 1/4" drive regular/deep metric socket set
1/3	TT3819	19 piece 3/8" drive metric socket set
1/3	TT1218	18 piece 1/2" drive regular metric socket set
1/3	TT1211	11 piece 1/2" drive deep metric socket set
2/3	TT03	Storage tray with 4 compartments
2/3	TT04	Storage tray with 8 compartments
2/3	TTD00	Storage tray with 4 compartments
1/7	TTD01	Storage tray with 8 compartments
1/7	TTD02	Storage tray with 16 compartments
1/7	TTX03	Storage tray with 8 compartments
2/7	TT1236	12 piece metric combination spanner set
2/7	TT6208	8 piece double open ended spanner set
2/7	TTHEX7	7 piece T handle hex wrench set
2/7	TTTX7	7 piece T handle TX wrench set
2/7	TTX2032	7 piece metric combination spanner set
3/7	TTDB28	Fully ground drill bit set (1.0 to 13.0mm)
3/7	TT00	Storage tray with tool clips
3/7	TTHR81	Rivet gun set
3/7	TTTTM08	8 piece inspection tool set
3/7	TTXF05	5 piece hand file set
4/7	TTMD74	74 piece bits driver set
4/7	TT917N	7 piece screwdriver set
4/7	TT917TXN	7 piece TX driver set
4/7	TTHT28	28 piece hex key set
4/7	TTX918N	8 piece screwdriver set

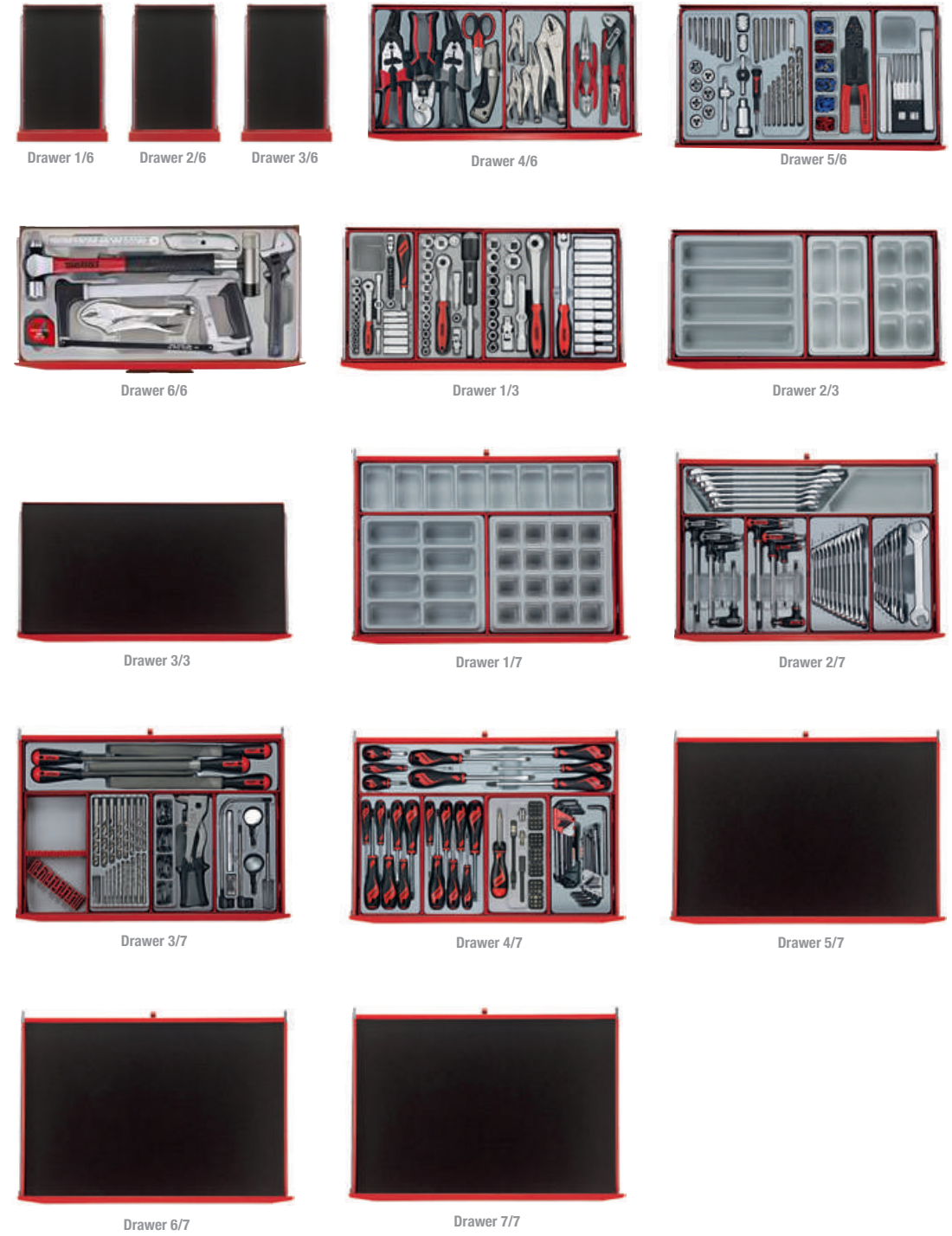

TCMM569EV 569 Piece Tool Kit

Teng Tools

Teng Tools

TCMM622N Work Station NEW!

A comprehensive 622 piece tool kit supplied in the brand new 37" wide TCW207N roller cabinet complete with 7 drawers with individual opening and the new TC-TB03 wooden top plate to create a useful working area. The kit is built up using the Teng Tools TC tray system and incorporates several new sets including the new TTZ trays.

Drawer No	Stock No.	Description
1/7	TTXEXT13	13 piece extension set
1/7	TT1435	35 piece 1/4" drive regular/deep metric socket set
1/7	TT3819	19 piece 3/8" drive metric socket set
1/7	TT1217	17 piece 1/2" drive regular socket set
1/7	TT1205	5 piece 1/2" drive socket accessory set
1/7	TTHEX7	7 piece T handle hex driver set
1/7	TTTX7	7 piece T handle TX driver set
1/7	TTZ01	Add on tool tray
2/7	TTX2032	7 piece combination spanner set
2/7	TT1236	12 piece combination spanner set
2/7	TTSN11	11 piece extractor set
2/7	TTOS16	16 piece oil service kit
2/7	TTM116	16 piece mini tool set
2/7	TT474-7	4 piece 7" circlip plier set
2/7	TT440	4 piece plier set
2/7	TTZVG03	3 piece power grip plier set
3/7	TTX2640	7 piece AF combination spanner set
3/7	TT3592	8 piece AF combination spanner set
3/7	TTAF32	32 piece 1/4" and 3/8" drive regular/deep AF socket set
3/7	TT1215AF	15 piece 1/2" drive regular AF socket set
3/7	TTTX30	30 piece 1/4" and 3/8" drive TX, TPX and TX-E socket set
3/7	TTTD17	17 piece tap and die set
3/7	TT804	4 piece 2 in 1 puller set
3/7	TTZ01	Add on tool tray
4/7	TTX918N	8 piece screwdriver set
4/7	TTPS09	9 piece general tool kit
4/7	TT917N	7 piece screwdriver set
4/7	TT917TXN	7 piece TX/TPX driver set
4/7	TTZ01	Add on tool tray
5/7	TTX1292	1/2" drive torque wrench
5/7	TT9116	16 piece 1/2" drive regular/deep impact socket set
5/7	TTHEX23	23 piece metric hex bit set
5/7	TTALU	32 piece socket clip rail set
5/7	TTTX23	23 piece 40/70mm TX bit socket set
5/7	TTID20	20 piece 1/2" drive impact driver set
5/7	TTMD74	74 piece ratcheting bits driver set
5/7	TTZ01	Add on tool tray
6/7	TTX6311	11 piece metric double ring spanner set
6/7	TTXPB3	3 piece roll/heel bar set
6/7	TTXMB02	2 piece plier and adjustable wrench set
6/7	TTNR81	Nutsert rivet set
6/7	TTPC09	9 piece punch and chisel set
6/7	TTZ01	Add on tool tray



Drawer 1/7



Drawer 2/7



Drawer 3/7



Drawer 4/7



Drawer 5/7



Drawer 6/7



Drawer 7/7

TCMM622N Work Station

TCMM622N Work Station

Drawer No	Stock no	Description
2/9	TTXEXT13	13 piece extension set
2/9	TT1435	35 piece 1/4" drive regular and deep metric socket set
2/9	TT3819	19 piece 3/8" drive regular metric socket set
2/9	TT1205	5 piece 1/2" drive socket accessories
2/9	TT1217	17 piece 1/2" drive regular metric socket set
3/9	TTX474-9	4 piece 9" circlip plier set
3/9	TT440-T	4 piece Mega Bite plier set
3/9	TTVG05	5 piece power grip plier set
3/9	TTDCT05	5 piece cutting tool set
4/9	TTXF05	5 piece 10" file set
4/9	TTTX30	30 piece 1/4" and 3/8" drive TX, TPX and TX-E socket set
4/9	TTBS35	35 piece 1/4" and 3/8" drive TX, TPX and TX-E set
4/9	TTTXH15	15 piece 1/2" drive long bits socket set
4/9	TTRS15	15 piece 1/2" drive RIL and spline bits socket set
5/9	TTX2640	7 piece AF spanner set
5/9	TTAF32	32 piece 1/4" and 3/8" drive regular and deep socket set
5/9	TT1215AF	15 piece 1/2" drive AF regular socket set
5/9	TT3592	8 piece AF combination spanner set
5/9	TT3816	16 piece 3/8" drive deep metric socket set
6/9	TTX918N	8 piece Mega Drive screwdriver set
6/9	TT917N	7 piece Mega Drive screwdriver set
6/9	TT917TXN	7 piece TX/TPX Mega Drive screwdriver set
6/9	TTMD74	74 piece ratchetting bits driver set
6/9	TTDB28	28 piece drill bits set 1-13mm
7/9	TTX2032	7 piece metric combination spanner set
7/9	TT1236	12 piece metric combination spanner set
7/9	TT6508R	8 piece ratchetting combination spanner set
7/9	TT6208	8 piece open ended spanner set
7/9	TT474-7	4 piece 7" circlip plier set
8/9	TTX3404	4 piece 3/4" drive socket accessory set
8/9	TTHT28	28 piece hex and TX key set
8/9	TTHEX7	7 piece T handle hex driver set
8/9	TTTTX7	7 piece T handle TX/TPX driver set
8/9	TTTTM08	8 piece pick up tool set with light
9/9	TTX3414	14 piece 3/4" drive metric socket set
9/9	TT9207	7 piece 1/2" drive impact accessory set
9/9	TT9120D	20 piece 1/2" drive impact regular and deep socket set - DIN standard
9/9	TTID20	20 piece 1/2" drive industrial impact driver set
9/9	TTCM05D	5 piece measuring set

TCMMIND08 569 Piece Tool Kit
 A 569 piece tool kit containing tools for the industrial sector, built up using the unique Teng Tools TC tray system. Supplied in the TCW809N 8 series 9 drawer roller cabinet with a wooden top plate. (overall weight 198 kilos)



Spare Drawer



Drawer 2/9



Drawer 3/9



Drawer 4/9

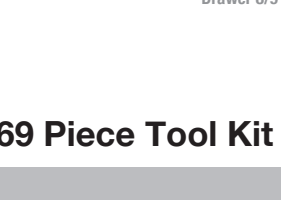

Drawer 5/9



Drawer 6/9

Drawer 7/9

Drawer 8/9

Drawer 9/9

Drawer 9/9

TCMMIND08 569 Piece Tool Kit

TCMM546N 546 Piece Tool Kit
 A 546 piece comprehensive tool kit built up using the unique Teng Tools TC tray system. Supplied in the TCW808N 8 series ball bearing slide 8 drawer roller cabinet. (overall weight 116.5 kilos).

Drawer No	Stock no	Description
1/8	TT1205	5 piece 1/2" drive socket accessory set
1/8	TT1217-6	17 piece 1/2" drive regular metric socket set
1/8	TT1435	35 piece 1/4" drive regular/deep metric socket set
1/8	TT3819	19 piece 3/8" drive regular metric socket set
1/8	TTXEXT13	13 piece extension set
2/8	TT01	Add on tool tray with dividers
2/8	TT917N	7 piece screwdriver set
2/8	TT917TXN	7 piece TX driver set
2/8	TTMD74	74 piece ratchetting bits driver set
2/8	TTXMDTN	5 piece screwdriver set
3/8	TT01	Add on tool tray with dividers
3/8	TTCP121	121 piece crimping plier set
3/8	TTHEX7	7 piece T handle hex key set
3/8	TTHR81	Rivet gun set
3/8	TTX00	Add on tool tray
4/8	TTHT28	28 piece hex and TX key set
4/8	TTMD12D	12 piece screwdriver set
4/8	TTNF12	12 piece needle file set
4/8	TTSR04	4 piece scraper set
4/8	TTXF05	5 piece hand file set
5/8	TT1236	12 piece metric combination spanner set
5/8	TT440-T	4 piece plier set
5/8	TT474-7	4 piece 7" circlip plier set
5/8	TT6208	8 piece metric double open ended spanner set
5/8	TTX2032	7 piece metric combination spanner set
6/8	TT804	4 piece puller set
6/8	TTALU	32 piece socket clip rail set
6/8	TTPC09	9 piece punch and chisel set
6/8	TTTXH15	15 piece 1/2" drive hex and TX socket set
6/8	TTXMDN	9 piece nut driver set
7/8	TTPS09	9 piece general tool kit
7/8	TTX01	Add on tool tray with dividers



Drawer 1/8



Drawer 2/8

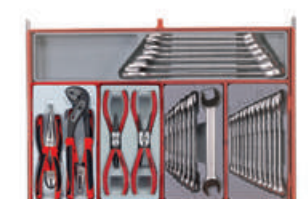

Drawer 3/8

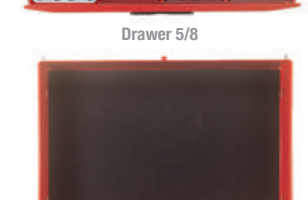

Drawer 4/8

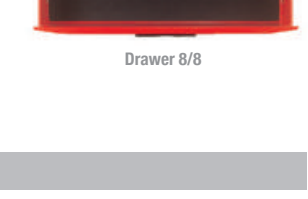

Drawer 5/8



Drawer 6/8

Drawer 7/8

Drawer 8/8

TCMM546N 546 Piece Tool Kit

TCMM545N 545 Piece Tool Kit and Work Station

A 545 piece work station tool kit built up using the unique Teng Tools TC tray system and the Teng Tools wall rack system to put the most frequently used tools near to hand and ready to use. Supplied in the 8 series TCW807N ball bearing slide 7 drawer roller cabinet together with the TC-S01 panel set with 20 assorted hooks (TCW-HK20) and the TC-TB02 wooden top. (overall weight 136.6 kilos).

Drawer No	Stock no	Description
Panel	WRFL05	5 piece file set on a wall rack
Panel	WRMB04	4 piece plier set on a wall rack
Panel	WRMD910N	10 piece screwdriver set on a wall rack
Panel	WRSP12	12 metric combination spanner set on a wall rack
1/7	TTXEXT13	13 piece extension set
1/7	TT1435	35 piece 1/4" drive regular and deep metric socket set
1/7	TT3819	19 piece 3/8" drive regular metric socket set
1/7	TT1218	18 piece 1/2" drive regular metric socket set
1/7	TTTXH15	15 piece 1/2" drive hex and TX bit socket set
2/7	TTXMDTN	5 piece screwdriver set
2/7	TTMD74	74 piece ratcheting bits driver set
2/7	TT917TXN	7 piece TX driver set
2/7	TTHEX7	7 piece T handle hex driver set
2/7	TTTX7	7 piece T handle TX driver set
3/7	TTXMDN	9 piece nut driver set
3/7	TTHR81	Rivet gun set
3/7	TT474-7	4 piece 7" circlip plier set
3/7	TT804	4 piece puller set
3/7	TT01	Add on tool tray with dividers
4/7	TTX00	Add on tool storage tray
4/7	TTPC09	9 piece punch and chisel set
4/7	TTCP121	121 piece crimping tool set
4/7	TTD34	34 piece tap and die set
5/7	TTX2032	7 piece metric combination spanner set
5/7	TTDCT05	5 piece cutting tool set
5/7	TTTM08	8 piece inspection tool kit
5/7	TTM05D	5 piece measuring set
6/7	TTX01	Add on tool tray with dividers
6/7	TTPS09E	9 piece service tool set



Drawer 1/7



Drawer 2/7



Drawer 3/7



Drawer 4/7



Drawer 5/7



Drawer 6/7



Drawer 7/7

TCMM545N 545 Piece Tool Kit and Work Station

Drawer No	Stock no	Description
1/7	TTXMDN	9 piece nut driver set
1/7	TT1435	35 piece 1/4" drive regular/deep socket set
1/7	TT3819	19 piece 3/8" drive regular metric socket set
1/7	TT1236	12 piece metric combination spanner set
1/7	TT6208	8 piece metric double ended spanner set
2/7	TTXMDTN	5 piece power thru screwdriver set
2/7	TTMD74	74 piece ratcheting bits driver set
2/7	TTHEX7	7 piece metric hex T handle driver set
2/7	TT917N	7 piece screwdriver set
2/7	TT917TXN	7 piece TX/TPX screwdriver set
3/7	TTX00	Add on TTX tray
3/7	TT440-T	4 piece mega bite plier set
3/7	TTPC09	9 piece punch and chisel set
3/7	TTCP121	121 piece crimping tool set
3/7	TTTX7	7 piece TX/TPX T handle drivers
4/7	TTX01	Add on tool tray with dividers
4/7	TTPS09	9 piece general tool kit with PS tray
5/7	TTXEXT13	13 piece extension set
5/7	TT1217	17 piece 1/2" drive regular metric 6 point socket set
5/7	TT1205	5 piece 1/2" drive socket accessories
5/7	TTTXH15	15 piece 1/2" drive 100mm long bit socket set
5/7	TTALU	32 piece socket clip rail set
6/7	TTX2032	7 piece metric combination spanner set
6/7	TTHR81	Rivet gun set
6/7	TT804	2 in 1 puller set
6/7	TT474-7	4 piece 7" circlip plier set
6/7	TT01	Add on tool tray with dividers

TCMM491N 491 Piece Tool Kit

A 491 piece general tool kit completely built up using the unique Teng Tools TC tray system, supplied in a TCW807N, 8 series ball bearing roller cabinet. (overall weight 100 kilos).

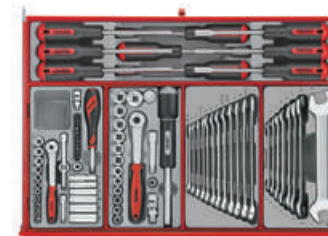

Drawer 1/7



Drawer 2/7



Drawer 3/7



Drawer 4/7



Drawer 5/7

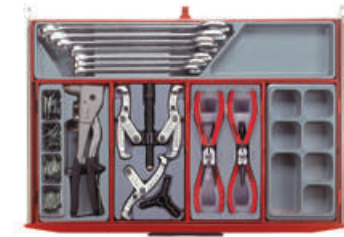

Drawer 6/7



Drawer 7/7

TCMM491N 491 Piece Tool Kit

Teng Tools

Teng Tools

TCMM277EV 277 Piece Tool Kit

A 277 piece starter kit built up using the unique Teng Tools TC tray system and supplied in the TCW707EV 7 drawer ball bearing slide roller cabinet. (overall weight 84 kilos).

Drawer No	Stock no	Description
1/7	TT1435	35 piece 1/4" drive regular and deep metric socket set
1/7	TT3819	19 piece 3/8" drive regular metric socket set
1/7	TT1211	11 piece 1/2" drive deep metric socket set
1/7	TT1218	18 piece 1/2" drive regular metric socket set
1/7	TTXEXT13	3 piece extension set
2/7	TT1236	12 piece metric combination spanner set
2/7	TT6208	8 piece double open ended metric spanner set
2/7	TTHEX7	7 piece T handle hex driver set
2/7	TTTX7	7 piece T handle TX driver set
2/7	TTX2032	7 piece metric combination spanner set
3/7	TT440	4 piece plier set
3/7	TTVG05	5 piece power grip plier set
3/7	TTDCT05	5 piece cutting tool set
3/7	TTX1292	1/2" drive torque wrench
4/7	TTMD74	74 piece bits driver set
4/7	TT917N	7 piece screwdriver set
4/7	TT917TXN	7 piece TX driver set
4/7	TTHT28	28 piece hex and TX key set
4/7	TTX918N	8 piece screwdriver set



TCMM277EV 277 Piece Tool Kit



Drawer 1/7



Drawer 2/7



Drawer 3/7



Drawer 4/7



Drawer 5/7



Drawer 6/7



Drawer 7/7



Drawer 8/7

TC8140NF 140 Piece Tool Kit

140 piece service kit containing 1/4", 3/8" and 1/2" socketry, spanners, pliers, screwdrivers, also including the TTPS09 tray set with adjustable wrenches, power grip pliers, utility knife, hack saw, hammers, a measuring tape and a steel rule. Supplied with the 8 series TC806NF ball bearing slide top box.

Drawer No	Stock No	Description
4/6	TT1435	35 piece 1/4" drive regular/deep metric socket set
4/6	TT3819	19 piece 3/8" drive regular metric socket set
4/6	TT1217	17 piece 1/2" drive regular metric socket set
4/6	TT1205	5 1/2" drive socket accessories
5/6	TT1236	12 metric combination spanners
5/6	TT917N	7 piece Mega Drive screwdriver set
5/6	TT440-T	4 piece Mega Bite plier set
5/6	TTALU	32 piece socket clip rail set
6/6	TTPS09	9 piece general tool kit



TC8140NF 140 Piece Tool Kit



Drawer 4/6



Drawer 5/6



Drawer 6/6

Personalisation & Branding Service

It is now possible to personalise your tool box using vinyl cut stickers. This can be in the format of an image or logo, or may just be your name. This is now available to you through your local stockist. Logos to be supplied as high resolution eps, crr, or ai vector format with cutting path if required.

*Subject to artwork being supplied in the correct format.

TC8140P 140 Piece Personalised Service Case

140 piece service kit based on the regular TC8140NF tool kit. Supplied with the 8 series TC806NGM black ball bearing slide top box. All TC8140P kits are available with the option of having a personalised top box at no extra cost.

Drawer No	Stock No	Description
4/6	TT1435	35 piece 1/4" drive regular/deep metric socket set
4/6	TT3819	19 piece 3/8" drive regular metric socket set
4/6	TT1217	17 piece 1/2" drive regular metric socket set
4/6	TT1205	5 1/2" drive socket accessories
5/6	TT1236	12 metric combination spanners
5/6	TT917N	7 piece Mega Drive screwdriver set
5/6	TT440-T	4 piece Mega Bite plier set
5/6	TTALU	32 piece socket clip rail set
6/6	TTPS09	9 piece general tool kit



Drawer 4/6



Drawer 5/6



Drawer 6/6

TC8140P 140 Piece Personalised Service Kit



TC802B 82 Piece Tool Kit **NEW!**

A tool kit specifically designed for the race track in conjunction with Super One kart driver Jac Maybin and his father Alan using his experience from Formula One to create a tool kit that has all the tools you normally need in the paddock for most racing karts. Supplied with a TC-COVER tool box protective cover for transportation.

Drawer No	Stock No.	Description
4/6	TT1435	35 piece 1/4" drive regular/deep metric socket set
4/6	TT6508R	8 piece ratcheting combination spanner set
4/6	TTHEX7S	7 piece T handle hex driver set
4/6	TT01	Add on tool tray
5/6	TT1236	12 piece metric combination spanner set
5/6	TT917N	7 piece screwdriver set
5/6	TT440-T	4 piece plier set
5/6	TT03	Add on tool tray
6/6	TTPS09	9 piece general tool kit

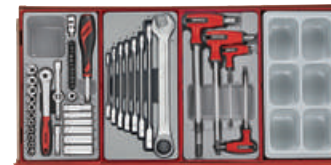

Drawer 4/6



Drawer 5/6



Drawer 6/6

EVA sets

In many activities and situations it is extremely important to be able to quickly check that all tools have been replaced in the correct positions in the tool box at the end of the shift or when the work is completed. The Teng Tools storage system made of EVA foam offers a cost efficient solution.

- Each tool has been scanned in a CAD CAM system and a computer controlled milling machine then cuts out each tool's exact shape in a three-coloured EVA foam block.
- The top layer of the foam is black, the intermediate layer white and the bottom layer red, so that as soon as the tool has been removed its position is clearly visible in red.
- The size and or a description of the tool is etched next to its position. This means that if a tool is missing it is not only its position that is clearly visible, but you can quickly determine which tool is involved. This makes it much easier to remember where you last used the tool and helps when you need to replace a lost tool.
- The EVA inserts fit in Teng Tools roller cabinets and in the extra deep top drawer TC805NFX.
- The range includes 19 EVA sets, 19 TED and 14 TEX.
- Use the unique Teng Tools web-based application to design your tool set, "Click and Fill", at www.tengtools.com to create your own tool set on screen.

EVA SETS



New to the range

- TED - 19 TTD sets with EVA foam inserts and removable cover. These snap together and sit firmly in the Teng Tools roller cabinets and tool boxes. They can also be used as a separate tool box with the cover on.
- TEX - 14 different TTX sets with EVA foam inserts.



Get organised™

TCMME09A 530 Piece EVA Tool Kit

A comprehensive 530 piece tool kit with all the tools laid out in three colour pre-cut EVA foam which clearly shows if any tools are not in their correct place. Supplied in the Teng Tools TC805NFX full depth drawer top box and TCW806N1 6 drawer roller cabinet, all with ball bearing slides. (overall weight 158 kilos)

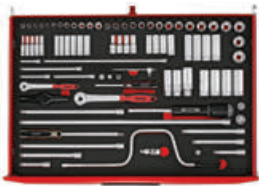

TTESK86
86 piece 1/4" & 3/8" drive socketry

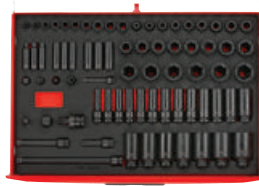

TTEISK73
73 piece 3/8" and 1/2" drive impact socketry



TTESK63
63 piece 1/2" drive regular/deep metric socket set



TTEISK33
33 piece 3/4" drive impact socketry



TTESK32
32 piece 3/4" drive regular metric/AF socket set



TTE23
23 piece nut driver and T handle hex driver set



TTESP31
31 piece metric combination spanner set

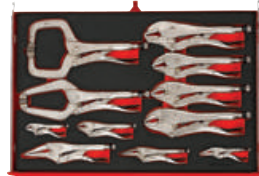

TTEVG11
11 piece power grip plier set



TTEMD122N
122 piece screwdriver set

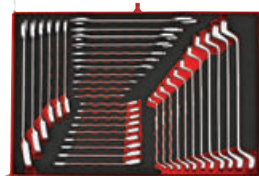

TTESP37
37 piece metric spanner set



TTEMB17
17 piece Mega Bite plier set



TCMME09A 530 Piece Tool Kit

TCEMM417N 417 Piece EVA Tool Kit

A complete 417 piece tool kit with all the tools laid out in three colour pre-cut EVA foam which clearly shows if any tools are not in their correct place. Supplied in the Teng Tools TC806NF top box and TCW807N 7 drawer roller cabinet, all with ball bearing slides. (overall weight 128 kilos)

Drawer No	Stock No	Description
5/6	TEDHEX7	7 piece T handle hex key set
5/6	TEDTX7	7 piece T handle TX key set
1/7	TEXEXT13	13 piece extension set
1/7	TED1489	89 piece 1/4" drive socket set
1/7	TED3836	36 piece 3/8" drive socket set
2/7	TEX1238	3/8" and 1/2" drive torque wrench set
2/7	TED1227	27 piece 1/2" drive socket set
2/7	TED441-T	5 piece plier set
3/7	TEX915N	5 piece screwdriver set
3/7	TED911N	11 piece screwdriver set
3/7	TED909TXN	9 piece TX driver set
4/7	TEXPB4	4 piece roll/heel bar set
4/7	TEDSD95	95 piece torque screwdriver set
4/7	TEDPC14	14 piece punch and chisel set
5/7	TEX2032	7 piece metric combination spanner set
5/7	TED8012	12 piece metric combination spanner set
5/7	TEDADJ4	4 piece adjustable wrench set
6/7	TEXW05	5 piece wheel tool set
6/7	TED9121	21 piece 1/2" drive impact socket set
6/7	TEDHT42	42 piece hex and TX key set



Drawer 5/6

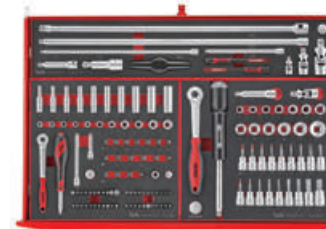

Drawer 1/7



Drawer 2/7



Drawer 3/7



Drawer 4/7



Drawer 5/7



Drawer 6/7



Teng Tools

Teng Tools

Tool Kits with EVA Control System

TCEMM249N 249 Piece EVA Tool Kit

A complete 249 piece tool kit with all the tools laid out in three colour pre-cut EVA foam which clearly shows if any tools are not in their correct place. Supplied in the Teng Tools TC806NF top box and TCW807N 7 drawer roller cabinet, all with ball bearing slides. (overall weight 114 kilos)

Drawer No	Stock No	Description
4/6	TEDV440	4 piece 1000 volt insulated plier set
4/6	TEDV909N	9 piece 1000 volt insulated screwdriver set
5/6	TEDHEX7	7 piece T handle hex key set
5/6	TEDTX7	7 piece T handle TX key set
1/7	TEXEXT13	13 piece extension set
1/7	TED1489	89 piece 1/4" drive socket set
1/7	TED3836	36 piece 3/8" drive socket set
2/7	TEX1238	3/8" and 1/2" drive torque wrench set
2/7	TED1227	27 piece 1/2" drive socket set
2/7	TED441-T	5 piece plier set
3/7	TEX915N	5 piece screwdriver set
3/7	TED911N	11 piece screwdriver set
3/7	TED909TXN	9 piece TX driver set
4/7	TEX2032	7 piece metric combination spanner set
4/7	TED8012	12 piece metric combination spanner set
4/7	TEDADJ4	4 piece adjustable wrench set



Drawer 4/6



Drawer 5/6



Drawer 1/7



Drawer 2/7



Drawer 3/7



Drawer 4/7

Tool Kits with EVA Control System

TCEMM430B 430 Piece Workshop Kit **NEW!**

A tool kit specifically designed for the karting workshop or transporter in conjunction with kartpit.com, the leading on line website for kart maintenance. Based on a six drawer top box and 7 drawer roller cabinet the kit includes just about every tool required for building and maintaining most types of race kart including both gearbox and non-gear box karts. The majority of the trays are from the EVA range which helps keep the tools in place when the kit is travelling in the transporter and the coloured layers make it easy to identify any mislaid tools quickly and easily.

Drawer No	Stock No.	Description
4/6	TEDSD95	95 piece torque screwdriver set
4/6	TEDADJ4	4 piece adjustable wrench set
5/6	TED9121	21 piece 1/2" drive impact socket set
5/6	TEDHT42	42 piece hex and TX key set
6/6	TTCM05D	5 piece measuring tool set
6/6	TTHC03	3 piece hose clamp set
6/6	TDD02	Add on tool tray
1/7	TEDHEX7	7 piece T handle hex key set
1/7	TEDTX7	7 piece T handle TX key set
1/7	TEXEXT13	13 piece extension set
2/7	TED1489	89 piece 1/4" drive socket set
2/7	TED3836	36 piece 3/8" drive socket set
2/7	TEX1238	3/8" and 1/2" drive torque wrench set
3/7	TED1227	27 piece 1/2" drive socket set
3/7	TED441-T	5 piece plier set
3/7	TEXW05	5 piece wheel tool set
4/7	TED911N	11 piece screwdriver set
4/7	TED909TXN	9 piece TX driver set
4/7	TEX915N	5 piece screwdriver set
5/7	TTEPS12	12 piece general tool kit
6/7	TED8012	12 piece metric combination spanner set
6/7	TED6512RS	12 piece ratcheting combination spanner set
6/7	TEX2032	7 piece metric combination spanner set
Accessories	SLT02	Torpedo level
	580	Magnetic bits tray



Drawer 4/6



Drawer 5/6



Drawer 6/6



Drawer 1/7



Drawer 2/7



Drawer 3/7



Drawer 4/7



Drawer 5/7

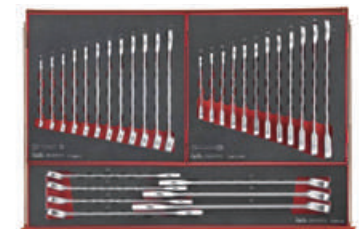

Drawer 6/7

Tool Kits with EVA Control System

TCMME11A 333 Piece EVA Tool Kit

A comprehensive 333 piece tool kit with all the tools laid out in three colour pre-cut EVA foam which clearly shows if any tools are not in their correct place. Supplied in the Teng Toc's TCW807N 7 drawer roller cabinet with ball bearing slides. (overall weight 95 kilos)



TTEM B11 11 piece plier set



TTEM D98N 98 piece screwdriver set



TTEM S12 12 piece set of general tools

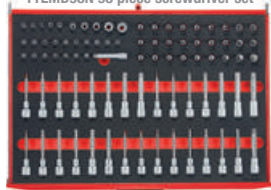

TTEM SK85 85 piece hex sockets and bits set



TTEM SK77 77 piece 1/4", 3/8" and 1/2" drive socketry

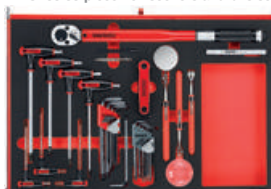

TTEM X17 17 piece hex key, inspection and torque wrench

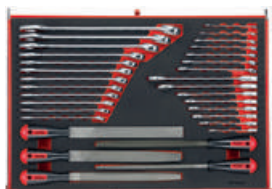

TTEM X32 27 piece spanner set and 5 piece file set



TCMME11A 333 Piece Tool Kit

TCMME09C 280 piece EVA tool kit

A comprehensive 280 piece tool kit with all the tools laid out in three colour pre-cut EVA foam which clearly shows if any tools are not in their correct place. Supplied in the Teng Tools TCW807N 7 drawer roller cabinet with ball bearing slides.



TTEM SK86 86 piece 1/4" & 3/8" drive socketry

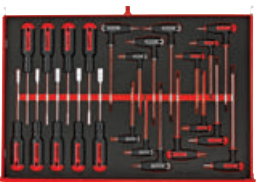

TTEM X23 23 piece nut driver and T handle hex driver set



TTEM SP31 31 piece metric combination spanner set



TTEM B17 17 piece Mega Bite plier set



TTEM D122N 122 piece screwdriver set



TCMME09C 280 Piece Tool Kit

Tool Kits with EVA Control System

TCMME09B 280 Piece EVA Tool Kit

A comprehensive 280 piece tool kit with all the tools laid out in three colour pre-cut EVA foam which clearly shows if any tools are not in their correct place. Supplied in the Teng Tools TC805NFX full depth 5 drawer top box with ball bearing slides.



TTEM SK86 86 piece 1/4" & 3/8" drive socketry

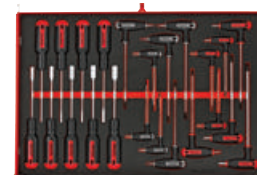

TTEM X23 23 piece nut driver and T handle hex driver set



TTEM D122N 122 piece screwdriver set



TTEM SP31 31 piece metric combination spanner set



TTEM B17 17 piece Mega Bite plier set

TCMME09B 280 Piece Tool Kit



Indoors or outdoors, Teng Tools keeps things going.

TM035NF 35 Piece Tool Kit **NEW!**

- A 35 piece tool kit especially designed for use as a basic set of tools for the workshop or around the home
- Drop front cover
- Ball bearing slide
- Combination lock
- Supplied with rubber feet



Drawer No	Description
Top	1/4" drive regular sockets: 4, 5, 5.5, 6, 7, 8, 10, 12, 13mm 1/4" drive accessories: 2" extension, 1/4" bit ratchet 1/4" male: 1/4" hex adaptor
	1/4" hex bits: 4, 5.5, 6.5mm flat. PH1, PH2, PZ1, PZ2, TX10, TX15, TX20
	Fold up tool set
Drawer 1	6" side cutter, 7" High leverage combination plier
Drawer 2	Combination spanners: 8, 9, 10, 11, 12, 13mm Screwdrivers: flat 5.5x75mm, PH1x75mm insulated PH1x80mm



Top



Drawer 1



Drawer 2

TC144D 144 Piece Portable Service tool Kit

A comprehensive selection of tools for service technicians. Supplied in the TC540 5 cantilever tool box.

Accessories	1/2" drive	FRP ratchet, universal joint, 2 1/2" and 6" extension bars, 3/8" F:1/2" M T bar adaptor
Regular sockets	1/2" drive 12 point	10, 11, 12, 13, 14, 15, 16, 17, 18, 19, 21, 22, 24, 27, 30, 32mm
Accessories	1/4" drive	FRP ratchet, universal joint, 2" and 4" extension bars, coupler adaptor, 3/8" F:1/4" M adaptor
Regular sockets	1/4" drive 6 point	4, 5, 5.5, 6, 7, 8, 10, 11, 12, 13mm
Deep sockets	1/4" drive 6 point	6, 7, 8, 10, 12, 13mm
Bits	1/4" hex	TX10, TX15, TX20, 5mm hex, 6mm hex, PH1, PH2, PZ1, PZ2, 4mm flat, 5.5mm flat
Wrenches		5.5, 6, 7, 8, 9, 10, 11, 12, 13, 14, 15, 16, 17, 18, 19mm combination spanners, 9 piece ball point hex key set, 1.5, 2.0 and 2.5mm hex keys, 10" adjustable wrench
Screwdrivers		3.5mm flat, 5.5mm flat, 6.5mm flat, PH0, PH1, PH2, PZ0, PZ1, PZ2, 4mm flat 1000 volt insulated
Pliers		8" combination, 8" long nose, 10" water pump, 6" side cutters, 8" side cutters, 10" power grip
Service tools		28 piece fully ground drill bit set, magnetic lamp, 3 meter measuring tape, hacksaw with spare blades, utility knife, centre punch, 6 piece parallel pin punch set, soft face hammer, ball pein hammer, tin snips, magnetic bracelet.

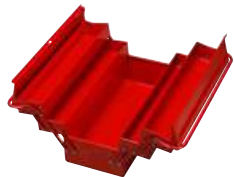

TC144D
144 Piece Portable Service tool Kit

TC144E 144 Piece Portable Service tool Kit

A comprehensive selection of tools for service technicians. Supplied in the TCSB tool bag/back pack.

Accessories	1/2" drive	FRP ratchet, universal joint, 2 1/2" and 6" extension bars, 3/8" F:1/2" M T bar adaptor
Regular sockets	1/2" drive 12 point	10, 11, 12, 13, 14, 15, 16, 17, 18, 19, 21, 22, 24, 27, 30, 32mm
Accessories	1/4" drive	FRP ratchet, universal joint, 2" and 4" extension bars, coupler adaptor, 3/8" F:1/4" M adaptor
Regular sockets	1/4" drive 6 point	4, 5, 5.5, 6, 7, 8, 10, 11, 12, 13mm
Deep sockets	1/4" drive 6 point	6, 7, 8, 10, 12, 13mm
Bits	1/4" hex	TX10, TX15, TX20, 5mm hex, 6mm hex, PH1, PH2, PZ1, PZ2, 4mm flat, 5.5mm flat
Accessories	1/2" drive	FRP ratchet, universal joint, 2 1/2" and 6" extension bars, 3/8" F:1/2" M adaptor
Regular sockets	1/2" drive 12 point	10, 11, 12, 13, 14, 15, 16, 17, 18, 19, 21, 22, 24, 27, 30, 32mm
Wrenches		5.5, 6, 7, 8, 9, 10, 11, 12, 13, 14, 15, 16, 17, 18, 19mm combination spanners, 9 piece ball point hex key set, 1.5, 2.0 and 2.5mm hex keys, 10" adjustable wrench
Screwdrivers		3.5mm flat, 5.5mm flat, 6.5mm flat, PH0, PH1, PH2, PZ0, PZ1, PZ2, 4mm flat 1000 volt insulated
Pliers		8" combination, 8" long nose, 10" water pump, 6" side cutters, 8" side cutters, 10" power grip
Service tools		28 piece fully ground drill bit set, magnetic lamp, 3 meter measuring tape, hacksaw with spare blades, utility knife, centre punch, 6 piece parallel pin punch set, soft face hammer, ball pein hammer, tin snips, magnetic bracelet.



TC144E
144 Piece Portable Service tool Kit

TC045B Carrying Tool Kit **NEW!**

A fully portable tool kit designed in conjunction with leading driver and engine tuner, Scott Allen, of Jade Karts. Based on the versatile Teng Tools TC-SB16 carrying bag but only containing the specific tools that are regularly used by kart race teams. Perfect for carrying to the grid or for practice sessions.



Accessories	1/4" drive	mini ratchet with T handle, bit adaptor
Accessories	3/8" drive	FRP ratchet, 6" extension bar, 16 and 21mm spark plug sockets
Deep sockets	3/8" drive	10, 13, 22mm
Bits	1/4" hex drive	3mm hex (x3)
Combination spanners		8, 10 (x2), 13 (x2), 15, 17 (x2), 19mm
Wrenches		6" adjustable, T handle hex key set including 2.5 to 8mm, 10 and 13mm T handle nut drivers
Screwdrivers		PH2 x 100mm, 3mm flat x 75mm, 5mm flat x 150mm
Pliers		5" flush cut, 5" inner/bent circlip, 5" outer/bent circlip, 6" side cutters, 7" combination
Cutting tools		scissors, utility knife
Hammers		soft face and 12oz ball pein
Measuring tools		3 meter tape measure and 200mm steel rule



TC187 187 Piece Mechanics Kit

Complete Mega Rosso mechanics kit including 1/4", 3/8" and 1/2" drive socket sets and combination spanners in a barn style box with unique socket storage. (450x200x200mm, 11.0 kilos)

Accessories	1/4" drive	30 socket clips, FRP ratchet, universal joint, 2" and 4" extensions, 3/8"F:1/4"M adaptor, coupler adaptor
Accessories	3/8" drive	30 socket clips, FRP ratchet, universal joint, 6" extension, 1/2"F:3/8"M adaptor
Accessories	1/2" drive	30 socket clips, FRP ratchet, universal joint, 2 1/2" and 6" extensions, 3/8"F:1/2"M adaptor
Regular sockets	1/4" drive 6 point	4, 5, 5.5, 6, 7, 8, 10, 11, 12, 13mm
Deep sockets	1/4" drive 6 point	6, 7, 8, 10, 12, 13mm
Regular sockets	3/8" drive 6 point	8, 9, 10, 11, 12, 13, 14, 15, 16, 17, 18, 19, 21, 22mm
Regular sockets	1/2" drive 12 point	10, 11, 12, 13, 14, 15, 16, 17, 18, 19, 21, 22, 24, 27, 30, 32mm
Bits	1/4" hex	TX8, TX10, TX15, TX20, TX25, TX27, TX30, TX40, 3mm hex, 4mm hex, 5mm hex, 6mm hex, 7mm hex, 8mm hex, 10mm hex, PH1, PH2, PZ1, PZ2, 4mm flat, 5.5mm flat, 7mm flat.
Wrenches		8, 10, 11, 12, 13, 14, 15, 17, 19mm combination spanners, ring holder, 1.5, 2.0, 2.5mm hex keys



T3848 48 Piece 3/8" Drive Tool Set

48 piece 3/8" drive set containing 6 point regular metric and AF sockets, 2 spark plug sockets, 14 combination spanners, 6 screwdrivers, 5 pliers, adjustable wrench, FRP ratchet, 3" and 6" extension bars, coupler adaptor and 1/2"-3/8" adaptor. Supplied in a plastic carrying case with latch lid, retractable handle and metal pin hinges. The underside of the case is fitted with rubber feet to prevent it from sliding. (466x258x105mm, 6.51 kilos)

Accessories	3/8" drive	FRP Ratchet, universal joint, 3" and 6" extension bars, coupler adaptor, 1/2"F:3/8"M adaptor, 16 and 21mm spark plug sockets
Regular sockets	3/8" drive 6 point	7/16" 1/2" 9/16" 11/16"
	6 point	8, 10, 12, 13, 14, 15, 16, 17, 18, 19mm
Combination spanners	AF	7/16" 1/2" 9/16" 11/16"
	mm	8, 10, 12, 13, 14, 15, 16, 17, 18, 19mm
Screwdrivers		3.0mm flat, 5.5mm flat, 6.5mm flat, PH0, PH1, PH2,
Pliers		6" side cutter, 7" combination, 8" long nose, 10" water pump
Power grip pliers		7" curved jaw
Adjustable wrenches		8" phosphate finish



T3867 67 Piece 3/8" drive Tool Set

67 piece 3/8" drive tool set containing regular 6 point metric sockets, FRP ratchet, universal joint, 3" and 6" extension bars, coupler adaptor, 1/2"- 3/8" adaptor, bits driver with magnetic bits holder, 10 combination spanners, 6 screwdrivers, 4 pliers as well as 26 bits. Supplied in a plastic carrying case with latch lid, retractable handle and metal pin hinges. The underside of the case is fitted with rubber feet to prevent it from sliding. (466x258x103mm, 5.44 kilos)

Accessories	3/8" drive	FRP ratchet, 3" & 6" extensions, coupler adaptor, 1/2"F:3/8"M T-bar adaptor, bits driver handle with magnetic bits holder
Regular sockets	3/8" drive 6 point	8, 9, 10, 11, 12, 13, 14, 15, 16, 17, 18, 19, 20, 22mm
Combination spanners		8, 10, 11, 12, 13, 14, 15, 16, 17, 19mm
Screwdrivers		3.0mm flat, 5mm flat, 6mm flat, PH0, PH1, PH2,
Pliers		6" side cutter, 7" combination, 8" long nose, 10" water pump
Bits	1/4" hex	TX8, TX10, TX15, TX20, TX25, TX27, TX30, TX40, TX45, TX50, 3mm hex, 4mm hex, 5mm hex, 6mm hex, 8mm hex, 10mm hex, PH0, PH1, PH2, PH3, PZ1, PZ2, PZ3, 4mm flat, 5.5mm flat, 7mm flat

TM079 79 Piece 3/8" Tool Set

79 piece 3/8" socket and tool set. A service kit that contains a 3/8" drive socket set with FRP ratchet, bit sockets, universal joint, adaptor drive 1/2" x 3/8". Also included are: bit screwdriver with magnet, LED torch, measuring tape, universal knife, telescopic magnetic pick up, hook set for O-rings, universal pliers, carpenters hammer with steel tube handle, 1/4" adaptor, 3/8" drive sockets, combination spanners, hex key set, adjustable wrench, flat nose pliers, side cutters, combination pliers, water pump pliers, screwdrivers and 20 bits. Supplied in a plastic carrying case with latch lid, retractable handle and metal pin hinges. The underside of the case is fitted with rubber feet to prevent it from sliding. (466x258x103mm, 6.8 kilos)



Accessories	3/8" drive	FRP ratchet, 5" extension, universal joint, 1/2"F:3/8"M T-bar adaptor, bits driver handle with magnetic bits holder
		1/4" hex adaptor, LED light with clip, 5m measuring tape, utility knife, telescopic magnet, 4 in 1 hook and pick set, gun saw, 16oz claw hammer
Regular sockets	3/8" drive 6 point	8, 10, 11, 12, 13, 14, 15, 17, 19, 20, 21, 22mm
Combination spanners		6, 7, 8, 10, 11mm
Hex key set		7 piece folding hex key set 1.5-6mm
Adjustable wrench		8" wide opening with vinyl grip
Screwdrivers		3.0mm flat, 5.5mm flat, PH1, PH2,
Pliers		6" side cutter, 7" combination, 6" long nose, 7" water pump
Bits	1/4" hex	TX10, TX15, TX20, TX25, TX27, TX30, TX40, TPX20, TPX25, TPX30, 4mm hex, 5mm hex, 6mm hex, PH1, PH2, PH3, PZ1, PZ2, PZ3, 4.5mm flat, 5.5mm flat, 6.5mm flat, ROB no1, ROB no2, ROB no3, GR no2(x2)

TM079E 79 Piece 3/8" Tool Set

79 piece 3/8" socket and tool set. A service kit that contains a 3/8" drive socket set with FRP ratchet, bit sockets, universal joint, adaptor drive 1/2" x 3/8". Also included are: bit screwdriver with magnet, LED torch, measuring tape, universal knife, telescopic magnetic pick up, hook set for O-rings, universal pliers, engineers hammer, 1/4" adapter, 3/8" drive sockets, combination spanners, hex key set, adjustable wrench, flat nose pliers, side cutters, combination pliers, water pump pliers, screwdrivers and 20 bits. Supplied in a plastic carrying case with latch lid, retractable handle and metal pin hinges. The underside of the case is fitted with rubber feet to prevent it from sliding. (466x258x103mm, 6.8 kilos)



Accessories	3/8" drive	FRP ratchet, 5" extension, universal joint, 1/2"F:3/8"M T-bar adaptor, bits driver handle with magnetic bits holder
		1/4" hex adaptor, LED light with clip, 5m measuring tape, utility knife, telescopic magnet, 4 in 1 hook and pick set, gun saw, 500g engineers hammer
Regular sockets	3/8" drive 6 point	8, 10, 11, 12, 13, 14, 15, 17, 19, 20, 21, 22mm
Combination spanners		6, 7, 8, 10, 11mm
Hex key set		7 piece folding hex key set 1.5-6mm
Adjustable wrench		8" wide opening with vinyl grip
Screwdrivers		3.0mm flat, 5.5mm flat, PH1, PH2,
Pliers		6" side cutter, 7" combination, 6" long nose, 7" water pump
Bits	1/4" hex	TX10, TX15, TX20, TX25, TX27, TX30, TX40, TPX20, TPX25, TPX30, 4mm hex, 5mm hex, 6mm hex, PH1, PH2, PH3, PZ1, PZ2, PZ3, 4.5mm flat, 5.5mm flat, 6.5mm flat, ROB no1, ROB no2, ROB no3, GR no2(x2)

T1268 1/2" Drive Tool Set

68 piece 1/2" drive tool set, containing 16 regular 12 point metric sockets, FRP ratchet, universal joint, 2 1/2" and 6" extension bars, adaptor 3/8" F - 1/2" M, bits holder with magnetic bits holder, 10 combination spanners, 6 screwdrivers, 4 pliers as well as 26 bits. Supplied in a plastic carrying case with latch lid, retractable handle and metal pin hinges. The underside of the case is fitted with rubber feet to prevent it from sliding. (466x258x103mm, 6.72 kilos)

Accessories	1/2" drive	FRP ratchet, 2 1/2" & 6" extensions, universal joint, 1/2"F:3/8"M T-bar adaptor, bits driver handle with magnetic bits holder
Regular sockets	1/2" drive 12 point	10, 11, 12, 13, 14, 15, 16, 17, 18, 19, 21, 22, 27, 30, 32mm
Combination spanners		8, 10, 11, 12, 13, 14, 15, 16, 17, 19mm
Screwdrivers		3.0mm flat, 5.5mm flat, 6.6mm flat, PH0, PH1, PH2,
Pliers		6" side cutter, 7" combination, 8" long nose, 10" water pump
Bits 25mm	1/4" hex	TX8, TX10, TX15, TX20, TX25, TX27, TX30, TX40, TX45, TX50, 3mm hex, 4mm hex, 5mm hex, 6mm hex, 8mm hex, PH0, PH1, PH2, PH3, PZ1, PZ2, PZ3, 4mm flat, 5.5mm flat, 7mm flat



Tool Kits

TM095 1/4" and 1/2" Drive Socket and Tool Set

95 piece 1/4" and 1/2" drive socket set containing regular and deep 1/4" drive metric sockets, 1/2" drive regular 6 point sockets, FRP ratchets, universal joints, extension bars, 1/2" drive spark plug sockets and other socket accessories and screwdriver bits. The set also includes combination spanners and screwdrivers. Supplied in a plastic carrying case with latch lid, retractable handle and metal pin hinges. The underside of the case is fitted with rubber feet to prevent it from sliding. (466x258x103mm, 6.3 kilos)

Accessories	1/4" drive		FRP ratchet, universal joint, 2" and 4" extensions, sliding T bar, spinner handle, coupler adaptor, 50mm magnetic bit holder
Regular sockets	1/4" drive	6 point	4, 4.5, 5, 5.5, 6, 7, 8, 9, 10, 11, 12, 13mm
Deep sockets	1/4" drive	6 point	4, 5, 6, 7, 8, 9, 10, 11, 12, 13mm
Regular sockets	1/2" drive	6 point	10, 11, 12, 13, 14, 15, 17, 19, 22, 24, 27, 30, 32mm
Accessories	1/2" drive		FRP ratchet, 5" and 10" extensions, 3/8" F:1/2" M T bar adaptor, universal joint, 5/16" hex coupler adaptor, 21mm spark plug socket
Combination spanners			8, 10, 12, 13, 14, 17mm
Screwdrivers			PH1x75mm, PH2x100mm, PZ1x75mm, PZ2x100mm, 3mm flat x 75mm, 4mm flat x 100mm
Bits (25mm)	1/4" hex		4, 5.5 and 7mm flat, PH0, PH1, PH2, PH3, PH4, PZ0, PZ1, PZ2, PZ3, 3, 4, 5, 6, 8 and 10mm hexagon, 1/4" male adaptor, TX8, TX10, TX15, TX20, TX25 TX27, TX30, TX40
Bits (30mm)	5/16" hex		TX45, TX50, TX55



TM106 106 Piece 1/4" 3/8" & 1/2" Drive Socket Set

106 piece professional tool set, containing 1/4" and 3/8" drive regular 6 point sockets, 1/4" drive deep sockets, 3/8" drive spark plug sockets, 1/2" drive regular 12 point sockets, FRP ratchets, universal joints coupler adaptors, extension bars, bi-flex wrench, bit driver, adaptors, double flex wrenches, combination spanners, ring holder, adjustable wrench and a full range of screwdriver bits. Supplied in a plastic carrying case with latch lid, retractable handle and metal pin hinges. The underside of the case is fitted with rubber feet to prevent it from sliding. (466x258x103mm, 7.85 kilos)



Accessories	1/4" drive		FRP ratchet, bi-flex wrench, universal joint, 2" & 3" extensions, coupler adaptor, bits driver handle with magnetic bits holder
Accessories	3/8" drive		FRP ratchet, 3" & 6" extensions, universal joint, 3/8" F:1/4" M T bar adaptor, 3/8" F:1/2" M T bar adaptor, coupler adaptor
Accessories	1/2" drive		2 1/2" & 10" extensions, 1 1/2" F:3/8" M T bar adaptor, flex head adaptor
Regular sockets	1/4" drive	6 point	4, 5, 6, 7, 8, 10, 12, 13mm
Deep sockets	1/4" drive	6 point	6, 7, 8, 10, 12, 13mm
Regular sockets	3/8" drive	6 point	8, 9, 10, 12, 13, 14, 15, 16, 17, 18, 19, 21, 22mm
Spark plug sockets	3/8" drive		16, 21mm
Regular sockets	1/2" drive	12 point	19, 24, 27, 30, 32mm
Bits (25mm)	1/4" hex		TX8, TX10, TX15, TX20, TX25, TX27, TX30, TX40, TPX10, TPX15, TPX20, TPX25, TPX27, TPX30, TPX40 3mm hex, 4mm hex, 5mm, 6mm hex, 8mm hex, 10mm hex, PH0, PH1, PH2, PH3, PZ1, PZ2, PZ3, 4mm flat, 5.5mm flat, 7mm flat, XZN M5, XZN M6
Wrenches			8, 9, 10, 11, 12, 13, 14, 15, 16, 17, 18, 19mm combination spanners, ring holder, 8x9mm, 10x11mm, 12x13mm, 14x15mm double flex wrenches, 10" adjustable

TM127 1/4", 3/8" and 1/2" Drive Metric and AF Socket and Tool Set

127 piece 1/4", 3/8" and 1/2" drive socket set containing regular and deep 1/4" drive sockets, 3/8" and 1/2" drive regular sockets, FRP ratchets, extension bars, universal joints, spark plug sockets, adaptors and screwdriver bits. The set also includes combination spanners, an adjustable wrench and a ratcheting bits driver. Supplied in a plastic carrying case with latch lid, retractable handle and metal pin hinges. The underside of the case is fitted with rubber feet to prevent it from sliding. (466x258x105mm, 7.5 kilos)

Accessories	1/4" drive		FRP ratchet, universal joint, 2" and 3" extension bars, coupler adaptor
Regular sockets	1/4" drive	6 point	4, 5, 5.5, 6, 7, 8, 10, 11, 12, 13mm
Deep sockets	1/4" drive	6 point	3/16", 7/32", 1/4", 9/32", 5/16", 11/32", 3/8", 7/16", 1/2"
Accessories	3/8" drive		FRP ratchet, universal joint, 3" and 6" extension bars, coupler adaptor, 16 and 21mm spark plug sockets, 3/8" F:1/4" M adaptor, 3/8" F:1/2" M adaptor
Regular sockets	3/8" drive	6 point	8, 9, 10, 11, 12, 13, 14, 15, 16, 17, 18, 19, 21, 22mm
Accessories	1/2" drive		5/16", 3/8", 7/16", 1/2", 9/16", 5/8", 11/16", 3/4", 13/16", 7/8"
Accessories	1/2" drive		2 1/2" and 10" extension bars, flex head adaptor, 1/2" F:3/8" M adaptor
Regular sockets	1/2" drive	12 point	19, 24, 27, 30, 32mm
Wrenches			8, 9, 10, 11, 12, 13, 14, 15, 16, 17, 18, 19mm combination spanners, spanner ring, 8" adjustable wrench
Bits	1/4" hex		Ratcheting bits driver, 4mm (x 2), 5.5mm (x 2) and 7mm flat (x 2), PH0, PH1 (x 2) PH2 (x 2), PH3, PZ1 (x 2), PZ2 (x 2), PZ3, 1/4" M adaptor, 3, 4, 5, 6, 8, 10mm hex, 1/8", 9/64", 5/32", 3/16", 1/4", 3/8" hex, TX8, TX10, TX15, TX20, TX25, TX27, TX30, TX40, 5 and 6 XZN.



LIKE CLOCKWORK ACCORDING TO TENG



ANNA, Maintenance Engineer

Production stops make for a bad day. You want the manufacturing process to flow like it should. To get that, you need a perfectly tuned workstation. For some, things organised perfectly might seem boring, but when it comes to get things to run like clockwork, it's vital. Welcome to our world!

Teng Tools



CASE

- A moulded robust plastic body makes the case strong and stable.
- The transport castors are made of rubber making the case easy to pull and prevent it from sliding.
- The retractable telescopic handle is a comfortable length that makes it easy to pull the case.
- The case is equipped with a code lock to protect your tools.
- The rubber feet mean the case does not slide around or damage painted surfaces.
- Carrying handles on the short and long sides to satisfy all needs.

TOOL STORAGE

- A part of the Teng Tools tool storage system that holds a total of nine TT sets with three TT sets in each compartment.
- Each compartment has a transparent lid, so that you have a clear view of the tools and so that they are held in place when transporting the case.
- The centre compartment sits loose in the case and can be easily lifted out when you need your tools.

YOUR CHOICE

- Four suggested complete mobile tool sets that suit most users.

The case is also available without tools, so that you can choose any combination from the Teng Tools range of more than 160 different TT sets to create your own personal set of tools.

- Go to www.tengtools.com and "Click & Fill" to create your own personal content for your service case.

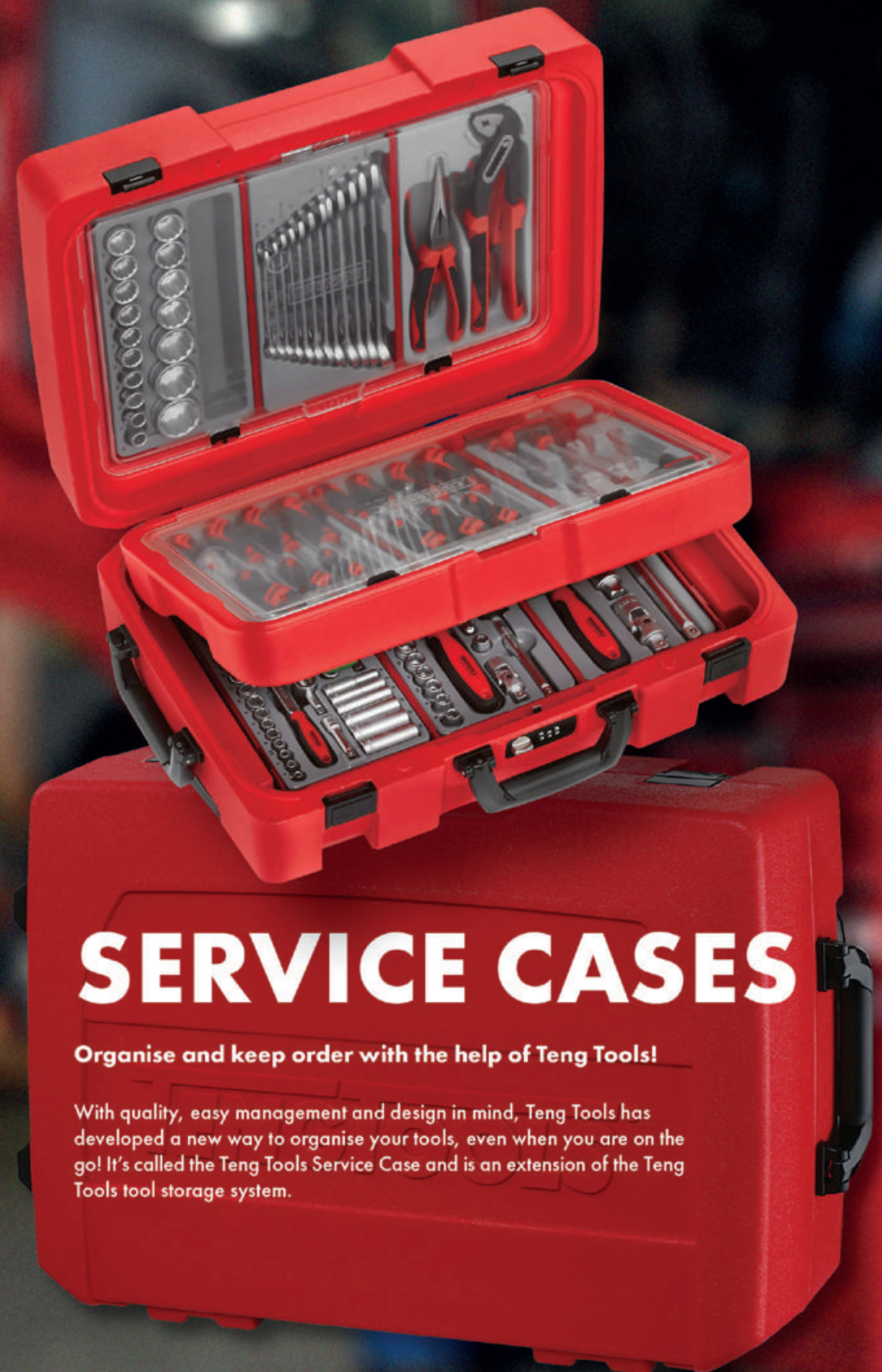

SERVICE CASES

Organise and keep order with the help of Teng Tools!

With quality, easy management and design in mind, Teng Tools has developed a new way to organise your tools, even when you are on the go! It's called the Teng Tools Service Case and is an extension of the Teng Tools tool storage system.

SC01 Service Case Kit 1

Fully portable tool kit supplied in a hard wearing flight case style carrying case complete with suspension wheels, retractable handle, combination lock. The kit includes 9 Teng Tools TC trays. Included in the kit are 1/4", 3/8" and 1/2" drive socket sets, combination spanners, pliers, screwdrivers, TX drivers and T handle hex keys. (500x400x240mm, 15.75 kilos)



Compartment No	Stock No	Description
1/3	TT1217	17 piece 1/2" drive regular metric socket set
1/3	TT1236	12 metric combination spanners
1/3	TT440-T	4 piece Mega Bite plier set
2/3	TT917N	7 piece Mega Drive screwdriver set
2/3	TT917TXN	7 piece Mega Drive TX/TPX screwdriver set
2/3	TTHEX7	7 piece metric T Handle hex key set
3/3	TT1435	5 piece 1/4" drive regular/deep metric socket set
3/3	TT3819	19 piece 3/8" drive regular metric socket set
3/3	TT1205	5 1/2" drive socket accessory set



Compartment 1



Compartment 2



Compartment 3

SC02 Service Case Kit 2

Fully portable kit supplied in a hard wearing flight case style carrying case complete with suspension wheels, retractable handle, combination lock. The kit includes 9 Teng Tools TC trays. Included in the kit are various plier and screwdriver sets as well as drill bits, inspection tools, files, hex keys and ratcheting combination spanners. (500x400x240mm, 14.4 kilos)



Compartment No	Stock No	Description
1/3	TT440	4 piece Mega Bite plier set
1/3	TTMI16	16 piece mini plier and screwdriver set
1/3	TTCP121	crimping plier with terminals and connectors
2/3	TTTM03	3 piece inspection tool set
2/3	TTNF12	12 piece needle file set
2/3	TTDB28	28 piece fully ground drill bit set
3/3	TT6508R	8 piece metric ratcheting combination spanner set
3/3	TTHT28	28 piece hex and TX key set
3/3	TTMD12D	12 piece double ended screwdriver set



Compartment 1



Compartment 2



Compartment 3

SC03 Service Case Kit 3

Fully portable tool kit supplied in a hard wearing flight case style carrying case complete with suspension wheels, retractable handle and combination lock. The kit includes 9 Teng Tools TC trays. Included in the kit are pliers, screwdrivers, 1/4" drive socketry and inspection tools. (500x400x240mm, 14.5 kilos)



Compartment No	Stock No	Description
1/3	TT440	4 piece plier set
1/3	TTMI16	16 piece mini plier and screwdriver set
1/3	TTMD12D	12 piece screwdriver set
2/3	TT917N	7 piece screwdriver set
2/3	TT917TXN	7 piece TX driver set
2/3	TTMD74	74 piece ratcheting bits driver set
3/3	TT1435	35 piece 1/4" drive regular and deep metric socket set
3/3	TTBS35	35 piece 1/4" drive bit socket set
3/3	TTTM03	3 piece inspection tool set



Compartment 1



Compartment 2



Compartment 3

SC04 Service Case Kit 4

Fully portable tool kit supplied in a hard wearing flight case style carrying case complete with suspension wheels, retractable handle, combination lock. The kit includes 9 Teng Tools TC trays. Included in the kit are 1/4", 3/8" and 1/2" drive socket sets, combination spanners, pliers, screwdrivers, and a 6 piece general service kit. (500x400x240mm, 17.66 kilos)



Compartment No	Stock No	Description
1/3	TT1236	12 piece combination spanner set
1/3	TT917N	7 piece Mega Drive screwdriver set
1/3	TT440-T	4 piece Mega Bite plier set
2/3	SCPS01	6 piece service tool set with ball peen hammer
3/3	TT1435	35 piece 1/4" drive regular/deep metric socket set
3/3	TT3819	19 piece 3/8" drive regular metric socket set
3/3	TT1218	17 piece 1/2" drive regular metric socket set



Compartment 1



Compartment 2



Compartment 3

SC04E Service Case Kit 4 (option E)

Fully portable tool kit supplied in a hard wearing flight case style carrying case complete with suspension wheels, retractable handle, combination lock. The kit includes 9 Teng Tools TC trays. Included in the kit are 1/4", 3/8" and 1/2" drive socket sets, combination spanners, pliers, screwdrivers, and a 6 piece general service kit. (500x400x240mm, 17.66 kilos)

Compartment No	Stock No	Description
1/3	TT1236	12 piece combination spanner set
1/3	TT917N	7 piece Mega Drive screwdriver set
1/3	TT440-T	4 piece Mega Bite plier set
2/3	SCPS01E	6 piece service tool set with engineers hammer
3/3	TT1435	35 piece 1/4" drive regular/deep metric socket set
3/3	TT3819	19 piece 3/8" drive regular metric socket set
3/3	TT1218	17 piece 1/2" drive regular metric socket set



Compartment 1



Compartment 2



Compartment 3



SC058B Karting Tool Kit NEW!

A fully portable tool kit designed for race day in conjunction with Super One kart driver Jac Maybin and his father using his experience from Formula One to create a tool kit that has all the tools that are needed at the race track for last minute adjustments and repairs. Based on the popular TC-SC service set carrying case and using the Teng Tools tool control system.

Compartment No	Stock No	Description
1/3	TT1435	35 piece 1/4" drive socket set
1/3	TT01	storage tray with 7 compartments
1/3	TT1236	12 piece metric combination spanner set
2/3	TT917N	7 piece screwdriver set
2/3	TT440-T	4 piece plier set
2/3	TT03	storage tray with 4 compartments



Compartment 1/3



Compartment 2/3

SC083B Portable Tool Kit NEW!

A fully portable tool kit designed in conjunction with leading driver and engine tuner, Scott Allen, of Jade Karts. Based on the popular Teng Tools TC-SC service set carrying case but only containing the tools that are regularly used by kart race teams.

Compartment No	Stock No.	Description
1/3	TT917N	7 piece screwdriver set
1/3	TT440-T	4 piece plier set
1/3	TT474-5	4 piece circlip plier set
2/3	TT00	Add on tool tray
2/3	TTALU	32 piece clip rail set tool tray
2/3	TTHEX7	7 piece T handle hex key set
3/3	various	metric combination spanners including 8, 10 (x2), 13 (x2), 15, 17 (x2) and 19mm, 3/8" drive FRP ratchet together with a 6" extension bar, 16 and 21mm spark plug sockets plus 10, 13 and 22mm deep sockets, a 1400M 1/4" drive mini ratchet with bit adaptor and 3 x 3mm hex bits, flush cut pliers, scissors, soft face hammer, ball pein hammer, 10 and 13mm nut drivers, a 3 meter measuring tape and a 200mm steel rule.



Compartment 1/3



Compartment 2/3

SCPS01 6 Piece Service Tool Set

Service tray with 3 meter measuring tape, 12" hacksaw frame, utility knife, 10" power grip plier, 8" adjustable wrench and a 16oz ball pein hammer. Supplied in a PS tray to fit in the Teng Tools TC-SC service case. (420x265x56mm, 2.5 kilos)

Measuring tape, hacksaw frame, utility knife, power grip plier, adjustable wrench, ball pein hammer.



SCPS01E 6 Piece Service Tool Set

Service tray with 3 meter measuring tape, 12" hacksaw frame, utility knife, 10" power grip plier, 8" adjustable wrench and a 500g engineers hammer. Supplied in a PS tray to fit in the Teng Tools service case. (420x265x56mm, 2.5 kilos)

Measuring tape, hacksaw frame, utility knife, power grip plier, adjustable wrench, engineers hammer.



TOOL STORAGE

Teng Tools tool boxes and roller cabinets have been designed to meet the high demands made by quality conscious professionals from all over the world. No details are left to chance when our tool boxes and roller cabinets are manufactured. The range comprises 8 top boxes, 2 middle boxes, 11 different roller cabinets and 5 side cabinets. These can all be combined with Teng Tools tool storage systems with over 160 different TT trays in various sizes.



New to the range: Roller cabinet TCW907X

- 7 drawers with ball-bearing slides, each drawer has individual closing (a small strip in the handle is lifted up to open) – this means the drawer cannot be opened or left open accidentally.
- All drawers feature soft closing. Even if you close the drawer firmly, it slides in smoothly.



- Side handles on all top and middle boxes are rubber coated, which gives a comfortable grip when the boxes need to be carried.
- All roller cabinets are equipped with rubberised transport handles so that it is easier to move them and the handles feature a soft comfortable grip.
- All Teng Tools tool boxes and roller cabinets are made of strong, high quality steel, which gives the drawers a longer life and greater stability. The drawers are powder coated with rust protection in five stages as well as an under coat that extends the life of the surface finish.
- Most Teng Tools roller cabinets are equipped with 5" stable castors, which makes them easy to move. The wider cabinets are equipped with 6" castors. The castors are positioned in the corners of a U-shaped castor frame, which provides extra strength and stability.
- All drawers are equipped with three-step ball bearing slides so the drawers are easy to open and are also fully extendable, which gives better access to the tools.
- The manufacturing method used means the top and middle boxes have a capacity of 20 kg and for the roller cabinets 25, 30, or 40 kilos.
- All drawers are fitted with foam inserts to minimise scratching and to prevent loose tools from sliding around.
- Improved locking system for extra security where most tool boxes and roller cabinets now feature a code lock.
- All top boxes with the famous Teng Tools' eye logo, which makes the tool box more distinctive and striking.
- A full range of accessories is available including side tables and cabinets, drawer dividers and TC trays.
- Now there is also a more standard basic version of the roller cabinet, middle and top boxes, with the same high, Teng Tools quality, but with fewer extra accessories and 4" castors on the roller cabinet.

TOOL STORAGE

Teng Tools has a wide range of roller cabinets and drawers for tool storage.

To make it even more complete, we have added a series of side tables, shelves and accessories where you can store your tools and any other things you may need. All to help you keep order so you can do a good job.



TC803N



TC805NFX



TC806NF



Pimp your tool trolley!



Shelf with hooks
TCT02

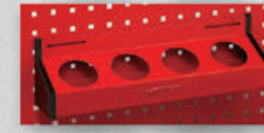

Shelf for aerosols, with hooks
TCC02



LED light panel
589ME

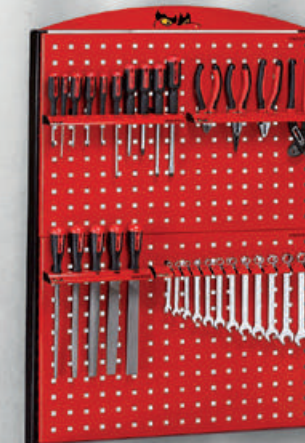

TC-S01



TCB80A



Tool holder
TCT04



TCB80

- Side handles on all top and middle boxes are rubber coated, which gives a comfortable grip when the boxes need to be carried.
- All roller cabinets are equipped with rubberised transport handles so that it is easier to move them and the handles feature a soft comfortable grip.



TCW807N

- All drawers are equipped with three-step ball bearing slides so the drawers are easy to open and are also fully extendable, which gives easy access to the tools.
- The manufacturing method used means the top and middle boxes have a capacity of 20 kg and for the roller cabinets 25, 30, or 40 kilos.
- All drawers are fitted with foam inserts to minimise scratching, etc.
- All top boxes with the famous Teng Tools' eye logo, which makes the tool box more distinctive and striking.
- There is now a standard series, without extra equipment, but with the same high quality.

TC816SV 8 Series SV Stack

A professional quality 16 drawer stack system built up using the TC806SV 6 drawer top box, TC803SV middle box and TCW707EV 7 drawer roller cabinet.



TC816SV
TOOLS NOT INCLUDED

TC816STACK 8 Series Stack System

8 series tool box stack system using the TC806NF top box, TC803N middle box and TCW807N roller cabinet.



TC816STACK

TC819BK Personalised Black Stack System

8 series tool box stack system using the black 6 drawer top box, 3 drawer middle box and 10 drawer roller cabinet. The TC819BK stacks are available with the option of having a personalised top box at no extra cost.



FREE*

Personalisation & Branding Service

It is now possible to personalise your Teng Tools tool box using vinyl cut stickers. This can be in the format of an image or logo, or may just be your name. This is now available to you through your local stockist. Logos to be supplied as high resolution eps, crr, or ai vector format with cutting path if required

*Subject to artwork being supplied in the correct format.



Personalisation & Branding Service

Teng Tools have invested in their own Versacamm printing equipment enabling them to offer a complete personalisation and branding service for your tool box using vinyl cut transfers. Whether its a logo for your company or a picture of your favourite race team, this gives you the chance to have a toolbox that looks just the way you want it.

53" Wide Stack Systems

A choice of two configurations to make the ultimate stack system with a 53" wide roller cabinet and a 53" top box



TCW816LNSTACK

The TC810N 10 drawer 53" wide top box together with the TCW806LN 6 drawer 53" wide roller cabinet .

TCW819STACK

The TC810N 10 drawer 53" wide top box together with the TCW809N 9 drawer 53" wide roller cabinet.



TC103NF 2 Drawer Mini Top Box **NEW!**

- Drop front cover
- Ball bearing slides
- Supplied with rubber feet

Stock no	Dimension (mm)	Drawer Dimension (mm)	Weight (kilos)
TC103NF	275x150x146	215x130x38	2.9



TC805NFX 5 Drawer 8 series Deep Drawer Top Box with Ball Bearing Slides

Five full width 380mm deep drawers secured by a drop front cover with a combination lock, a plastic tote tray with an aluminium handle is also included. Heavy duty carrying handles on each side with rubber dipped grips for added comfort. Supplied with rubber feet and ideal for use on it's own or together with the Teng Tools TC tray or EVA tool control systems to build your own tool kit.

	Width (mm)	Depth (mm)	Height (mm)	Capacity (kilos)	Drawer thickness (mm)	Body frame thickness (mm)	Weight (kilos)
Overall	660	460	490		1	1	44
Drawer 1	578	380	46	25			
Drawer 2	578	380	46	25			
Drawer 3	578	380	75	25			
Drawer 4	578	380	75	25			
Drawer 5	578	380	75	25			



TC805SV 5 Drawer 8 Series Top Box with Ball Bearing Slides

Similar to TC805NFX but with key lock rather than combination lock, metal side handles rather than dipped handles and drawer fronts and no drawer mats or tote tray.

	Width (mm)	Depth (mm)	Height (mm)	Capacity (kilos)	Drawer thickness (mm)	Body frame thickness (mm)	Weight (kilos)
Overall	660	460	490		1	1	44
Drawer 1	578	380	46	25			
Drawer 2	578	380	46	25			
Drawer 3	578	380	75	25			
Drawer 4	578	380	75	25			
Drawer 5	578	380	75	25			



TC806NF 6 Drawer 8 Series Top Box with Ball Bearing Slides

Three full width drawers and three smaller drawers secured by a drop front cover with a combination lock, a plastic tote tray with an aluminium handle is also included. Heavy duty carrying handles on each side with rubber dipped grips for added comfort. Supplied with rubber feet and ideal for use on it's own or together with the Teng Tools TC tray or EVA tool control systems to build your own tool kit.

	Width (mm)	Depth (mm)	Height (mm)	Capacity (kilos)	Drawer thickness (mm)	Body frame thickness (mm)	Weight (kilos)
Overall	660	305	380		0.7	0.8	22
Drawer 1	172	270	50	20			
Drawer 2	172	270	50	20			
Drawer 3	172	270	50	20			
Drawer 4	572	270	50	20			
Drawer 5	572	270	50	20			
Drawer 6	572	270	75	20			



TC806SV 6 Drawer 8 Series Top Box with Ball Bearing Slides

Similar to TC806NF but with key lock rather than combination lock, metal side handles rather than dipped handles and no drawer mats or tote tray.

	Width (mm)	Depth (mm)	Height (mm)	Capacity (kilos)	Drawer thickness (mm)	Body frame thickness (mm)	Weight (kilos)
Overall	660	305	380		0.7	0.8	22
Drawer 1	172	270	50	20			
Drawer 2	172	270	50	20			
Drawer 3	172	270	50	20			
Drawer 4	572	270	50	20			
Drawer 5	572	270	50	20			
Drawer 6	572	270	75	20			



TC806NGM 6 Drawer personalised 8 series top box with ball bearing slides

Three full width drawers and three smaller drawers secured by a drop front cover with a combination lock, a plastic tote tray with an aluminium handle is also included. Heavy duty carrying handles on each side with rubber dipped grips for added comfort. Supplied with rubber feet and ideal for use on it's own or together with the Teng Tools TC tray or EVA tool control systems to build your own tool kit. Personalisation is provided at no extra cost subject to artwork being supplied in the correct format.

	Width (mm)	Depth (mm)	Height (mm)	Capacity (kilos)	Drawer thickness (mm)	Body frame thickness (mm)	Weight (kilos)
Overall	660	305	380		0.7	0.8	22
Drawer 1	172	270	50	20			
Drawer 2	172	270	50	20			
Drawer 3	172	270	50	20			
Drawer 4	572	270	50	20			
Drawer 5	572	270	50	20			
Drawer 6	572	270	75	20			



TC810N 53" wide 10 drawer 8 series Top box with ball bearing slides and rubber feet

Ten regular width drawers secured with a combination lock creating a 53" wide top box that can be used with either of the 53" wide roller cabinets (TCW806LN or TCW809N). Two heavy duty carrying handles on each side with rubber dipped grips for added comfort. Supplied with rubber feet and ideal for use on it's own or together with the Teng Tools TC tray or EVA tool control systems to build your own tool kit.

	Width (mm)	Depth (mm)	Height (mm)	Capacity (kilos)	Drawer thickness (mm)	Body frame thickness (mm)	Weight (kilos)
Overall	1337	455	560		0.7	0.8	101.5
Drawer 1	576	380	75	25			
Drawer 2	576	380	75	25			
Drawer 3	576	380	75	25			
Drawer 4	576	380	75	25			
Drawer 5	576	380	75	25			
Drawer 6	576	380	75	25			
Drawer 7	576	380	75	25			
Drawer 8	576	380	75	25			
Drawer 9	576	380	75	25			
Drawer 10	576	380	75	25			



TC803N 3 Drawer 8 Series Middle Box with Ball Bearing Slides

Three full width drawers secured with a combination lock, a middle box that can be used in combination with the regular sized top boxes and roller cabinets. Heavy duty carrying handles on each side with rubber dipped grips for added comfort. Supplied with rubber feet and ideal for use on it's own or together with the Teng Tools TC tray or EVA tool control systems to build your own tool kit.

	Width (mm)	Depth (mm)	Height (mm)	Capacity (kilos)	Drawer thickness (mm)	Body frame thickness (mm)	Weight (kilos)
Overall	660	305	250		0.7	0.8	13.8
Drawer 1	572	270	50	20			
Drawer 2	572	270	50	20			
Drawer 3	572	270	75	20			



TC803NBK Black 3 drawer middle box with ball bearing slides.

Three full width drawers secured with a combination lock, a middle box that can be used in combination with the regular sized top boxes and roller cabinets. Heavy duty carrying handles on each side with rubber dipped grips for added comfort. Supplied with rubber feet and ideal for use on it's own or together with the Teng Tools TC tray or EVA tool control systems to build your own tool kit. Personalisation is provided at no extra cost subject to artwork being supplied in the correct format.

	Width (mm)	Depth (mm)	Height (mm)	Capacity (kilos)	Drawer thickness (mm)	Body frame thickness (mm)	Weight (kilos)
Overall	660	305	250		0.7	0.8	13.8
Drawer 1	572	270	50	20			
Drawer 2	572	270	50	20			
Drawer 3	572	270	75	20			



TC803SV 3 Drawer 8 Series Middle Box with Ball Bearing Slides

Similar to TC803N but with key lock rather than combination lock, metal side handle rather than dipped handles and plain drawer fronts and no drawer mats.

	Width (mm)	Depth (mm)	Height (mm)	Capacity (kilos)	Drawer thickness (mm)	Body frame thickness (mm)	Weight (kilos)
Overall	660	305	250		0.7	0.8	13.8
Drawer 1	572	270	50	20			
Drawer 2	572	270	50	20			
Drawer 3	572	270	75	20			



TCW803N 3 Drawer 8 Series Roller Cabinet with Ball Bearing Slides and Lockable Cabinet

Three full width drawers and a lockable storage section secured with combination locks. Heavy duty side handle with rubber grip for added comfort and two fixed and two swivel 4" (100mm) castors with brakes for manoeuvrability. Supplied with an ABS top mat with storage compartments and a protective mat in each drawer. Ideal for use on it's own or together with the Teng Tools TC tray or EVA tool control systems to build your own tool kit.

	Width (mm)	Depth (mm)	Height (mm)	Overall height (mm)	Capacity (kilos)	Drawer thickness (mm)	Body frame thickness (mm)	Weight (kilos)
Overall	670	460	656	770		1.0	1.2/1.0	43.4
Drawer 1	575	380	75		25			
Drawer 2	575	380	75		25			
Drawer 3	575	380	150		30			
Base Storage	610	420	250					



TCW804N 4 drawer 8 series roller cabinet with ball bearing slides

Three regular full width drawers plus an extra deep drawer secured with a combination lock. Heavy duty side handle with rubber grip for added comfort and two fixed and two swivel 4" (100mm) castors with brakes for manoeuvrability. Supplied with an ABS top mat with storage compartments and a protective mat in each drawer. Ideal for use on it's own or together with the Teng Tools TC tray or EVA tool control systems to build your own tool kit.

	Width (mm)	Depth (mm)	Height (mm)	Overall height (mm)	Capacity (kilos)	Drawer thickness (mm)	Body frame thickness (mm)	Weight (kilos)
Overall	670	460	654	777		1.0	1.2/1.0	49.0
Drawer 1	575	380	75		25			
Drawer 2	575	380	75		25			
Drawer 3	575	380	75		25			
Drawer 4	575	380	312		25			



TCW806N 6 Drawer 8 Series Roller Cabinet with Ball Bearing Slides

Six regular full width drawers secured with a combination lock. Heavy duty side handle with rubber grip for added comfort and two fixed and two swivel 4" (100mm) castors with brakes for manoeuvrability. Supplied with an ABS top mat with storage compartments and a protective mat in each drawer. Ideal for use on it's own or together with the Teng Tools TC tray or EVA tool control systems to build your own tool kit.

	Width (mm)	Depth (mm)	Height (mm)	Overall height (mm)	Capacity (kilos)	Drawer thickness (mm)	Body frame thickness (mm)	Weight (kilos)
Overall	670	460	656	770		1.0	1.2/1.0	59
Drawer 1	575	380	75		25			
Drawer 2	575	380	75		25			
Drawer 3	575	380	75		25			
Drawer 4	575	380	75		25			
Drawer 5	575	380	75		25			
Drawer 6	575	380	150		30			



TCW806N1 6 Drawer 8 Series Roller Cabinet with Ball Bearing Slides and Combination Lock

Five regular full width drawers plus an extra deep drawer secured with a combination lock. Heavy duty side handle with rubber grip for added comfort and two fixed and two swivel 4" (100mm) castors with brakes for manoeuvrability. Supplied with an ABS top mat with storage compartments and a protective mat in each drawer. Ideal for use on it's own or together with the Teng Tools TC tray or EVA tool control systems to build your own tool kit.

	Width (mm)	Depth (mm)	Height (mm)	Overall height (mm)	Capacity (kilos)	Drawer thickness (mm)	Body frame thickness (mm)	Weight (kilos)
Overall	670	460	812	960		1.0	1.2/1.0	61.2
Drawer 1	575	380	75		25			
Drawer 2	575	380	75		25			
Drawer 3	575	380	75		25			
Drawer 4	575	380	75		25			
Drawer 5	575	380	75		25			
Drawer 6	575	380	312		25			



TCW907X 7 Drawer 9 Series Roller Cabinet with Soft Close Drawers and Ball Bearing Slides

A 9 series roller cabinet with seven soft close full width drawers each with an individual opening mechanism and all secured with a combination lock. Heavy duty side handle with rubber grip for added comfort and two fixed and two swivel 5" (125mm) castors with brakes for manoeuvrability. Supplied with an ABS top mat with storage compartments and a protective mat in each drawer. Ideal for use on it's own or together with the Teng Tools TC tray or EVA tool control systems to build your own tool kit.

	Width (mm)	Depth (mm)	Height (mm)	Overall height (mm)	Capacity (kilos)	Drawer thickness (mm)	Body frame thickness (mm)	Weight (kilos)
Overall	670	460	813	950		1.0	1.2/1.0	64
Drawer 1	575	380	75		25			
Drawer 2	575	380	75		25			
Drawer 3	575	380	75		25			
Drawer 4	575	380	75		25			
Drawer 5	575	380	75		25			
Drawer 6	575	380	150		30			
Drawer 7	575	380	150		30			



TCW807N 7 Drawer 8 Series Roller Cabinet with Ball Bearing Slides

Seven regular full width drawers all secured with a combination lock. Heavy duty side handle with rubber grip for added comfort and two fixed and two swivel 5" (125mm) castors with brakes for manoeuvrability. Supplied with an ABS top mat with storage compartments and a protective mat in each drawer. Ideal for use on it's own or together with the Teng Tools TC tray or EVA tool control systems to build your own tool kit.

	Width (mm)	Depth (mm)	Height (mm)	Overall height (mm)	Capacity (kilos)	Drawer thickness (mm)	Body frame thickness (mm)	Weight (kilos)
Overall	670	460	813	950		1.0	1.2/1.0	64
Drawer 1	575	380	75		25			
Drawer 2	575	380	75		25			
Drawer 3	575	380	75		25			
Drawer 4	575	380	75		25			
Drawer 5	575	380	75		25			
Drawer 6	575	380	150		30			
Drawer 7	575	380	150		30			



TCW707EV 7 Drawer 7 Series Roller Cabinet with Ball Bearing Slides

Similar to TCW807N but with key lock rather than combination lock, metal side handle rather than dipped handles and plain drawer fronts and no drawer mats.

	Width (mm)	Depth (mm)	Height (mm)	Overall height (mm)	Capacity (kilos)	Drawer thickness (mm)	Body frame thickness (mm)	Weight (kilos)
Overall	670	460	813	950		1.0	1.2/1.0	64
Drawer 1	575	380	75		25			
Drawer 2	575	380	75		25			
Drawer 3	575	380	75		25			
Drawer 4	575	380	75		25			
Drawer 5	575	380	75		25			
Drawer 6	575	380	150		30			
Drawer 7	575	380	150		30			



TCW808N 8 Drawer 8 Series Roller Cabinet with Ball Bearing Slides

Eight regular full width drawers all secured with a combination lock. Heavy duty side handle with rubber grip for added comfort and two fixed and two swivel 5" (125mm) castors with brakes for manoeuvrability. Supplied with an ABS top mat with storage compartments and a protective mat in each drawer. Ideal for use on it's own or together with the Teng Tools TC tray or EVA tool control systems to build your own tool kit.

	Width (mm)	Depth (mm)	Height (mm)	Overall height (mm)	Capacity (kilos)	Drawer thickness (mm)	Body frame thickness (mm)	Weight (kilos)
Overall	670	460	813	955		1.0	1.2/1.0	61
Drawer 1	576	380	75		25			
Drawer 2	576	380	75		25			
Drawer 3	576	380	75		25			
Drawer 4	576	380	75		25			
Drawer 5	576	380	75		25			
Drawer 6	576	380	75		25			
Drawer 7	576	380	75		25			
Drawer 8	576	380	154		25			



TCW810N 10 Drawer 8 Series Roller Cabinet with Ball Bearing Slides

Ten regular full width drawers all secured with a combination lock. Heavy duty side handle with rubber grip for added comfort and two fixed and two swivel 5" (125mm) castors with brakes for manoeuvrability. Supplied with an ABS top mat with storage compartments and a protective mat in each drawer. Ideal for use on it's own or together with the Teng Tools TC tray or EVA tool control systems to build your own tool kit.

	Width (mm)	Depth (mm)	Height (mm)	Overall height (mm)	Capacity (kilos)	Drawer thickness (mm)	Body frame thickness (mm)	Weight (kilos)
Overall	670	460	813	950		1.0	1.2/1.0	69
Drawer 1	575	380	50		25			
Drawer 2	575	380	50		25			
Drawer 3	575	380	50		25			
Drawer 4	575	380	50		25			
Drawer 5	575	380	50		25			
Drawer 6	575	380	50		25			
Drawer 7	575	380	75		25			
Drawer 8	575	380	75		25			
Drawer 9	575	380	75		25			
Drawer 10	575	380	150		30			



TCW810NBK Black 10 drawer roller cabinet with ball bearing slides

Ten regular full width drawers all secured with a combination lock. Heavy duty side handle with rubber grip for added comfort and two fixed and two swivel 5" (125mm) castors with brakes for manoeuvrability. Supplied with an ABS top mat with storage compartments and a protective mat in each drawer. Ideal for use on it's own or together with the Teng Tools TC tray or EVA tool control systems to build your own tool kit.

	Width (mm)	Depth (mm)	Height (mm)	Overall height (mm)	Capacity (kilos)	Drawer thickness (mm)	Body frame thickness (mm)	Weight (kilos)
Overall	670	460	813	950		1.0	1.2/1.0	69
Drawer 1	575	380	50		25			
Drawer 2	575	380	50		25			
Drawer 3	575	380	50		25			
Drawer 4	575	380	50		25			
Drawer 5	575	380	50		25			
Drawer 6	575	380	50		25			
Drawer 7	575	380	75		25			
Drawer 8	575	380	75		25			
Drawer 9	575	380	75		25			
Drawer 10	575	380	150		30			



TCW207N 37" 7 Drawer Roller Cabinet **NEW!**

A 37" wide roller cabinet designed to take the equivalent of 6 TC trays plus a TTX and a TTZ tool tray in each drawer. Seven 37" wide drawers each with a patented individual opening mechanism and all secured with a combination lock. Heavy duty side handle with rubber grip for added comfort and two fixed and two swivel 5" (125mm) castors with brakes for manoeuvrability. Supplied with a rubber top mat and a protective mat in each drawer. Ideal for use with the Teng Tools TC tray or EVA tool control systems to build your own tool kit. Also available as a complete work station with tools included – see the TCMM622N kit.

	Width (mm)	Depth (mm)	Height (mm)	Overall height (mm)	Capacity (kilos)
Overall	953	460	767	960	500
Drawer 1	860	380	812		
Drawer 2	860	380	75		
Drawer 3	860	380	75		
Drawer 4	860	380	75		
Drawer 5	860	380	75		
Drawer 6	860	380	150		
Drawer 7	860	380	150		



TCW806LN 53" 6 Drawer 8 Series Roller Cabinet with Ball Bearing Slides and a Wooden Top Plate.

Six 1.2 meter wide full width drawers with a patented one at a time opening mechanism and all secured with a combination lock. Heavy duty side handle with rubber grip for added comfort and four swivel 6" (150mm) castors (two with brakes) for extra manoeuvrability. Supplied with a wooden top plate and a protective mat in each drawer. Ideal for use on it's own or together with the Teng Tools TC tray or EVA tool control systems to build your own tool kit.



	Width	Depth	Height	Overall height	Capacity
	(mm)	(mm)	(mm)	(mm)	(kilos)
Overall	1350	460	767	937	
Drawer 1	1216	380	65		40
Drawer 2	1216	380	65		40
Drawer 3	1216	380	65		40
Drawer 4	1216	380	100		50
Drawer 5	1216	380	154		60
Drawer 6	1216	380	154		60

Drawer thickness (mm)	Body frame thickness (mm)	Weight (kilos)
1.0	1.2	121

TCW809N 53" 9 Drawer 8 Series Roller Cabinet with Ball Bearing Slides and a Wooden Top Plate.

Eight regular full width drawers together with one 1.2 meter wide full width drawer all secured with a combination lock. Heavy duty side handle with rubber grip for added comfort and four swivel 6" (150mm) castors (two with brakes) for extra manoeuvrability. Supplied with a wooden top plate and a protective mat in each drawer. Ideal for use on it's own or together with the Teng Tools TC tray or EVA tool control systems to build your own tool kit.



	Width	Depth	Height	Overall height	Capacity
	(mm)	(mm)	(mm)	(mm)	(kilos)
Overall	1350	460	767	937	
Drawer 1	1216	380	124		40
Drawer 2	575	380	75		25
Drawer 3	575	380	75		25
Drawer 4	575	380	75		25
Drawer 5	575	380	75		25
Drawer 6	575	380	75		25
Drawer 7	575	380	75		25
Drawer 8	575	380	150		25
Drawer 9	575	380	150		25

Drawer thickness (mm)	Body frame thickness (mm)	Weight (kilos)
1.0	1.2	136

TC-SC Service Case

Service case for use with up to 9 Teng Tools TC trays or six TC trays together with the SCPS01 service tools set. A robust moulded body with built in strength and durability, a telescopic aluminium handle, spring suspension and rubber wheels for a smooth ride, non slip rubber feet, with a combination lock and catches to keep the tools safe. Also available as a complete kit with different options to choose from. (527x385x197mm, 6.5 kilos)



TC-3 Carrying Case

Empty carrying case for use with 3 TC trays. Click lock and carrying handle. The underside of the case is fitted with rubber feet to prevent it from sliding. (470x320x65mm, 1.4 kilos)



Tools not included

TC-4 Carrying Case **NEW!**

- Empty carrying case for use with 4 TC trays
- Click lock and carrying handle
- Use with optional shoulder straps as a back pack (included)

Stock no	Description	Inner Dimension	Weight mm
TC-4	TC-4	685x105x66	1600
TC-4SBL	straps for TC-4		



Tools not included

TCSB Back Pack for Tools

A back pack specifically designed for carrying tools either with the shoulder straps as a back pack or with carrying handles for carrying in the hand. Manufactured in polyester with an EVA plastic base, external pockets for small tools and a large compartment for larger tools. (430x380x230mm, 1.29 kilos).



TCSB16 Carrying Bag for Tools

A carrying bag especially designed for carrying tools either with the metal carrying handle or the adjustable shoulder strap. A pocket on the outside and a holder on the inside for smaller tools. (410x280x300mm, 2.9 kilos).



TCP445C Carrying Box for Tools

A plastic carrying case, ideal for storing and carrying tools. Includes a tray with dividers and two snap locks. (445x240x202mm, 2.3 kilos)



TC540 5 drawer cantilever tool box

A professional quality cantilever style tool box with 5 individual compartments with padlock facility, full length piano hinges and turned edges for added safety. (530 x 220 x 350mm, 7.3 kilos)

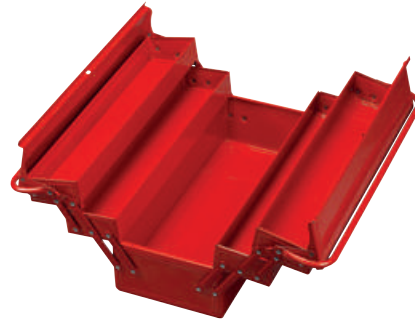

TC-540W Wheels for cantilever tool box

A set of four plastic swivel castors for using under the TC540 cantilever tool box.



TC450 Barn style tool box

Lockable barn style tool box supplied complete with base mat, tote tray, rubber feet, 3 removable aluminium clip rails, 30 1/4" drive socket clips, 30 3/8" drive socket clips and 30 1/2" drive socket clips. Also available as a complete kit (stock number TC187) including 1/4", 3/8" and 1/2" drive sockets and accessories together with combination spanners, pliers and screwdrivers. (450x200x200mm (closed), 5.5 kilos).



TCA05 Plastic Tote Tray

Designed for use in Teng Tools top boxes. Lightweight tote tray for carrying tools away from the tool box. Manufactured in plastic with an aluminum carrying handle, rubber mat and rubber feet to prevent sliding and scratching. (202x476x80mm, 0.5 kilos)

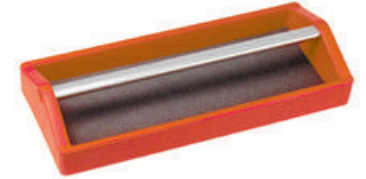

ABS-TOP ABS Top for Roller Cabinets

ABS tray designed to fit the top work surface of any Teng Tools roller cabinet. Individual parts areas plus positioning for a middle box or top box give a very organised work area and the ABS material protects the top of the roller cabinet from light scratches.



ALU450 Clip Rail

Aluminium sections for mounting on the wall or in a tool box for use with clips for 1/4", 3/8" or 1/2" sockets. 33 piece 450mm four track clip rail tray complete with carrying handle and 10 each of the 1/4", 3/8" and 1/2" drive socket clips



Aluminium sections for mounting on the wall or in a tool box for use with separate clips 1/4", 3/4", 3/8", 1/2" and 3/4" sockets.

Stock No	Description
ALU430	430mm single track socket rail
ALU1000-1	1 metre single track socket rail
ALU1000-4	1 metre four track socket rail

Aluminium Sections →

Separate Socket Clips.

Stock no.	Description
ALU14	10 x 1/4" drive socket clips
ALU38	10 x 3/8" drive socket clips
ALU12	10 x 1/2" drive socket clips
ALU34	10 x 3/4" drive socket clips



Tool Storage

TC-MAG Magnetic Tool Rail

6 individual magnets each with a capacity of 450 grams combined in a rail especially designed for fixing to Teng Tools roller cabinets, also suitable for wall mounting or other tool boxes. Ideal for hanging up tools while working. (457x52x17mm, 0.6 kilos)



TCDIVS 4 Piece Divider Set for Top and Middle Box Drawers

4 piece black divider set for top and middle box drawers. Sizes: 570x40x3mm 2 pieces, 272x40x3mm 2 pieces.



TCDIVL 4 Piece Divider Set for Roller Cabinet Drawers

4 piece black divider set for roller cabinet drawers (also fits TC805NFX deep drawer top box). Sizes: 570x40x3mm 2 pieces, 375x40x3mm 2 pieces.



TC-MAT Non Slip Tool Mat

Rubber mat for placing in tool boxes, on a roller cabinet, a work top or in tool box drawers, etc. Resistant to oil and grease. Cut to required format. Supplied in 2 meter rolls measuring 45cm and 2mm thick.



TCF01 Brackets for Middle Boxes

This set of brackets is used to secure a middle box to a roller cabinet and prevent it from tipping when moving from one location to another.



TCF02 Brackets for Top Boxes

This set of brackets is used to secure a top box to a roller cabinet and prevent it from tipping when moving from one location to another.



Tool Storage

TCW-D3 Add on cantilever drawer section

A set of three drawers in a cantilever type box for fixing to the side of any Teng Tools roller cabinet. Two drawers measure 460x90x50mm with a third deeper drawer measuring 460x90x110mm. (External dimensions 515(W)x350(H)x142(D)mm, 5.8 kilos). If mounted on a roller cabinet with a back panel fitted it is necessary to use the TCW-SP01 side plate to fix side accessories such as this set of drawers.

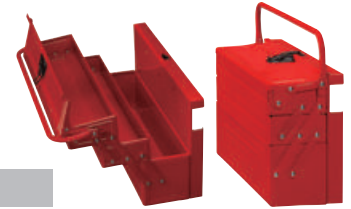

TCW-CAB Side Cupboard

A lockable side cabinet with fixing points for fitting to the side of Teng Tools roller cabinets (fittings included). Ideal for storing aerosols, and bulkier items. Fitted shelf included. External dimensions 400 (W) x 200 (D) x 500mm (H)



TCW-CAB01 7 Drawer Side Cabinet

A lockable 7 drawer side cabinet for adding to the side of any Teng Tools roller cabinet. Ideal for adding extra secure storage with the drawers lockable with a combination lock. If mounted on a roller cabinet with a back panel fitted it is necessary to use the TCW-SP01 side plate to fix side accessories such as this cabinet. External dimensions 382mm (W) x 795mm (H) x 460mm (D), overall weight 40.5 kilos.

	Width (mm)	Depth (mm)	Height (mm)	Capacity (kilos)
Overall	382	460	795	
Drawer 1	288	380	75	20
Drawer 2	288	380	75	20
Drawer 3	288	380	75	20
Drawer 4	288	380	75	20
Drawer 5	288	380	75	20
Drawer 6	288	380	150	20
Drawer 7	288	380	150	20



TCW-CAB02 Side Cabinet

A lockable side cabinet for adding to the side of any Teng Tools roller cabinet. Ideal for adding extra secure storage with the sliding drawer lockable with a combination lock. If mounted on a roller cabinet with a back panel fitted it is necessary to use the TCW-SP01 side plate to fix side accessories such as this cabinet. External dimensions 382mm (W) x 795mm (H) x 460mm (D), overall weight 33 kilos.



TCW-CAB03 Side Cabinet

A lockable side cabinet for adding to the side of any Teng Tools roller cabinet. Ideal for adding extra secure storage with two shelves and the door lockable with a combination lock. If mounted on a roller cabinet with a back panel fitted it is necessary to use the TCW-SP01 side plate to fix side accessories such as this cabinet. External dimensions 382mm (W) x 795mm (H) x 460mm (D), overall weight 22.5 kilos.



TCW-CAB04 Shelving unit

A shelving unit for adding to the side of any Teng Tools roller cabinet. Ideal for adding easy access storage with three open shelves. If mounted on a roller cabinet with a back panel fitted it is necessary to use the TCW-SP01 side plate to fix side accessories such as this cabinet. (795(H)x382(W)x460(D), 10.5 kilos.



TCTMC Top Box Trolley

The ideal way to move a regular size Teng Tools top box or middle box around with two fixed and two swivel castors with brakes. (3.5 kilos)



TCSMC Side Cabinet Trolley

Ideal for converting the Teng Tools 382x460mm side cabinets in to a free standing cabinet with two fixed and two swivel castors with brakes. (3.4 kilos)



Side Shelves for Roller Cabinets

Shelves that can be easily fixed to any flat ferrous metal surface using powerful magnets, ideal for using on the side of a Teng Tools roller cabinet.

Stock No.	Width (mm)	Depth (mm)	Height (mm)
580C	310	115	31
580D	210	115	31



Side Trays for Roller Cabinets

Trays that can be easily fixed to any flat ferrous metal surface using powerful magnets, ideal for using on the side of a Teng Tools roller cabinet.

Stock No.	Width (mm)	Depth (mm)	Height (mm)	No of magnets	Weight g
580K	230	98	136	2	625
580M	460	98	136	4	1,194



Can and Bottle Storage Trays for Roller Cabinets

Trays that can be easily fixed to any flat ferrous metal surface using powerful magnets, ideal for using on the side of a Teng Tools roller cabinet to store bottles, aerosol cans, etc.

Stock No.	Width (mm)	Depth (mm)	Height (mm)	No of magnets	Weight g
580CK	230	98	136	2	625
580CM	460	98	136	4	1,194
580CN	640	98	136	6	1,232



Magnetic Plastic Bowls

Plastic trays that can be easily fixed to any flat ferrous metal surface using powerful magnets, ideal for using on the side of a Teng Tools roller cabinet to store small components, etc.

Stock No.	Diameter (mm)	Weight g
580Q	112	191
580R	150	400



Side Trays for Roller Cabinets

A handy tray that can be easily fixed to any flat ferrous metal surface using a powerful magnetic strip, ideal for using on the side of a Teng Tools roller cabinet.

Stock No.	Width (mm)	Depth (mm)	Height (mm)
580J	410	90	100



TCNBC Set of 5" Roller Cabinet Castors

A set of four 5" (125mm) black castors with needle bearings and fixing plate. 2" (50mm) wide wheels give additional stability and strength with a capacity of 170 kilos per castor or 500 kilos for the set of four. Two fixed wheels and two swivel with two stage brakes. Suitable for use with Teng Tools roller cabinets.



TCW-SW Pair of 4" Roller Cabinet Castors

A pair of 4" (100mm) swivel castors with fixing plates to suit any Teng Tools roller cabinets. Particularly useful for replacing fixed wheels when the roller cabinet needs to be manoeuvred in and out of confined spaces such as under a work bench. Maximum load per castor 80 kilos.



Wooden plates for Roller Cabinets

37mm thick work tops in laminated wood for converting roller cabinets for use as a work bench. Three sizes available to suit different roller cabinets.

Stock No.	Length (mm)	Depth (mm)	Thickness (mm)	Suitable for
TC-TB02	672	460	37	TCW803N, TCW804N, TCW806N, TCW806N1, TCW807N, TCW808N, TCW810N, TCW707EV, TCW907X.
TC-TB03	948	155	18	TCW207N
TC-TB01	1,354	462	37	TCW806LN, TCW809N



TCDSH Pair of Handles for Top Boxes and Middle Boxes

A pair of side handles with soft grip for use with Teng Tools top boxes and middle boxes.



TCRFH Soft Grip Handle for Roller Cabinets

A replacement side handle for Teng Tools roller cabinets. The soft grip handle gives improved comfort.



TC-COVER Top Box Cover

Tool box cover for Teng Tools 3, 4 and 6 drawer top boxes.



TC-COVER1 Tool Box Cover

Tool box cover for tool kits and stack systems using the Teng Tools top box, middle box and 7, 8 or 10 drawer roller cabinets.



TC-WC02 Roller Cabinet Cover

Tool box cover for the Teng Tools standard width/height roller cabinets



ST-TTP01 Drawer labels

A set of 156 different images of the Teng Tools TC, TTD, TTPS, TTX and EVA tray ranges. Each individually cut out and with a high quality adhesive backing for sticking to tool box drawers.

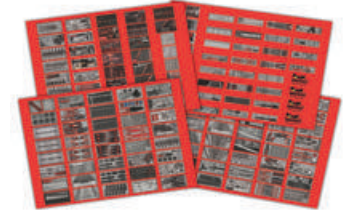

TCA02 Side Shelf for Roller Cabinets

A 300mm wide shelf for adding to the side of a Teng Tools roller cabinet. (455x300mm, 3.0 kilos)



TCA01 Sidetable, Paper Roll Holder

Side Table and Paper holder. Made to fit on the side of all Teng Tools Roller Cabinets (paper not included). Size 370x370mm, maximum width of paper roll 360mm.



TC-LOCK3 Three Lock Set

A set of three locks with one set of keys, ideal for EV type Mega Master tool kits or TC816SV stack systems for owners who want one key to fit all boxes.



TC-LOCK5 Five Lock Set

A set of five locks with one set of keys, ideal for stack system owners who want one key to fit all boxes. Includes 3 regular locks and 2 locks with bar fittings together with one pair of keys which allows conversion of all standard stack systems. Full details of which lock type fit which tool box or cabinet are shown below.



Locks for Tool boxes

3 different type locks for different tool boxes and cabinets. Please see table below for more information.



Stock No.
TCDRK
TCPRK
TCWPRK

Locks for Tool Boxes →

TC-BKEY Replacement Key Blanks

A pack of three blank keys for local cutting as spare keys for Teng Tools tool boxes with key locks.



Combination Locks for Tool Boxes

In 2009 Teng Tools changed the design of the 8 series tool boxes to incorporate combination locks rather key locks. These locks are also available as spare parts but cannot be retro fitted to replace key locks as the fixing position and mechanism is different. The table below shows which replacement lock is required for each of the 8 series tool boxes and roller cabinets.

Stock No.
TC-90CLOCK
TC-180CLOCK

Combination Locks for Tool Boxes →



Which Combination Lock?

Tool box	Description	Regular lock	Bar type lock
TC805NFX	5 drawer top box	TC-90CLOCK	
TC806NF	6 drawer top box	TC-90CLOCK	
TC806NGM	6 drawer top box	TC-90CLOCK	
TC803N	3 drawer middle box		TC-180CLOCK
TC803NBK	3 drawer middle box		TC-180CLOCK
TCW803N	3 drawer roller cabinet		TC-180CLOCK
TCW803N	cupboard	TC-90CLOCK	
TCW804N	4 drawer roller cabinet		TC-180CLOCK
TCW806N	6 drawer roller cabinet		TC-180CLOCK
TCW806N1	6 drawer roller cabinet		TC-180CLOCK
TCW807N	7 drawer roller cabinet		TC-180CLOCK
TCW810N	10 drawer roller cabinet		TC-180CLOCK
TCW810NBK	10 drawer roller cabinet		TC-180CLOCK
TC810N	10 drawer double width top box	TC-90CLOCK	
TCW207N	7 drawer 37" wide roller cabinet		TC-180CLOCK
TCW806LN	6 drawer double width roller cabinet		TC-180CLOCK
TCW809N	9 drawer double width roller cabinet		TC-180CLOCK

Which Combination Lock? - Continued

Tool box	Description	Regular lock	Bar type lock
TCW-CAB01	Side cabinet		TC-180CLOCK
TCW-CAB02	Side cabinet		TC-180CLOCK
TCW-CAB03	Side cabinet	TC-90CLOCK	

Which Key Type Lock?

Tool box	Description	Regular lock	Bar type lock
TC806SV	6 drawer top box	TCPRK	
TC803SV	3 drawer middle box		TCDRK
TCW707EV	7 drawer roller cabinet		TCDRK
TCW-CAB	Side cupboard	TCPRK	

Note: It is not possible to interchange key locks and combination locks. The locks are only available as replacements for existing locks.

TCW-SP Roller Cabinet Side Plate

Specially produced roller cabinet side plate measuring 460x640mm to suit Teng Tools roller cabinets. A support leg and carrying handle are built in enabling the Side Plate to be used as a portable or stand alone tool rack. (fully patent and design protected).

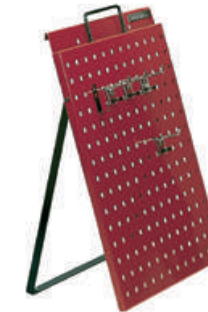

TCW-SP01 Roller Cabinet Side Plate

A side plate that need to be used on the side of Teng Tools roller cabinets if a back panel is used and hooks and hook on accessories or add on units such as side cabinets are to be added to the side of the roller cabinet. (805(H)x4560(W)x25(D))mm, 6.5 kilos).



Hooks for Teng Tools Side plates and tool panels

Stock no.	Description
TCW-HK10	7 x 90°, 3 x 45° hooks
TCW-HK02	10 double hooks
TCW-HK20	4 x 45° single, 4 x 45° double hooks, 4 x 90° single, 4 small and 4 large spring clips
TCW-HK45	10 45° hooks for TCW-SP side plate
TCW-HK90	10 90° hooks for TCW-SP side plate
TCW-HKAIR	10 air tool hooks for TCW-SP side plate
TCW-HKB	10 large spring clip hooks



DO'S AND DONT'S OF TOOL STORAGE

- ✓ **Keep it covered**
Use the Teng Tools tool box covers or another suitable cover to protect the tool boxes when they are not being used.
- ✓ **Make it secure**
If you are building a stack system use the Teng Tools TCF01 and TCF02 fixing brackets and fixings provided to secure each component to the stack
- ✓ **Water and chemical damage**
If any liquid spills on to the paint surface inside or outside the tool box clean it off immediately to protect the paint surface
- ✓ **Watch your weight**
Spread the weight of tools between the drawers and put the heavier tools in the lower drawers
- ✓ **Regular maintenance**
The drawer runners, ball bearing slides, hinges, locks, etc should all be lubricated with a light oil on a regular basis
- ✓ **Repair or replace any damaged parts**
All moving parts are subject to wear and should be replaced when worn – Teng Tools offer a full spare parts programme, full details are available from your local Teng Tools stockist
- ✗ **Don't overload your tool box**
Never overfill drawers or put too much weight in one drawer
- ✗ **Do not lift more than you should**
Follow established rules and guidelines – if it is more than 25 kilos you should not lift it on your own
- ✗ **Don't climb on the tool boxes**
Tool boxes are for storing tools do not use them as a ladder
- ✗ **One drawer at a time**
Be aware of the balance of your tool box, opening more than one drawer at a time can cause it to tip over
- ✗ **Do not shake the tool boxes about**
If the tool box has to be transported in a vehicle it should be fixed down firmly as the drawers, wheels and welding points can all be damaged by being bounced round
- When wheeling over an uneven surface be careful as this can also lead to damage particularly if the tool box is heavily loaded.



STORAGE

TC-3 case

Practical case measuring 470x320x65 mm. Holds 3 TT sets and is simple to carry.



Service case

Tool case with castors and telescopic handle. Holds a full 9 TT sets and is equipped with soft castors and a telescopic handle.



Top boxes

The range includes 8 different types of top boxes. Use it separately or on the top of your roller cabinet. Holds 12 TT sets and other special tools.



Middle boxes

The middle boxes are ideal on the roller cabinet and with a top box above. Or why not as separate tool storage. Holds 12 TT sets.



Roller cabinet

The range includes 9 different roller cabinets in two different heights and with a different number of drawers. The smaller models can hold 15 TT sets and in the largest a full 50 TT sets.

Double roller cabinet

The range includes 2 different cabinet widths to choose from. They are supplied with a hard-wearing worktop and hold up to 48 TT sets.



TOOL SETS

TT set

Tool set with removable cover. There are more than 92 different TT sets to choose from in the range. Can be used as a separate tool set or as a part of the concept. 142x265 mm.



TTD set

Tool set with removable cover, double the width of a TT set. 12 different sets to choose from. Can be used as a separate tool set or as a part of the concept. 285x265 mm.



TTZ set

The size of the 2 new trays is exactly half that of a TTX tray. 285 x 110 mm.



TTX set

As wide as the drawer in a roller cabinet. 30 in the range. 570x115 mm.



TTPS set

As large as the drawer in a top boxes. 5 in the range. 560x265 mm.



TTEVA set

Same size as the drawer in the roller cabinet. Manufactured of EVA foam in three different coloured layers and with recesses for tools. There are 19 different options to choose from. 560x375 mm.



TED

Tool sets with soft EVA foam inserts. With removable cover, can be used as a separate tool set or as a part of the concept. There are 19 options to choose from. 285x265 mm. There are also 14 TEX: TTX trays with soft EVA foam inserts. 570x115 mm



GET ORGANISED

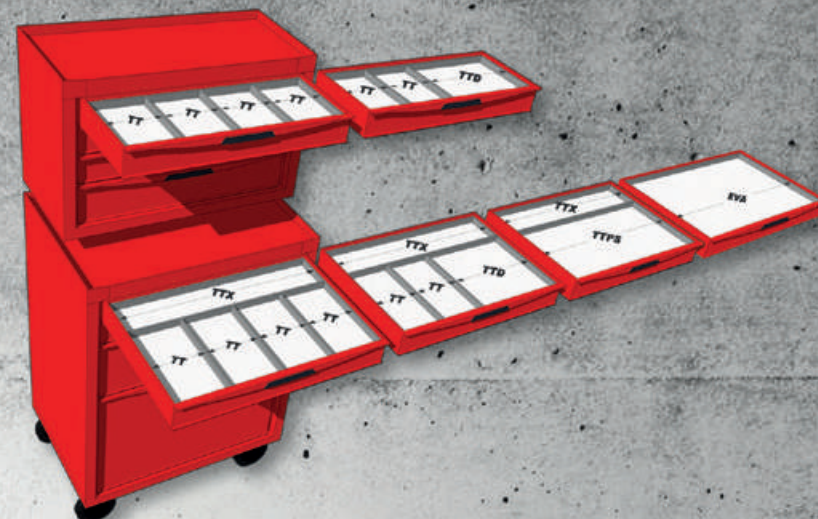

1. Choose the storage
2. Choose the tool sets
3. Snap together and place in the drawer

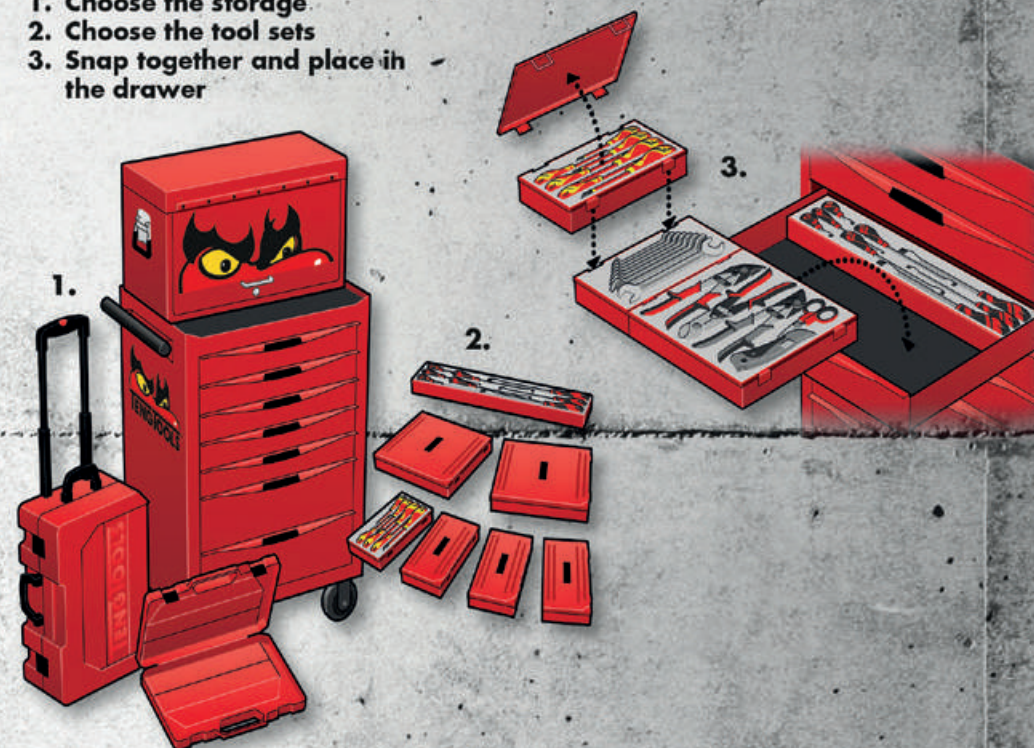

TTALU 32 piece clip rail set

Set consisting of two aluminium sections on which socket clips can be attached. Supplied in the unique Teng Tools TC tray with removable lid and dove tail joints for use on it's own or as part of the Teng Tools TC control system. The bottom of the case is covered with a protective mat. (265x142x50mm, 0.65 kilos)

Accessories 2 x 260mm aluminium rails, 10 x 1/4" drive socket clips, 10 x 3/8" drive socket clips, 10 x 1/2" drive socket clips



TT00 Storage Tray

Plastic TC tray with removable lid. Protective mat in the bottom. Supplied in the unique Teng Tools TC tray with removable lid and dove tail joints for use on it's own or as part of the Teng Tools TC control system. Also contains a holder for screwdrivers and spanners. (265x142x50mm, 0.24 kilos)

Supplied with removable clip holders for spanners and screwdrivers



TT01 Storage Tray

Storage tool tray with 7 separate compartments for easy storage. Supplied in the unique Teng Tools TC tray with removable lid and dove tail joints for use on it's own or as part of the Teng Tools TC control system. (265x142x50mm, 0.24 kilos)

Supplied with PS tray with 7 separate compartments



TT02 Storage Tray

Storage tray with removable lid. 2 separate compartments for easy storage. Supplied in the unique Teng Tools TC tray with removable lid and dove tail joints for use on it's own or as part of the Teng Tools TC control system. (265x142x50mm, 0.24 kilos)

Supplied with PS tray with 2 separate compartments



TT03 Storage Tray

Storage tray with removable lid. 4 separate compartments for easy storage. Supplied in the unique Teng Tools TC tray with removable lid and dove tail joints for use on it's own or as part of the Teng Tools TC control system. (265x142x50mm, 0.24 kilos)

Supplied with PS tray with 4 separate compartments



TT04 Storage Tray

Storage tray with removable lid. 6 separate compartments for easy storage. Supplied in the unique Teng Tools TC tray with removable lid and dove tail joints for use on it's own or as part of the Teng Tools TC control system. (265x142x50mm, 0.24 kilos)

Supplied with PS tray with 6 separate compartments



TTD00 Storage Tray

Double TC size storage tray with removable lid. 4 compartments for easy storage. Supplied in the unique Teng Tools TC tray with removable lid and dove tail joints for use on it's own or as part of the Teng Tools TC control system. (264x284x50mm, 0.6 kilos)

Supplied with PS tray with 4 separate compartments



TTD01 Storage Tray

Double TC tray size storage tray with removable lid. 8 compartments for easy storage. Supplied in the unique Teng Tools TC tray with removable lid and dove tail joints for use on it's own or as part of the Teng Tools TC control system. (264x284x50mm, 0.6 kilos)

Supplied with PS tray with 8 separate compartments



TTD02 Storage Tray

Double size storage tray with removable lid. 16 compartments for easy storage. Supplied in the unique Teng Tools TC tray with removable lid and dove tail joints for use on it's own or as part of the Teng Tools TC control system. (264x284x50mm, 0.6 kilos)

Supplied with PS tray with 16 separate compartments



TTX00 Storage Tray

TTX storage tray. Protective mat in the bottom. Supplied in the unique Teng Tools TTX tray for use on it's own or as part of the Teng Tools TC control system. (570x115x40mm, 0.3 kilos)

For use as a general storage tray



TTX01 Storage Tray

Storage tray with separate compartments for easy storage. Supplied in the unique Teng Tools TC tray for use on it's own or as part of the Teng Tools TC control system. (570x115x40mm, 0.4 kilos)

Supplied with PS tray with 6 separate compartments



TTX02 Storage Tray

Storage tray with removable lid. 4 separate compartments for easy storage. Supplied in the unique Teng Tools TC tray for use on it's own or part of the Teng Tools TC control system. (570x115x40mm,- 0.4 kilos)

Supplied with PS tray with 4 separate compartments



TTX03 Storage Tray

Storage tray with removable lid. 8 separate compartments for easy storage. Supplied in the unique Teng Tools TC tray for use on it's own or part of the Teng Tools TC control system. (570x115x40mm, 0.4 kilos)

Supplied with PS tray with 8 separate compartments



TTZ01 Storage Tray **NEW!**

A storage tray half the size of a TTX tray with six individual compartments for easy storage. Can be used on it's own or as part of the Teng Tools TC control system. (285x115x40mm, 0.23 kilos)



TT1435 1/4" drive socket set

Set containing 11 regular 6 point sockets, 6 deep 6 point sockets, 11 screwdriver bits, ratchet handle, universal joint, 2" and 4" extension bars, 1/4" coupler adaptor, 3/8"-1/4" adaptor and 1/4" screwdriver handle. Supplied in the unique Teng Tools TC tray with dove tail joints for use on it's own or as part of the Teng Tools TC control system. (265x142x50mm, 1.0 kilos)

Accessories	1/4" drive	Ratchet, universal joint, 2" and 4" extensions, coupler adaptor, 3/8" F:1/4"M T bar adaptor, 6" spinner handle
Regular sockets	1/4" drive 6 point	4, 5, 5.5, 6, 7, 8, 9, 10, 11, 12, 13mm
Deep sockets	1/4" drive 6 point	6, 7, 8, 10, 12, 13mm
Bits	1/4" hex	TPX10, 15, 20, 5mm, 6 mm hex, PH1, PH2, PZ1, PZ2, 4 mm, 5.5 mm flat



TT3819 3/8" drive socket set

Set containing 13 regular 6 point sockets, ratchet handle, universal joint, 3" wobble extension bar, 10" spinner handle with 3/8" drive at both ends, 1/2"-3/8" adaptor and 1/4" coupler adaptor. Supplied in the unique Teng Tools TC tray with removable lid and dove tail joints for use on it's own or as part of the Teng Tools TC control system. (265x142x50mm, 1.0 kilos)

Accessories	3/8" drive	Ratchet, universal joint, 3" wobble extension, 10" rotating spinner handle, 1/2" F:3/8" M T bar adaptor, coupler adaptor
Regular sockets	3/8" drive 6 point	8, 9, 10, 11, 12, 13, 14, 15, 16, 17, 18, 19, 22mm



TT3816 3/8" drive deep sockets

Set containing 16 deep 6 point sockets 3/8" drive. Supplied in the unique Teng Tools TC tray with removable lid and dove tail joints for use on it's own or as part of the Teng Tools TC control system. (265x142x50mm, 1.5 kilos)

Deep sockets	3/8" drive 6 point	7, 8, 9, 10, 11, 12, 13, 14, 15, 16, 17, 18, 19, 20, 21, 22mm
--------------	--------------------	---



TTAF32 1/4" & 3/8" AF socket set

Set containing 1/4" and 3/8" drive 6 point sockets, regular and deep. Supplied in the unique Teng Tools TC tray with removable lid and dove tail joints for use on it's own or as part of the Teng Tools TC control system. (265x142x50mm, 1.36 kilos)

Regular sockets	1/4" drive 6 point	3/16" 7/32" 1/4" 9/32" 5/16" 11/32" 3/8" 7/16" 1/2"
Deep sockets	1/4" drive 6 point	3/16" 7/32" 1/4" 9/32" 5/16" 11/32" 3/8" 7/16" 1/2"
Regular sockets	3/8" drive 6 point	3/8" 7/16" 1/2" 9/16" 5/8" 11/16" 3/4"
Deep sockets	3/8" drive 6 point	3/8" 7/16" 1/2" 9/16" 5/8" 11/16" 3/4"



TTTX30 3/8" drive TX/TPX/TXE socket set

30 piece 3/8" drive bit socket set containing 28 TX, TPX and TX-E socket bits for internal and external heads plus 3/8" -1/4" adaptor, and 3" extension bar 3/8" drive. Supplied in the unique Teng Tools TC tray with removable lid and dove tail joints for use on it's own or as part of the Teng Tools TC control system. (265x142x50mm, 1.1 kilos)

Accessories	3/8" drive	3" extension, 3/8" F:1/4" M adaptor
TX bit sockets	3/8" drive	TX10, 15, 20, 25, 27, 30, 40, 45, 50
TPX bit sockets	3/8" drive	TPX10, 15, 20, 25, 27, 30, 40, 45, 50
TX-E sockets	1/4" drive	E4, E5, E6, E7, E8
	3/8" drive	E10, E12, E14, E16, E18



TTBS35 1/4" & 3/8" drive bit socket set

35 piece 1/4" and 3/8" drive set containing 33 bits for hex, TX, PH, PZ and flat type, plus 2 adaptors. Supplied in the unique Teng Tools TC tray with removable lid and dove tail joints for use on it's own or as part of the Teng Tools TC control system. (265x142x50mm, 1.25 kilos)

Bits sockets	1/4" drive	PH0, PH1, PH2, PH3, PZ1, PZ2, PZ3, 4mm flat, 4.5mm flat, 7mm flat, TX10, TX15, TX20, TX25, TX27, TX30, TX40
Hex bit sockets	3/8" drive metric	3, 4, 5, 5.5, 6, 7, 8, 10, 12mm
Hex bit sockets	3/8" drive AF	1/8" 5/32" 3/16" 7/32" 1/4" 5/16" 3/8"
Accessories		1/4" F:3/8" M adaptor, 3/8" F:1/4" M adaptor



TTXTB05 3/8" drive extra long swivel spark plug set

5 piece set with 3/8" drive extra long swivelling spark plug sockets and a T bar with handle. Supplied in the unique Teng Tools drawer width TTX tray for use on it's own or as part of the Teng Tools TC control system. (570x115x70mm, 6.5 kilos)

Spark plug sockets	14, 16, 21mm
Accessories	2 piece T bar handle



TTXTB09 3/8" drive extra long socket set

9 piece set with 3/8" drive sockets and a T bar with handle. Supplied in the unique Teng Tools drawer width TTX tray for use on it's own or as part of the Teng Tools TC control system. (570x115x70mm, 6.5 kilos)

Extra long sockets	8, 10, 12, 13, 14, 17, 19mm
Accessories	2 piece T bar handle



TT1205 1/2" drive ratchet & accessories

1/2" drive accessories set containing ratchet handle with quick release and twist reverse. Also includes universal joint and 5" and 10" extensions. Supplied in the unique Teng Tools TC tray with removable lid and dove tail joints for use on it's own or as part of the Teng Tools TC control system. (265x142x50mm, 1.1 kilos)

Accessories	1/2" drive Ratchet, universal joint, 5" and 10" extensions, 3/8" F:1/2" M T bar adaptor
-------------	---



TT1211 1/2" drive deep socket set

Set containing 10 12 point deep 1/2" drive sockets and 10" flex handle. Supplied in the unique Teng Tools TC tray with removable lid and dove tail joints for use on it's own or as part of the Teng Tools TC control system. (265x142x50mm, 2.0 kilos)

Accessories	1/2" drive	10" flex handle
Deep sockets	1/2" drive 12 point	10, 11, 12, 13, 14, 15, 16, 17, 18, 19mm



TT1217 1/2" drive socket set (12 point)

Socket set containing 12 point sockets. Supplied in the unique Teng Tools TC tray with removable lid and dove tail joints for use on it's own or as part of the Teng Tools TC control system. (265x142x50mm, 1.8 kilos)

Regular sockets 1/2" drive	12 point	10, 11, 12, 13, 14, 15, 16, 17, 18, 19, 20, 21, 22, 24, 27, 30, 32mm
----------------------------	----------	--



TT1217-6 1/2" drive socket set (6 point)

Socket set containing 6 point sockets. Supplied in the unique Teng Tools TC tray with removable lid and dove tail joints for use on it's own or as part of the Teng Tools TC control system. (265x142x50mm, 1.8 kilos)

Regular sockets 1/2" drive	6 point	10, 11, 12, 13, 14, 15, 16, 17, 18, 19, 20, 21, 22, 24, 27, 30, 32mm
----------------------------	---------	--



TT1218 1/2" drive socket set (12 point)

17 piece metric socket set containing 12 point sockets. Also contains ratchet handle with quick release and twist reverse, 2 1/2" and 6" extension bars, 3/8-1/2" adaptor as well as a universal joint. Supplied in the unique Teng Tools TC tray with removable lid and dove tail joints for use on it's own or as part of the Teng Tools TC control system. (265x142x50mm, 2.2 kilos)

Accessories	1/2" drive Ratchet, universal joint, 2 1/2" and 6" extensions, 3/8" F:1/2" M T bar adaptor
Regular sockets 1/2" drive	12 point 10, 11, 12, 13, 14, 15, 16, 17, 18, 19, 22, 24mm



TT1218-6 1/2" drive socket set (6 point)

17 piece metric socket set containing 6 point sockets. Also contains ratchet handle with quick release and twist reverse, 2 1/2" and 6" extension bars, 3/8-1/2" adaptor as well as a universal joint. Supplied in the unique Teng Tools TC tray with removable lid and dove tail joints for use on it's own or as part of the Teng Tools TC control system. (265x142x50mm, 2.2 kilos)

Accessories	1/2" drive Ratchet, universal joint, 2 1/2" and 6" extensions, 3/8" F:1/2" M T bar adaptor
Regular sockets 1/2" drive	6 point 10, 11, 12, 13, 14, 15, 16, 17, 18, 19, 22, 24mm



TT1215AF 1/2" Drive AF socket set

Socket set containing 15 regular AF 12 point sockets. Supplied in the unique Teng Tools TC tray with removable lid and dove tail joints for use on it's own or as part of the Teng Tools TC control system. (265x142x50mm, 1.7 kilos)

Regular sockets 1/2" drive	12 point	3/8" 7/16" 1/2" 9/16" 5/8" 11/16" 3/4" 13/16" 7/8" 15/16" 1" 1 1/4" 1 1/2" 1 3/4" 1 1/2"
----------------------------	----------	--



TTHEx16 1/2" drive hex bit socket set

Set containing 16 1/2" drive bit sockets for internal hex holes. Supplied in the unique Teng Tools TC tray with removable lid and dove tail joints for use on it's own or as part of the Teng Tools TC control system. (265x142x50mm, 1.5 kilos)

55mm hex bit sockets	5, 6, 7, 8, 9, 10, 12, 14, 17mm
100mm hex bit sockets	5, 6, 10, 12, 14, 17mm
115mm hex bit sockets	8mm



TTHEx23 1/2" drive hex bit socket set

Set containing 20 bits, regular and long, for internal hex holes. Also includes 2 adaptors and a 2mm hex mini screwdriver for tightening the retaining grub screw in the adaptors. Supplied in the unique Teng Tools TC tray with removable lid and dove tail joints for use on it's own or as part of the Teng Tools TC control system. (265x142x50mm, 1.1 kilos)

Adaptors	1/2" drive	10mm hex bit adaptor, 12mm hex bit adaptor
Hex bits 40mm	10mm hex drive	5, 6, 7, 8, 9, 10mm
Hex bits 40mm	12mm hex drive	12, 14, 17, 19mm
Hex bits 75mm	10mm hex drive	5, 6, 7, 8, 9, 10mm
Hex bits 75mm	12mm hex drive	12, 14, 17, 19mm
Accessories		2mm hex mini screwdriver



TTTX18 1/2" drive TX bit socket set

Set containing 18 1/2" drive bit sockets for internal TX holes. Supplied in the unique Teng Tools TC tray with removable lid and dove tail joints for use on it's own or as part of the Teng Tools TC control system. (265x142x50mm, 1.5 kilos)

55mm TX bit sockets	TX20, TX25, TX27, TX30, TX40, TX45, TX50, TX55, TX60
110mm TX bit sockets	TX20, TX25, TX27, TX30, TX40, TX45, TX50, TX55, TX60



TTTX23 1/2" drive TX bit socket set

Set containing 20 bits, regular and long for internal TX heads. Also includes 2 adaptors and a 2mm hex mini screwdriver for tightening the retaining grub screws in the adaptors. Supplied in the unique Teng Tools TC tray with removable lid and dove tail joints for use on it's own or as part of the Teng Tools TC control system. (265x142x50mm, 1.1 kilos)

Adaptors	1/2" drive	10mm hex adaptor 12mm hex adaptor
Hex bits 40mm	10mm drive 12mm drive	TX20, 25, 27, 30, 40, 45, 50, 55 TX60, 70
Hex bits 75mm	10mm drive 12mm drive	TX20, 25, 27, 30, 40, 45, 50, 55 TX60, 70
Accessories		2mm hex mini screwdriver



TTRS15 1/2" Ribe & XZN socket set

Set containing 15 1/2" drive Ribe and Spline bit sockets with a satin finish. Supplied in the unique Teng Tools TC tray with removable lid and dove tail joints for use on it's own or as part of the Teng Tools TC control system. (265x142x50mm, 1.66 kilos)

Ribe bit sockets	100mm	No. 4, 5, 6, 8, 10, 11, 12, 13
XZN bit sockets	100mm	No. 5, 6, 8, 10, 12, 14, 16



TTTXH15 1/2" drive hex & TX bit socket set

15 piece set containing 100mm long bit sockets. 9 pieces for internal TX heads and 6 pieces for internal hex holes. Supplied in the unique Teng Tools TC tray with removable lid and dove tail joints for use on it's own or as part of the Teng Tools TC control system. (265x142x50mm, 1.40 kilos)

TX bit sockets	1/2" drive	TX20, TX25, TX27, TX30, TX40, TX45, TX50, TX55, TX60
Hex bit sockets	1/2" drive	5mm, 6mm, 7mm, 8mm, 10mm, 12mm



TTXEXT13 Extension bar set

Set containing 6 extension bars (1/4", 3/8" and 1/2" drive), universal joints 1/4", 3/8" and 1/2", 3/8" - 1/4" adaptor, as well as a T handle and mini screwdrivers for tightening the retaining grub screws in the adaptors. The unique T handle can be used in conjunction with the extension bars to create a comfortable T handle grip for added torque and ease of use. Supplied in the unique Teng Tools TTX tray for use on it's own or as part of the Teng Tools TC control system. (570x115x40mm, 2.0 kilos)



Accessories	1/4" drive	6" and 12" extensions, universal joint
	3/8" drive	3" wobble extension, 20" extension, universal joint, 3/8"F:1/4"M T bar adaptor
Accessories	1/2" drive	3" wobble extension, 20" extension, universal joint
		T handle grip, 2.0mm hex and 2.5mm hex mini screwdrivers

TTX3404 3/4" ratchet & accessories

4 piece 3/4" drive set containing 72 teeth ratchet handle with quick release and twist reverse, two extension bars 200mm and 400mm as well as a sliding T bar. Supplied in the unique Teng Tools TTX tray for use on it's own or as part of the Teng Tools TC control system. (570x115x70mm, 6.1 kilos)



Accessories	3/4" drive	Quick release ratchet handle, 200 and 400mm extensions, sliding T bar
-------------	------------	---

TTX3404S 3/4" drive ratchet and accessories with safety locking mechanism

4 piece 3/4" drive set containing 72 teeth ratchet handle with quick release and twist reverse, two extension bars 200mm and 400mm as well as a sliding T bar. The accessories incorporate a safety locking mechanism to avoid tools being dropped. Supplied in the unique Teng Tools drawer width TTX tray for use on it's own or as part of the Teng Tools TC control system. (570x115x70mm, 6.5 kilos)



Accessories	3/4" drive	Quick release ratchet handle, 200 and 400mm extensions, sliding T bar
-------------	------------	---

TTX3414 3/4" drive socket set

14 piece set containing 6 point metric sockets. Chrome vanadium steel. Supplied in the unique Teng Tools TTX tray for use on it's own or as part of the Teng Tools TC control system. (570x115x74mm, 5.5 kilos)



Regular sockets	3/4" drive	6 point	19, 21, 22, 24, 27, 30, 32, 33, 34, 36, 38, 41, 46, 50mm
-----------------	------------	---------	--

TTX34AF 3/4" drive AF socket set

14 piece set containing 12 point AF sockets. Chrome vanadium steel. Supplied in the unique Teng Tools TTX tray for use on it's own or as part of the Teng Tools TC control system. (570x115x74mm, 5.5 kilos)



Regular sockets	3/4" drive	12 point	7/8" 15/16" 1" 1 1/8" 1 1/4" 1 1/2" 1 3/4" 1 7/8"
-----------------	------------	----------	---

TTADP17 Adaptor set

A set of 17 different adaptors for use with 1/4", 3/8", 1/2" and 3/4" drive sockets and accessories as well as 1/4" hex drive bits. Supplied in the unique Teng Tools TC tray with removable lid and dove tail joints for use on it's own or as part of the Teng Tools TC control system. (265x142x50mm, 1.3 kilos)

Step up adaptors	3/4"F:1"M, 1/2"F:3/4"M, 3/8"F:1/2"M, 1/4"F:3/8"M
Reducing adaptors	3/4"F:1/2"M, 1/2"F:3/8M, 3/8"F:1/4"M
Coupler bit adaptors	1/4" and 3/8" drive for 1/4" hexagon bits
Hexagon bit adaptors	1/4" and 3/8" drive male adaptors
50mm hex bit adaptors	1/4", 3/8" and 1/2" drive male adaptors
Magnetic bit holders	50 and 70mm length
Chuck bit holders	50mm length with quick release



TTDAWM13M 1/2" Drive Compact Impact Gun Set

A 13 piece impact gun set including a compact and lightweight 1/2" drive impact wrench for use in confined spaces together with stubby 1/2" drive impact sockets covering 10 to 24mm. Supplied in the unique Teng Tools double TC tray with removable lid and dove tail joints for use on its own or as part of the Teng Tools TC control system. (265x284x50mm, 3.2 kilos).



Accessories	1/2" drive compact air gun, maximum torque 770Nm
Stubby impact sockets	1/2" drive 10, 12, 13, 14, 15, 16, 17, 18, 19, 21, 22, 24mm

TT9207 1/2" drive impact accessories

1/2" drive impact socket accessory set containing extension bars, universal joint and adaptors. For use with retaining pins and rings. Supplied in the unique Teng Tools TC tray with removable lid and dove tail joints for use on it's own or as part of the Teng Tools TC control system. (265x142x50mm, 1.05 kilos)

Adaptors		3/8"Fx1/2"M, 1/2"Fx3/4"M, 1/2"Fx3/8"M
Extension Bars	1/2" drive	3", 5" and 10"
Universal Joint	1/2" drive	



TT9207A 1/2" drive impact accessories

1/2" drive impact socket accessory set containing extension bars, universal joint and adaptors. ANSI standard type impact accessories for automotive use. Supplied in the unique Teng Tools TC tray with removable lid and dove tail joints for use on it's own or as part of the Teng Tools TC control system. (265x142x50mm, 1.05 kilos)

Adaptors		3/8"Fx1/2"M, 1/2"Fx3/4"M, 1/2"Fx3/8"M
Extension Bars	1/2" drive	3", 5" and 10"
Universal Joint	1/2" drive	



TT9024 1/4" & 3/8" drive impact socket set

24 piece set containing 1/4" drive regular and 3/8" drive regular and deep impact sockets plus an adaptor. Supplied in the unique Teng Tools TC tray with removable lid and dove tail joints for use on it's own or as part of the Teng Tools TC control system. (265x142x50mm, 1.07 kilos)

Accessories	3/8" drive		3/8"Fx1/4"M adaptor
Regular impact sockets	1/4" drive	6 point	6, 7, 8, 10, 13mm
Regular impact sockets	3/8" drive	6 point	8, 10, 11, 12, 13, 14, 16, 17, 19mm
Deep impact sockets	3/8" drive	6 point	8, 10, 11, 12, 13, 14, 16, 17, 19mm



TT9116 1/2" drive impact socket set

Set containing 16 1/2" drive impact sockets, regular and deep. ANSI Standard suitable for automotive use. Supplied in the unique Teng Tools TC tray with removable lid and dove tail joints for use on it's own or as part of the Teng Tools TC control system. (265x142x50mm, 2.2 kilos)

Regular impact sockets	1/2" drive	6 point	13, 15, 16, 17, 18, 19, 22, 24mm
Deep impact sockets	1/2" drive	6 point	13, 15, 16, 17, 18, 19, 22, 24mm



TT9120D 1/2" drive impact socket set

Set containing 20 1/2" drive impact sockets, regular and deep plus locking pins and O-Rings. DIN Standard suitable for industrial use with retaining rings and pins. Supplied in the unique Teng Tools TC tray with removable lid and dove tail joints for use on it's own or as part of the Teng Tools TC control system. (265x142x50mm, 3.2 kilos)

Regular impact sockets	1/2" drive	6 point	13, 15, 16, 17, 18, 19, 22, 24mm
Deep impact sockets	1/2" drive	6 point	13, 15, 16, 17, 18, 19, 22, 24mm
Locking pins			20x3.5mm, 25x3.5mm
O-Rings			3x20mm, 3x24mm



TT9015HX 3/8" & 1/2" drive impact hex bit socket set

15 piece 3/8" and 1/2" drive hex impact socket bit set. Supplied in the unique Teng Tools TC tray with removable lid and dove tail joints for use on it's own or as part of the Teng Tools TC control system. (265x142x50mm, 1.49 kilos)

Hex impact socket bits	3/8" drive	4, 5, 6, 7, 8, 10, 12mm
Hex impact socket bits	1/2" drive	5, 6, 8, 10, 12, 14, 17mm



TT9212TX 1/2" drive impact TX bit socket set

Set containing 12 1/2" drive TX impact sockets. Suitable for use with retaining rings and pins. Supplied in the unique Teng Tools TC tray with removable lid and dove tail joints for use on it's own or as part of the Teng Tools TC control system. (265x142x50mm, 1.36 kilos)

TX impact sockets	1/2" drive	TX 10, 15, 20, 25, 27, 30, 40, 45, 50, 55, 60, 70
-------------------	------------	---



TTID20 1/2" drive impact driver set

Set containing 1/2" impact driver, coupler adaptor, 5/16"-3/8" hex adaptor as well as 17 bits. Supplied in the unique Teng Tools TC tray with removable lid and dove tail joints for use on it's own or as part of the Teng Tools TC control system. (265x142x50mm, 1.3 kilos)

Accessories	1/2" drive	reversible impact driver, coupler adaptor, 5/16" hex:3/8" M adaptor
36mm bits	5/16" drive	6mm flat, 8mm flat, 10mm flat, 12mm flat, PH1, PH2, PH3, PH4, 4mm hex, 5mm hex, 6mm hex, 8mm hex, TX30, TX40, TX45, TX50, TX55



TTD9416 3/4" drive impact socket set

3/4" drive impact socket set containing regular sockets 19 to 38mm, plus accessories including extension bar and retaining rings and pins. Supplied in the unique Teng Tools TC tray with removable lid and dove tail joints for use on it's own or as part of the Teng Tools TC control system. (265x284x50mm, 5.6kilos)

Accessories	3/4" drive	7" impact extension bar, 3 retaining rings, 3 retaining pins
Regular impact sockets	3/4" drive 6 point	19 (3/4"), 24, 27 (1 1/8"), 30 (1 1/4"), 32, 33, 34, 36, 38mm



TTX9415 3/4" drive impact socket set

15 piece set containing 15 metric regular and deep impact sockets to DIN standard. Suitable for use with retaining rings and pins. Supplied in the unique Teng Tools TTX tray for use on it's own or as part of the Teng Tools TC control system. (570x115x60mm, 9.0 kilos)



Regular impact sockets	3/4" drive 6 point	19, 24, 27, 28, 30, 32, 34, 36mm
Deep impact sockets	3/4" drive 6 point	19 (3/4"), 24, 27 (11/16"), 30 (13/16"), 32, 33, 36mm

TT8012 Anti slip Combination Spanner Set

12 piece metric combination spanner set featuring a typically Teng new design in combination spanners that gives an anti slip grip on the open end as well as the Teng Tools hip grip function where the spanner drives on the flank of the fastening rather than the corner, two design features that combine to give a much better grip with much less risk of damage to the fastening. The design also gives grip on fastenings with worn or rounded corners. Supplied in the unique Teng Tools TC tray with removable lid and dove tail joints for use on it's own or as part of the Teng Tools TC control system. (265x142x50mm, 1.2 kilos)

Combination spanners	8, 9, 10, 11, 12, 13, 14, 15, 16, 17, 18, 19mm
----------------------	--



TT6010M Stubby spanner set

Set of 10 stubby spanners made of chrome vanadium steel. Same dimension at both ends. The 12 point ring head is set at a 15° angle. Satin finish. Supplied in the unique Teng Tools TC tray with removable lid and dove tail joints for use on it's own or as part of the Teng Tools TC control system. (265x142x50mm, 1.0 kilos)

Midget combination spanners	10, 11, 12, 13, 14, 15, 16, 17, 18, 19mm
-----------------------------	--



TT1236 Metric combination spanner set

12 piece metric spanner set, chrome vanadium steel. Same dimension at both ends. The 12 point ring head is set at a 15° angle. Polished heads. Satin finish. Supplied in the unique Teng Tools TC tray with removable lid and dove tail joints for use on it's own or as part of the Teng Tools TC control system. (265x142x50mm, 1.7 kilos)

Combination spanners	8, 9, 10, 11, 12, 13, 14, 15, 16, 17, 18, 19mm
----------------------	--



TT3592 AF Combination spanner set

8 piece AF spanner set, chrome vanadium steel. Same dimension at both ends. The 12 point ring head is set at a 15° angle. Polished heads. Satin finish. Supplied in the unique Teng Tools TC tray with removable lid and dove tail joints for use on it's own or as part of the Teng Tools TC control system. (265x142x50mm, 1.0 kilos)

Combination spanners	5/16" 3/8" 7/16" 1/2" 9/16" 5/8" 11/16" 3/4"
----------------------	--



TTX2032 Metric combination spanner set

7 piece metric combination spanner set ranging from 20 to 32mm. Chrome vanadium steel. The 12 point ring head is angled at a 15° angle. Satin finish. Supplied in the unique Teng Tools TTX tray for use on it's own or as part of the Teng Tools TC control system. (570x115x60mm, 2.6 kilos)



Combination spanners	20, 21, 22, 24, 27, 30, 32mm
----------------------	------------------------------

TTX2640 AF combination spanner set

7 piece combination spanner set ranging from 13/16" to 1 1/4". Chrome vanadium steel. The 12 point ring head is angled at a 15° angle. Satin finish. Supplied in the unique Teng Tools TTX tray for use on it's own or as part of the Teng Tools TC control system. (570x115x72mm, 2.6 kilos)



Combination spanners	13/16" 7/8" 15/16" 1" 1 1/4" 1 1/2" 1 3/4"
----------------------	--

TTXLMP12 Extra Long Combination Spanner Set

12 piece extra long combination spanner set ranging from 8 to 19mm. Chrome vanadium, satin finish. Supplied in the unique Teng Tools drawer width TTX tray for use on it's own or as part of the Teng Tools TC control system. (570x115x70mm, 6.5 kilos)



Combination spanners	8, 9, 10, 11, 12, 13, 14, 15, 16, 17, 18, 19mm
----------------------	--

TT6508R Ratcheting combination spanner set

8 piece ratcheting combination spanner set. Combined ring/open ended spanners with 12 point ring. Ratchet with flip reverse and offset by 13° for use on flat surfaces. Same size at both ends. Chrome vanadium. Satin finish. Supplied in the unique Teng Tools TC tray with removable lid and dove tail joints for use on it's own or as part of the Teng Tools TC control system. (265x142x50mm, 1.0 kilos)

Ratchet spanners 8, 10, 11, 12, 13, 14, 17, 19mm



TT6511R Ratcheting combination spanner set

11 piece ratcheting combination spanner set. Combined ring/open ended spanners with 12 point ring. Ratchet with flip reverse and offset by 13° for use on flat surfaces. Same size at both ends. Chrome vanadium. Satin finish. Supplied in the unique Teng Tools TC tray with removable lid and dove tail joints for use on it's own or as part of the Teng Tools TC control system. (265x142x50mm, 1.34 kilos)

Ratchet spanners 8, 10, 11, 12, 13, 14, 15, 16, 17, 18, 19mm



TT6508RAF AF Ratcheting spanner set

8 piece ratcheting AF combination spanner set. Combined ring/open ended spanners with 12 point ring ratchet with flip reverse and offset by 13° for use on flat surfaces. Same size at both ends. Chrome vanadium. Satin finish. Supplied in the unique Teng Tools TC tray with removable lid and dove tail joints for use on it's own or as part of the Teng Tools TC control system. (265x142x50mm, 1.18 kilos)

Ratchet spanners 5/16" 3/8" 7/16" 1/2" 9/16" 5/8" 11/16" 3/4"



TT6508RF Ratcheting combination spanner set

8 piece flexible ratcheting spanner set. Combined ring/open ended spanner and 12 point ring ratchet with 180° flexible joint. Same size at both ends, open end offset at a 13° angle. Chrome vanadium. Supplied in the unique Teng Tools TC tray with removable lid and dove tail joints for use on it's own or as part of the Teng Tools TC control system. Satin finish. (265x142x50mm, 1.1 kilos)

Ratchet spanners 8, 10, 11, 12, 13, 14, 17, 19mm



TT6508RS Ratcheting combination spanner set

8 piece ratcheting combination spanner set. Combined ring/open ended spanners with 12 point ring. 72 teeth ratchet action for rapid tightening and loosening. Same size at both ends. Chrome vanadium. Satin finish. Supplied in the unique Teng Tools TC tray with removable lid and dove tail joints for use on it's own or as part of the Teng Tools TC control system. (265x142x50mm, 1.14 kilos)

Ratchet spanners 8, 10, 11, 12, 13, 14, 17, 19mm



TT6511RS Ratcheting combination spanner set

11 piece ratcheting combination spanner set. Combined ring/open ended spanners with 12 point ring. 72 teeth ratchet action for rapid tightening and loosening. Same size at both ends. Chrome vanadium. Satin finish. Supplied in the unique Teng Tools TC tray with removable lid and dove tail joints for use on it's own or as part of the Teng Tools TC control system. (265x142x50mm, 1.34 kilos)

Ratchet spanners 8, 10, 11, 12, 13, 14, 15, 16, 17, 18, 19mm



TTX6311 Double ring spanner set

11 piece double ring spanner set ranging from 6x7mm to 30x32mm. Chrome vanadium steel. DIN 838/ISO 3318. Satin finish. Supplied in the unique Teng Tools TTX tray for use on it's own or as part of the Teng Tools TC control system. (570x115x60mm, 2.9 kilos)

Double ring spanners 6 x 7mm, 8 x 9mm, 10 x 11mm, 12 x 13mm, 14 x 15mm, 16 x 17mm, 18 x 19mm, 20 x 22mm, 21 x 23mm, 24 x 27mm, 30 x 32mm



TTXFLS06 Extra Long Double Ring Spanner Set

6 piece extra long double ring spanner set ranging from 8x10mm to 22x24mm. 12 point rings at each end. Chrome vanadium. Supplied in the unique Teng Tools drawer width TTX tray for use on it's own or as part of the Teng Tools TC control system. (570x115x70mm, 6.5 kilos)

Double ring spanners 8x10, 11x13, 12x14, 16x18, 17x19, 22x24mm



TT6208 Double open ended spanner set

Set of 8 double open ended spanners. Chrome vanadium steel. Polished heads. DIN3110. Supplied in the unique Teng Tools TC tray with removable lid and dove tail joints for use on it's own or as part of the Teng Tools TC control system. (265x142x50mm, 0.8 kilos)

Double open ended spanners 6x7mm, 8x9mm, 10x11mm, 12x13mm, 14x15mm, 16x17mm, 18x19mm, 20x22mm



TT6506 Double flex wrench set

6 piece double flex wrench set, with different size 12 point sockets at each end. Satin finish. Chrome vanadium. Supplied in the unique Teng Tools TC tray with removable lid and dove tail joints for use on it's own or as part of the Teng Tools TC control system. (265x142x50mm, 1.57 kilos)

Double flex wrenches 8x9mm, 10x11mm, 12x13mm, 14x15mm, 16x17mm, 18x19mm



TTRORS RORS wrench set

6 fibre reinforced chrome vanadium steel ratcheting offset ring spanners. Double ended with 25° 12 point heads (6-8mm 6 point). Reversible action. Satin finish. Supplied in the unique Teng Tools TC tray with removable lid and dove tail joints for use on it's own or as part of the Teng Tools TC control system. (265x142x50mm, 1.26 kilos)

RORS wrenches 6 x 8mm, 7 x 9mm, 10 x 13mm, 12 x 14mm, 17 x 19mm, 21 x 22mm



Tool Control System

TTXQRS07 Quick wrench set

A set of 7 wrenches especially designed for loosening and tightening pipe and hose couplings. Ideal for use in confined spaces. The ring end has a clever design so that it opens up to easily access the nut on the coupling. Supplied in the unique Teng Tools TTX tray for use on it's own or as part of the Teng Tools TC control system. (570x115x60mm, 1.88 kilos)

Quick wrenches	13, 17, 19, 22, 24, 27, 32mm
----------------	------------------------------



TTHP08 Hook wrench set

Set consisting of 3 combined pin/hook spanners with 3 pin adaptors and 2 spare pins with 6 and 8mm diameters. Supplied in the unique Teng Tools TC tray with removable lid and dove tail joints for use on it's own or as part of the Teng Tools TC control system. (265x142x50mm, 1.1 kilos)

Hook handles	3/4" to 2", 1 1/2" to 3", 2" to 4 1/2"
Pin adaptors	4mm, 5mm, 6mm
Pins	6mm, 8mm



TTADJ04 Adjustable wrench set

Set containing 3 Teng Tools adjustable wrenches with TPR grip handles and the 8" wide jaw opening adjustable wrench with vinyl grip. Supplied in the unique Teng Tools TC tray with removable lid and dove tail joints for use on it's own or as part of the Teng Tools TC control system. (265x142x50mm, 1.37 kilos)

Adjustable wrenches	6" (23.9mm capacity)
	8" (28.6mm capacity)
	10" (32.8mm capacity)
	8" wide jaw (38.6mm capacity)



TTHEX7 T Handle hex key set

Set of 7 hex keys with T handle. The ball point head on the long key end improves access. Supplied in the unique Teng Tools TC tray with removable lid and dove tail joints for use on it's own or as part of the Teng Tools TC control system. (265x142x50mm, 0.72 kilos)

T handle driver	hex/ball point	100mm (long arm)	2.5, 3, 4mm
T handle driver	hex/ball point	150mm (long arm)	5, 6, 7mm
T handle driver	hex/ball point	190mm (long arm)	8mm



TTHEX7S Individual Metric T Handle Hex Drivers **NEW!**

Set of hex keys with T handle. Both ends with regular hexagon fitting. (ie. no ball point) Supplied in the unique Teng Tools TC tray with removable lid and dove tail joints for use on it's own or as part of the Teng Tools TC control system. (265x142x50mm, 0.8 kilos)

T handle driver	hex point	100mm (long arm)	2.5, 3, 4mm
T handle driver	hex point	150mm (long arm)	5, 6, 7mm
T handle driver	hex point	190mm (long arm)	8mm



TTHEX7AF T Handle AF hex key set

Set of 7 hex keys with T handle. The ball point head on the long key end improves access. Supplied in the unique Teng Tools TC tray with removable lid and dove tail joints for use on it's own or as part of the Teng Tools TC control system. (265x142x50mm, 0.75 kilos)

T handle driver	hex/ball point	100mm (long arm)	3/32" 1/8" 5/32"
T handle driver	hex/ball point	150mm (long arm)	3/16" 7/32" 1/4"
T handle driver	hex/ball point	190mm (long arm)	5/16"



Tool Control System

TTTX7 T Handle hex key set

Set of 7 TX keys with T handle. For internal TX heads (also for tamper proof screws). Supplied in the unique Teng Tools TC tray with removable lid and dove tail joints for use on it's own or as part of the Teng Tools TC control system. (265x142x50mm, 0.72 kilos)

T handle driver	TX/TPX	100mm (long arm)	TX/TPX10, TX/TPX15, TX/TPX20
T handle driver	TX/TPX	150mm (long arm)	TX/TPX25, TX/TPX27, TX/TPX30
T handle driver	TX/TPX	190mm (long arm)	TX/TPX40



TTHT28 Hex key set

Set of 28 Hex keys, (metric and AF) and TX keys. Supplied in the unique Teng Tools TC tray with removable lid and dove tail joints for use on it's own or as part of the Teng Tools TC control system. (265x142x50mm, 1.22 kilos)

Hex keys	mm	1.5, 2.0, 2.5, 3.0, 4.0, 5.0, 6.0, 7.0, 8.0, 10.0
Hex keys	AF	5/64" 3/32" 1/8" 5/32" 3/16" 7/32" 1/4" 5/16" 3/8"
TX key	TX	TX8, TX9, TX10, TX15, TX20, TX25, TX27, TX30, TX40



TTXMDN Nut driver set

9 piece nut driver set with chrome vanadium steel blades, 6 point opening and ergonomically designed bi-material handles with hanging hole. Supplied in the unique Teng Tools TTX tray for use on it's own or as part of the Teng Tools TC control system. (570x115x40mm, 1.6 kilos)



Nut drivers	5, 5.5, 6, 7, 8, 10, 11, 12, 13mm
-------------	-----------------------------------

TTSD39 Torque screwdriver set

1/4" drive torque screwdriver with "slipper" mechanism for when torque is reached. Supplied with 36 bits, 4" extension bar and bit chuck holder. Supplied in the unique Teng Tools TC tray with removable lid and dove tail joints for use on it's own or as part of the Teng Tools TC control system. (265x142x50mm, 0.66 kilos)

25mm Bits	1/4" hex	PH0, PH1, PH2, PH3		
		PZ0, PZ1, PZ2, PZ3		
		TX8, TX9, TX10, TX15, TX20, TX25, TX27, TX30, TX40		
		TPX10, TPX15, TPX20, TPX25, TPX30		
		ROB1, ROB2, ROB3		
		GR PH2x2 pc		
		hex 2, 3, 4, 5, 6mm		
		flat 3.0x0.5mm, 4.5x0.6mm 5.5x0.8mm, 6.5x1.2mm		
		Accessories	1/4" drive	torque screwdriver 1-5Nm, 4" extension bar
			1/4" hex	bit chuck holder



TTX3892 3/8" Torque Wrench set

22 piece set consisting of a 3/8" drive torque wrench, 10 crow foot wrenches, bit adaptor, 8 TX bits, 3" and 5" extension bars. Supplied in the unique Teng Tools TTX tray for use on it's own or as part of the Teng Tools TC control system. (570x115x60mm, 0.9 kilos)



Torque wrench	3/8" drive	angular gauge torque wrench (20-110Nm, 15-75 ft/lb)
Accessories	3/8" drive	3" and 5" extensions, adaptor for 10mm hex bits
TX bits	10mm hex drive	TX8, TX10, TX15, TX20, TX25, TX27, TX30, TX40
Crow foot wrenches	3/8" drive	10, 11, 12, 13, 14, 15, 16, 17, 18, 19mm

TTX1292 1/2" Torque Wrench set

1/2" drive torque wrench with built in angular gauge (40-210Nm/30-150ft/lb) in a TTX tool tray. Supplied in the unique Teng Tools TC tray for use on it's own or as part of the Teng Tools TC control system. (570x115x60mm, 1.6 kilos)



Torque wrench 1/2" drive angular torque wrench (40-210Nm, 30-150ft/lb)

TTPSTQ04 Preset Torque Wrench set

4 piece 1/2" drive preset torque wrenches, set to 90, 110, 120 and 140Nm. Accuracy to +/- 4%, with rubber handle and supplied with a separate wall rack. DIN 3122. Supplied in the unique Teng Tools tray for use on it's own or as part of the Teng Tools TC control system. (570x262x73mm, 5.80 kilos)



1/2" drive preset torque wrenches 90, 110, 120, 140Nm

TTXMP12 Torque Multiplier set

A 1292AG-EP 1/2" drive tested and certified 210Nm torque wrench together with an MP1400 torque multiplier that converts the torque at a ratio of 3:1 up to a maximum torque capacity of 1,500Nm with a 3/4" male square drive. Supplied in the unique Teng Tools TTX tray for use on it's own or as part of the Teng Tools TC control system. (570x115x60mm, 4.0 kilos)



Torque wrench 1/2" drive angular gauge covering 40 to 210Nm (1292AG-EP)
Torque multiplier 1/2" F:3/4" M torque multiplier (3 to 1 ratio) and maximum torque capacity 1,500Nm (MP1400)

TT917N 7 Piece Screwdriver set

7 piece screwdriver set including flat as well as PH and PZ types. Features include TT-MV PLUS steel blades and ergonomically designed bi-material handles with hanging hole and T drive facility for added torque and comfort. Supplied in the unique Teng Tools TC tray with removable lid and dove tail joints for use on it's own or as part of the Teng Tools TC control system. (265x142x50mm, 0.7 kilos)



Screwdrivers	Flat regular	3x75mm, 5.5x75mm, 6.5x100mm
Screwdrivers	PH type	PH0x75mm, PH1x75mm, PH2x100mm
Screwdrivers	PZ type	PZ2x100mm

TTD914N 14 Piece Screwdriver set

14 piece screwdriver set including flat as well as PH and PZ types. Features include TT-MV PLUS steel blades and ergonomically designed bi-material handles with hanging hole and T drive facility for added torque and comfort. Supplied in the unique Teng Tools double TC tray with removable lid and dove tail joints for use on it's own or as part of the Teng Tools TC control system. (265x248x50mm, 1.2 kilos)



Screwdrivers	Flat regular	3x75mm, 3.5x100mm, 5.5x75mm, 5.5x125mm, 6.5x38mm stubby, 6.5x100mm
Screwdrivers	PH type	PH0x75mm, PH1x75mm, PH2x38mm stubby, PH2x100mm
Screwdrivers	PZ type	PZ0x75mm, PZ1x75mm, PZ2x38mm stubby, PZ2x100mm

TT917TXN 7 Piece Screwdriver set

7 piece driver set covering TX8 through to TXP30. Features include TT-MV PLUS steel blades and ergonomically designed bi-material handles with hanging hole and T drive facility for added torque and comfort. Supplied in the unique Teng Tools TC tray with removable lid and dove tail joints for use on it's own or as part of the Teng Tools TC control system. (265x142x50mm, 0.7 kilos)



TX drivers	TX type	TX8x75mm, TX9x75mm TPX10x100mm, TPX15x100mm, TPX20x100mm, TPX25x100mm, TPX30x100mm
------------	---------	---

TTD912TXN 12 Piece Screwdriver set

12 piece TX driver set covering TX6 through to TX45. Features include TT-MV PLUS steel blades and ergonomically designed bi-material handles with hanging hole and T drive facility for added torque and comfort. Supplied in the unique Teng Tools double TC tray with removable lid and dove tail joints for use on it's own or as part of the Teng Tools TC control system. (265x284x50mm, 1.2 kilos)



TX drivers	TX type	TX6x75mm, TX7x75mm, TX8x75mm, TX9x75mm TX10x100mm, TX15x100mm, TX20x100mm, TX25x100mm TX27x100mm, TX30x100mm, TX40x100mm, TX45x125mm
------------	---------	--

TTMD12D Screwdriver set

Set of 12 interchangeable screwdriver blades including TX, hex as well as Phillips and Pozidrive heads. With chrome vanadium steel blades. Supplied in the unique Teng Tools TC tray with removable lid and dove tail joints for use on it's own or as part of the Teng Tools TC control system. (265x142x50mm, 0.6 kilos)



Screwdrivers		Changeable handle for 1/4" shank
Screwdrivers	TX Type	TX10xTX15, TX20xTX25, TX30xTX40
Screwdrivers	Hex type	Hex ball 3.0 x Hex 3.0mm, Hex ball 4.0 x Hex 4.0mm, Hex ball 5.0 x Hex 5.0mm, Hex ball 6.0 x Hex 6.0mm
Screwdrivers	PH type	PH1 x PH2, PH3 x Flat 6.5mm
Screwdrivers	Flat regular type	4.0 x 5.5mm

TTMD74 Ratcheting bits driver set

74 piece set including ratcheting bits driver, 6" flexible extension, 69 bits, 4" extension bar, coupler adaptors. Supplied in the unique Teng Tools TC tray with removable lid and dove tail joints for use on it's own or as part of the Teng Tools TC control system. (265x142x50mm, 0.74 kilos)



Accessories	1/4" drive	ratcheting bits handle including 6 bits PH1, PH2, PZ1, PZ2, 5 & 7mm flat, 6" flexible extension, 4" extension, 1/4" M:1/4" hex adaptor coupler, 1/4" F:1/4" hex coupler adaptor.
25mm hex bits	1/4" hex drive	TX6, 7, 8, 9, 10, 15, 20x3, 25x3, 27, 30, 40.TPX10, 15, 20x2, 25x2, 27, 30, 40, 2, 3, 4, 5, 6, 8mm hex, 0.6x3.5, 0.6x4.5, 0.8x4.0, 0.8x5.5, 1.0x5.5, 1.2x5.0, 1.2x6.5, 1.4x7.0, 1.6x8.0mm flat, PH1x4, PH2x7, PH3x1, PZ1x4, PZ2x7, PZ3x1, 1, 2, 3 square, GR

TTMDRT64 Angled Ratcheting bits Driver Set

64 piece set including jointed bits driver with adjustable angle setting, 11 regular 1/4" drive metric sockets and 52 bits. Supplied in the unique Teng Tools TC tray with removable lid and dove tail joints for use on it's own or as part of the Teng Tools TC control system. (265x142x50mm, 0.85 kilos)

Accessories	1/4" drive	ratcheting bits handle including 7 bits 5 & 7mm flat, PH1, PH2, PZ1, PZ2, 1/4"M:1/4" hex adaptor.
Regular sockets	1/4" drive	4, 5, 5.5, 6, 7, 8, 9, 10, 11, 12, 13mm
25mm bits	1/4" hex drive	0.6x3.5, 0.6x4.5, 0.8x4.0, 0.8x5, 0.8x5.5, 1.0x5.5, 1.2x6.5, 1.2x7.0, 1.6x8.0 flat, PH1 x 4, PH2 x 4, PH3 x 2, PZ1, PZ2 x 3, PZ3 x 2, TX6, TX7, TX8, TX9, TX10, TX15, TX20 x 3, TX25 x 3, TX27, TX30, TX40, 2, 3, 4(x 3), 5, 6, 8mm hex, 1, 2, 3 square.



TTXMD41N Flexible handle 1/4" drive Socket and Screwdriver Bit Set

NEW!

Set of two flexible drivers together with 1/4" drive sockets and a selection of the most commonly used screwdriver bits. Supplied in the unique Teng Tools TTX tray for use on it's own or as part of the Teng Tools TC control system. (570x115x70mm, 1.36 kilos)

Accessories		555mm flexible spinner handle with 1/4" drive, 555mm flexible bits driver with 1/4" hex drive, 1/4" x 1/4" hex adaptor
Regular sockets	1/4" drive	4, 4.5, 5, 5.5, 6, 7, 8, 9, 10, 11, 12, 13mm
25mm hex bits	1/4" hex drive	0.8x4.0, 1.0x5.5, 1.6x8.0mm flat, PH0, PH1, PH2, PH3, PH4, PZ0,PZ1, PZ2, PZ3, TX8, TX10, TX15, TX20, TX25,



TTX918N 8 Piece Screwdriver Set

8 piece screwdriver set including flat, regular and PH types with ergonomically designed bi-material handle with hanging hole. Supplied in the unique Teng Tools TTX tray for use on it's own or as part of the Teng Tools TC control system. (570x115x40mm, 1.0 kilos)

Screwdrivers	Flat regular	6.5 x 38mm stubby, 3 x 100mm, 6.5 x 100mm, 10 x 200mm, 5.5 x 150mm, 8 x 150mm
Screwdrivers	PH type	PH2 x 38mm stubby, PH3 x 150mm

TTXMDTN

5 Piece Power Thru Screwdriver Set

5 piece power thru screwdriver set including flat, regular and PH types with ergonomically designed bi-material handle with hexagonal power thru blade and percussion cap in head of the handle. Supplied in the unique Teng Tools TTX tray for use on it's own or as part of the Teng Tools TC control system. (570x115x40mm, 1.4 kilos)



Power thru screwdrivers	Flat regular	6.5 x 100mm, 8 x 150mm, 10 x 200mm
	PH type	PH2 x 100mm, PH3 x 150mm

TTV706N 1,000 Volt Insulated Screwdriver With Reduced Blade Diameter Set

NEW!

All produced and tested according to the EN60900 standard. Approved for working up to 1,000 volt AC. Supplied in the unique Teng Tools TC tray with removable lid and dove tail joints for use on it's own or as part of the Teng Tools TC control system. (265x142x50mm, 0.60 kilos)

Screwdrivers	Flat type	0.8x4.0x100, 1.0x5.5x125mm
Screwdrivers	PH type	PH1x80, PH2x100mm
Screwdrivers	PZ type	PZ1x80, PZ2x100mm



TTV907N Insulated Screwdriver Set

Set of seven 1,000 volt insulated screwdrivers including flat as well as PH and PZ types. Features include TT-MV PLUS steel blades and ergonomically designed bi-material handles with hanging hole and T drive facility for added torque and comfort. All produced and tested according to the EN60900 standard. Approved for working up to 1,000 volt AC. Supplied in the unique Teng Tools TC tray with removable lid and dove tail joints for use on it's own or as part of the Teng Tools TC control system. (265x142x50mm, 0.65 kilos)

Screwdrivers	Flat type	2.5x75mm, 4.0x100mm, 5.5x125mm
	PH type	PH0 x 60mm, PH1 x 80mm, PH2 x 100mm
	PZ type	PZ2 x 100mm



TTDV910N 10 Piece Insulated Screwdriver Set

Set of ten 1,000 volt insulated screwdrivers including flat as well as PH and PZ types. Features include TT-MV PLUS steel blades and ergonomically designed bi-material handles with hanging hole and T drive facility for added torque and comfort. All produced and tested according to the EN60900 standard. Approved for working up to 1,000 volt AC. Supplied in the unique Teng Tools double TC tray with removable lid and dove tail joints for use on it's own or as part of the Teng Tools TC control system. (265x284x50mm, 1.2 kilos)

Screwdrivers	Flat type	2.5x75mm, 3.0x100mm, 4.0x100mm, 5.5x125mm
	PH type	PH0 x 60mm, PH1 x 80mm, PH2 x 100mm
	PZ type	PZ0x60mm, PZ1x80mm, PZ2 x 100mm



TTM16 Mini plier & screwdriver set

Set containing 12 mini screwdrivers and 4 mini pliers. Supplied in the unique Teng Tools TC tray with removable lid and dove tail joints for use on it's own or as part of the Teng Tools TC control system. (265x142x50mm, 0.71 kilos)

Screwdrivers	Flat regular	2.0, 2.4, 3.0
	PH type	PH00, PH0, PH1
	TX type	TX6, TX7, TX8, TX9, TX10, TX15
Pliers		4 1/2" side cutter, 4 1/2" end cutter, 5" long nose, 5" flat nose



TT440 Plier set

Set of 4 Mega Bite pliers: water pump pliers, combination pliers, side cutters and long nose pliers. Made of chrome molybdenum steel. Plastic covered handles. Supplied in the unique Teng Tools TC tray with removable lid and dove tail joints for use on it's own or as part of the Teng Tools TC control system. (265x142x50mm, 1.1 kilos)

Pliers	6" side cutter, 7" combination, 8" long nose, 10" water pump
--------	--



TTD441 8 Piece Plier Set

8 piece plier set made of chrome molybdenum with plastic covered handles for grip and comfort. Includes side cutters, combination pliers, long nose pliers and water pump pliers. Supplied in the unique Teng Tools double TC tray with removable lid and dove tail joints for use on it's own or as part of the Teng Tools TC control system. (265x284x50mm, 1.8 kilos)

Side cutters	heavy duty	6", 8" (2.5mm/3.0mm piano wire cutting capacity)
Combination pliers	high leverage	6", 8" (1.6mm/2.0mm piano wire cutting capacity)
Long nose pliers		6", 8" (1.0mm/1.5mm piano wire cutting capacity)
Water pump pliers		7", 10" (25mm/38mm capacity)



Tool Control System

TT440-T Plier set

Set of 4 Mega Bite pliers: water pump pliers, combination pliers, side cutters and long nose pliers. Chrome molybdenum steel with TPR grips. Supplied in the unique Teng Tools TC tray with removable lid and dove tail joints for use on it's own or as part of the Teng Tools TC control system. (265x142x50mm, 1.3 kilos)

TPR grip handles	6" side cutter, 7" combination, 8" long nose, 10" water pump
------------------	--



TTD441-T 8 Piece Plier Set

8 piece plier set made of chrome molybdenum with TPR grip bi-material handles for extra grip and comfort. Includes side cutters, combination pliers, long nose pliers and water pump pliers. Supplied in the unique Teng Tools double TC tray with removable lid and dove tail joints for use on it's own or as part of the Teng Tools TC control system. (265x284x50mm, 2.0 kilos)

Side cutters	heavy duty	6", 8" (2.5mm/3.0mm piano wire cutting capacity)
Combination pliers	high leverage	6", 8" (1.6mm/2.0mm piano wire cutting capacity)
Long nose pliers		6", 8" (1.0mm/1.5mm piano wire cutting capacity)
Water pump pliers		7", 10" (25mm/38mm capacity)



TTXMB02 Water Pump Plier and Adjustable Wrench Set

NEW!

Two really handy tools in one TTX tray for use on it's own or as part of the Teng Tools TC control system. The set includes the MB482-10Q Quick adjust 10" water pump plier and the 4003J 10" "Alligator" adjustable wrench with pipe grip. (570x115x40mm, 1.0 kilos).

Wrenches	10"	Alligator adjustable
Pliers	10"	Quick action water pump



TTV440 Insulated plier set

4 piece Mega Bite insulated plier set, all produced and tested according to the EN 60900 standard. Approved for live working up to 1000 volt AC. Supplied in the unique Teng Tools TC tray with removable lid and dove tail joints for use on it's own or as part of the Teng Tools TC control system. (265x142x50mm, 1.1 kilos)

Pliers	6" side cutter (capacity 0.5mm piano wire) 7" combination (capacity 2.0mm piano wire), 8" long nose, 7" wire stripper (capacity 0.2-3.0mm).
--------	---



TT474-5 Circlip plier set

Set consisting of 4 Mega Bite circlip pliers (2 straight tip and 2 bent tip pliers for internal and external circlips). Fitted with return spring. Supplied in the unique Teng Tools TC tray with removable lid and dove tail joints for use on it's own or as part of the Teng Tools TC control system. (265x142x50mm, 0.5 kilos)

5" Circlip pliers	inner/straight (10 to 25mm capacity)	inner/bent (10 to 25mm capacity)
	outer/straight (10 to 25mm capacity)	outer/bent (10 to 25mm capacity)



Tool Control System

TT474-7 Circlip plier set

Set consisting of 4 Mega Bite circlip pliers (2 straight tip and 2 bent tip pliers for internal and external circlips). Fitted with return spring. Supplied in the unique Teng Tools TC tray with removable lid and dove tail joints for use on it's own or as part of the Teng Tools TC control system. (265x142x50mm, 1.0 kilos)

7" Circlip pliers	inner/straight (19 to 60mm capacity)	inner/bent (19 to 60mm capacity)
	outer/straight (19 to 60mm capacity)	outer/bent (19 to 60mm capacity)



TT474-7E 7" Circlip Pliers Set **NEW!**

Set consisting of 4 Mega Bite circlip pliers with invisible spring design with non slip bearing steel points for heavy duty applications. Supplied in the unique Teng Tools TC tray with removable lid and dove tail joint for use on it's own or as part of the Teng Tools TC control system. (265x142x50mm, 0.924 kilos)

7" Circlip pliers	inner/straight (19 to 60mm capacity)	inner/bent (19 to 60mm capacity)
	outer/straight (19 to 60mm capacity)	outer/bent (19 to 60mm capacity)



TTX474-9 Circlip plier set

4 piece Mega Bite circlip plier set consisting of 2 straight tip and 2 bent tip pliers for internal and external circlips. Fitted with return spring. Supplied in the unique Teng Tools TTX tray for use on it's own or as part of the Teng Tools TC control system. (570x115x40mm, 1.5 kilos)

9" Circlip pliers	inner/straight (40 to 100mm capacity)	inner/bent (40 to 100mm capacity)
	outer/straight (40 to 100mm capacity)	outer/bent (40 to 100mm capacity)



TTVG05 Power grip pliers

Set consisting of 5 power grip pliers : 4", 7" and 10" round jaw, 4" and 6" long nose. Supplied in the unique Teng Tools TC tray with removable lid and dove tail joints for use on it's own or as part of the Teng Tools TC control system. (265x142x50mm, 1.5 kilos)

Pliers	4" Power Grip Plier
	4" Long Nose Power Grip
	6" Long Nose Power Grip
	7" Power Grip
	10" Power Grip



TTZVG03 Power Grip Pliers **NEW!**

A storage tray half the size of a TTX tray with three of the most commonly used power grip pliers. Can be used on it's own or as part of the Teng Tools TC control system. (285x115x40mm, 0.56 kilos)

Pliers	4" Power Grip Plier
	4" Long Nose Power Grip Plier
	6" Long Nose Power Grip Plier



TTSPG Welding plier set

4 piece set containing C clamp, welding, sheet metal and 6" long nose power grip pliers. Supplied in the unique Teng Tools PS tray for use on it's own or as part of the Teng Tools TC control system. (540x265x40mm, 2.3 kilos)

Power grip pliers 11" C clamp, 9" welding grip, 8" sheet metal grip, 6" long nose



TTNF12 Needle file set

Set of 12 needle files. Supplied in the unique Teng Tools TC tray with removable lid and dove tail joints for use on it's own or as part of the Teng Tools TC control system. (265x142x50mm, 0.47 kilos)

Needle files hand, half round, three square, square, round, flat point, knife type, barrette, crossing, oval, feather edge, round edge flat



TTXF05 Hand file set

Set of 5 files, flat, hand, half round, round, three square. Supplied in the unique Teng Tools TTX tray for use on it's own or as part of the Teng Tools TC control system. (570x115x40mm, 1.0 kilos)

Contains 10" files Flat, Hand, Half Round, Round, Three square



TTDCT05 Cutting tool set

Set containing two tin snips, utility knife, scissors and a HD cable cutter. Supplied in the unique Teng Tools double TC tray with removable lid and dove tail joints for use on it's own or as part of the Teng Tools TC control system. (265x284x50mm, 2.1 kilos)

Tin Snips (491)	Straight/right
Tin Snips (492)	Straight/left
Utility knife (710N)	
Scissors (497)	
HD Cable Cutters (496)	Capacity 2AWG



TTK40 Knife Set

A handy set of knives for different uses in one convenient set. Supplied in the unique Teng Tools TC tray with removable lid and dove tail joints for use on it's own or as part of the Teng Tools TC control system. (265x142x50mm, 1.7 kilos)

Knives	utility knife with auto load function	Spare blades	5 x Regular knife blades
	folding universal knife		10 x Mini knife blades
	folding mini utility knife		10 x 9mm Snap off blades
	hobby knife with 9mm blade		10 x 18mm Snap off blades
	hobby knife with 18mm blade		



TTOS16 Oil service set

Set consisting of 6 double ended drain plug sockets, 16 and 21mm 6 point spark plug sockets, oil filter wrench, 3" and 10" wobble extension bars, 1/2"-3/8" adaptor, telescopic inspection mirror with magnet and a set of feeler gauges. Supplied in the unique Teng Tools TC tray with removable lid and dove tail joints for use on it's own or as part of the Teng Tools TC control system. (265x142x50mm, 1.8 kilos)

Accessories	3", 10" wobble extensions, 1/2" F 3/8" Male T bar adaptor, 6 point 21mm socket
Spark plug sockets	3/8" drive 16, 21mm
Drain plug set	bar, 5/16" hex x 3/8" hex, 11mm square x 12mm hex, 17mm hex x 1/2" hex, 8mm square x 3/8" square, 13mm square x 14mm hex, 8mm hex x 10mm hex
Accessories	strap type oil filter wrench, 3 in 1 telescopic inspection tool, 21 piece feeler gauge set (.005 mm - 1.0 mm)



TTSR04 Scraper set

4 piece set consisting of scraper, hooks and an awl. A multi purpose tool kit. Supplied in the unique Teng Tools TC tray with removable lid and dove tail joints for use on it's own or as part of the Teng Tools TC control system. (265x142x50mm, 0.4 kilos)

Gasket scraper	22mm wide blade, total length 245mm
Hooks & awl	curved hook, 90° hook and awl



TTSS07 Specialist socket set

Specialist socket set containing 2 oxygen sensor sockets, injector socket, vacuum switch socket, oil sender socket, heated oxygen sensor socket and offset oxygen sensor socket. Supplied in the unique Teng Tools TC tray with removable lid and dove tail joints for use on it's own or as part of the Teng Tools TC control system. (265x142x50mm, 3.5 kilos)

29mm	1/2" drive	90mm in length	Oxygen sensor socket for GM
22mm	3/8" drive	90mm in length	Oxygen sensor socket for Mitsubishi, Nissan, Opel, Vauxhall and VW
27mm	1/2" drive	85mm in length	Injector socket for M24
7/8	3/8" drive	80mm in length	Vacuum switch socket
1 1/8	3/8" drive	74mm in length	Oil sender socket
7/8	1/2" drive	50mm in length	Heated oxygen sensor socket
7/8	3/8" drive	30mm in length	Offset oxygen sensor socket



TT804 Puller set

Set consisting of a three legged combination puller with an extra yoke for switching to two legged pulling. With reversible legs for internal and external grip. Chrome vanadium. Supplied in the unique Teng Tools TC tray with removable lid and dove tail joints for use on it's own or as part of the Teng Tools TC control system. (265x142x50mm, 1.2 kilos)

Puller set	combination twin/triple 6" leg puller with 4" capacity
------------	--



TTHC03 Hose clamp set

Special designed jaws to prevent internal hose linings from damage. Lightweight, easy to use and non conductive. 3 sizes to fit all types of hose. Supplied in the unique Teng Tools TC tray with removable lid and dove tail joints for use on it's own or as part of the Teng Tools TC control system. (265x142x50mm, 0.5 kilos)

Hose clamps	for hoses 1/4"-3/4", 1/4"-1 1/4", 3/4"-2 1/4"
-------------	---



TTTF10 Flaring tool set

Comprehensive tube flaring kit, suitable for copper, brass and thin walled aluminium tubing. 45° tube press flare pipes from 3/16" to 5/8" diameter. The pipe cutter can cut up to 30mm diameter. Includes spare cutting wheel inside the handle. Supplied in the unique Teng Tools TC tray with removable lid and dove tail joints for use on it's own or as part of the Teng Tools TC control system. (265x142x50mm, 1.7 kilos)

Pipe Cutter	3-32mm (1/8" - 1/4")
2 piece double flaring tool set	
Adaptors	4, 4.75 (3/16"), 6 (1/4"), 8 (5/16"), 10, 12, 14mm



TTTS08 Torque Stick Set

8 piece torque stick and wheel nut set, for tightening wheel nuts on cars. When the intended tightening torque is reached, the socket end stops while the drive end springs back between each stroke. Reduces the risk of sheared wheel bolts or deformed rims. Supplied in the unique Teng Tools TC tray with removable lid and dove tail joints for use on it's own or as part of the Teng Tools TC control system. (265x142x50mm, 2.0 kilos)

1/2" Torque sticks	Nm	90, 110, 120, 140
1/2" Wheel nut sockets	mm	17, 19, 21
Torque step up adaptor	inch	3/8 x 1/2



TTXPB3 Pry bar set

3 piece pry bar set consisting of 12", 16" and 20" bars. Supplied in the unique Teng Tools TTX tray for use on it's own or as part of the Teng Tools TC control system. (570x115x40mm, 1.8 kilos)



Roll/heel bars	12", 16", 20"
----------------	---------------

TTXPB3A Pry bar set

3 piece heavy duty pry bar set with Power Thru handles. Supplied in the unique Teng Tools TTX tray for use on it's own or as part of the Teng Tools TC control system. (570x115x70mm, 1.8 kilos)



Pry bars	12", 18", 22"
----------	---------------

TTCP121 Crimping Tool Set

Set consisting of crimping tool CP50 with slots for crimping red, blue and yellow terminals and cutters for bolts and wire. Also included in the assortment are 120 terminals of varying types coloured red and blue. Supplied in the unique Teng Tools TC tray with removable lid and dove tail joints for use on it's own or as part of the Teng Tools TC control system. (265x142x50mm, 0.6 kilos)

Crimping tool	multi function CP50 crimping tool
Terminals/connectors	red #6 ring terminals x 20
	blue #8 spade terminals x 20
	red butt connectors x 20
	blue butt connectors x 20
	blue 6.3x0.8mm female connectors x 20
	blue 6.3x0.8mm male connectors x 20



TTCP04 Crimping tool set

Set consisting of ratchetting crimping tool with interchangeable heads to use on insulated, non-insulated and non-insulated barrel type connectors. Supplied in the unique Teng Tools TC tray with removable lid and dove tail joints for use on it's own or as part of the Teng Tools TC control system. (265x142x50mm, 0.8 kilos)

Changeable ratchet crimping tool	for insulated terminals 22-10 AWG (0.324 square mm - 5.261 square mm)
Die for non-insulated open barrel connector, commercial type	for non-insulated open barrel connector, commercial type 22-12 AWG (0.324 square mm - 3.31 square mm)
Die for non-insulated terminals	for non-insulated terminals 22-8 AWG (0.3 square mm - 8 square mm)
Hex key wrench	2.5mm



TTSN11 Extractor set

Combined set of 5 screw extractors, 4 bolt extractors and 2 nut splitters. Supplied in the unique Teng Tools TC tray with removable lid and dove tail joints for use on it's own or as part of the Teng Tools TC control system. (265x142x50mm, 1.3 kilos)

Stud extractors	1/2" drive	6, 8, 10, 12mm
Screw extractors	7/64" 9/64" 5/32" 1/4" 19/64"	
Nut splitters		5 to 20mm, 14 to 27mm



TTBE18 3/8" & 1/2" Drive Stud Extractor set

3/8" drive (6-17mm) and 1/2" drive (19-25mm) stud extractor sockets plus a 4mm parallel pin punch. Chrome vanadium, satin finish. Supplied in the unique Teng Tools TC tray with removable lid and dove tail joints for use on it's own or as part of the Teng Tools TC control system. (265x142x50mm, 1.5 kilos)

3/8" stud extractors	mm	6, 8, 10, 11, 12, 13, 14, 16, 17mm
	AF	5/16" 3/8" 7/16" 1/2" 9/16" 5/8"
1/2" stud extractors	mm	19, 21, 22, 24, 25mm
	AF	3/4" 13/16", 7/8" 15/16" 1"
Parallel pin punch		4mm, 150mm length



TTDB28 Drill Bit Set

28 piece drill bits set with a spiral angle of 28° and a split point of 118° for use on steel and cast iron. DIN 338. Supplied in the unique Teng Tools TC tray with removable lid and dove tail joints for use on it's own or as part of the Teng Tools TC control system. (265x142x50mm, 0.6 kilos)

Performance	Fully Ground
Drills diameter	mm 1.0 (x3), 1.5 (x3), 2.0 (x2), 2.5 (x2), 3.0, 3.5, 4.0, 4.5, 5.0, 5.5, 6.0, 6.5, 7.0, 7.5, 8.0, 8.5, 9.0, 10.0, 10.5, 11.0, 12.0, 13.0
Shank	same as drills diameter



TTTM03 Inspection tool set

3 piece inspection set including an inspection mirror, a magnifying glass and a magnetic pick up. All with pocket clips. Supplied in the unique Teng Tools TC tray with removable lid and dove tail joints for use on it's own or as part of the Teng Tools TC control system. (265x142x50mm, 0.5 kilos)

Telescopic magnifying glass
Telescopic inspection mirror
Telescopic magnetic pick up tool



TTM08 Inspection tool set

Containing flexible and telescopic pick ups, magnifying glass, inspection mirror, flexible claw pick up, LED torch and batteries. Supplied in the unique Teng Tools TC tray with removable lid and dove tail joints for use on it's own or as part of the Teng Tools TC control system. (265x142x50mm, 1.1 kilos)

LED flashlight	
Flexible magnetic pick up	length 310mm
Telescopic magnetic pick up	length 160-480mm
38mm magnifying glass 1:3	with magnetic adaptor
38mm inspection mirror	with magnetic adaptor
230mm flexible claw pick up tool	
Batteries AAA (2 pieces)	



TTPSAD Body working hammers

Set of five body working hammers including two dead blow and three metal working hammers. Supplied in the Teng Tools PS tray for use on it's own or as part of the Teng Tools TC control system. (560x265x40mm, 4.5 kilos).

Hammers	dead blow hammers with 35 and 55mm diameter heads, crown face hammers with straight pein, pick heads and square milled face.
---------	--



TTHR81 Rivet gun set

Set containing one rivet gun with four nozzles as well as 75 assorted rivets (2.4, 3.2, 4.0 and 4.8mm). Supplied in the unique Teng Tools TC tray with removable lid and dove tail joints for use on it's own or as part of the Teng Tools TC control system. (265x142x50mm, 1.0 kilos)

Hand rivetter	with four nozzles to suit aluminium/steel blind rivets (2.4, 3.2, 4.0, 4.8mm)
Aluminium rivets	2.4mm (3/32") x 20 black
Aluminium rivets	3.2mm (1/8") x 20 black
Aluminium rivets	4.0mm (5/32") x 20 black
Aluminium rivets	4.8mm (3/16") x 15 black
Accessories	nozzle wrench



TTNR81 Nutsert tool set

Set containing a nutsert gun together with 75 assorted blind nutserts. Supplied in the unique Teng Tools TC tray with removable lid and dove tail joints for use on it's own or as part of the Teng Tools TC control system. (265x142x50mm, 1.0 kilos)

Nut sert tool	with four quick change mandrels (M3 x 0.5, M4 x 0.7, M5 x 0.8, M6 x 1.0)
Accessories	nose piece wrench
Nut serts	M3 x 20 pieces, M4 x 20 pieces, M5 x 20 pieces, M6 x 15 pieces



TTPC09 Punch & chisel set

Combined 9 piece set containing 6 punches, 2 cold chisels and a centre punch. Supplied in the unique Teng Tools TC tray with removable lid and dove tail joints for use on it's own or as part of the Teng Tools TC control system. (265x142x50mm, 1.4 kilos)

Punches	centre	150mm	5mm
	parallel	150mm	3, 4, 5, 6, 7, 8mm
Flat chisels	150mm	19mm	
	200mm	25mm	



TTPS09 General Service Tools

9 piece tool set containing 2 adjustable wrenches, power grip pliers, utility knife, hacksaw frame, soft face hammer, measuring tape, steel rule and ball pein hammer. Supplied in the Teng Tools PS tray for use on it's own or as part of the Teng Tools TC control system. (560x265x40mm, 4.5 kilos)

General tools	6" adjustable wrench, 10" adjustable wrench, 10" power grip plier, utility knife, 12" hack saw, soft face hammer, 3 meter tape measure, 200mm steel rule, 24oz (675g) ball pein hammer
---------------	--



TTPS09E General Service Tools

9 piece tool set containing two adjustable wrenches, power grip pliers, utility knife, hacksaw frame, soft face hammer, measuring tape, steel rule and engineers hammer. Supplied in the Teng Tools PS tray for use on it's own or as part of the Teng Tools TC control system. (560x265x40mm, 4.5 kilos).

General tools	6" adjustable wrench, 10" adjustable wrench, 10" power grip plier, utility knife, 12" hack saw, soft face hammer, 3 meter measuring tape, 200mm steel rule, 800g engineers hammer.
---------------	--



SCPS01 6 Piece Service Tool Set

Service tray with 3 meter measuring tape, 12" hacksaw frame, utility knife, 10" power grip plier, 8" adjustable wrench and a 16oz ball pein hammer. Supplied in a PS tray to fit in the Teng Tools TC-SC service case. (420x265x56mm, 2.5 kilos)

Measuring tape, hacksaw frame, utility knife, power grip plier, adjustable wrench, ball pein hammer.



SCPS01E 6 Piece Service Tool Set

Service tray with 3 meter measuring tape, 12" hacksaw frame, utility knife, 10" power grip plier, 8" adjustable wrench and a 500g engineers hammer. Supplied in a PS tray to fit in the Teng Tools service case. (420x265x56mm, 2.5 kilos)

Measuring tape, hacksaw frame, utility knife, power grip plier, adjustable wrench, engineers hammer.



Tool Control System

TTTD17 Tap & Die set

17 piece set containing one tap and one die of each dimension as well as a tap wrench, a die stock and a screw pitch gauge. Suitable for repairing threads. Supplied in the unique Teng Tools TC tray with removable lid and dove tail joints for use on it's own or as part of the Teng Tools TC control system. (265x142x50mm, 0.8 kilos)

Metric dies	3mm x 0.5, 4mm x 0.7, 5mm x 0.8, 6mm x 1.0, 8mm x 1.25, 10mm x 1.5, 12mm x 1.75
Metric taps	3mm, 4mm, 5mm, 6mm, 8mm, 10mm, 12mm
Accessories	tap handle (capacity 3 to 12mm), die handle with adjustment screw (capacity 3 to 12mm), screw pitch gauge



TTTD34 Tap & Die Set

34 piece tap and die set containing 7 taps, 7 dies, pitch gauge, 7 drill bits, 5 screw extractors, one mini screwdriver, adaptor, mini palm ratchet, interchangeable die chuck and two tap chucks. Supplied in the unique Teng Tools double TC tray with removable lid and dove tail joints for use on it's own or as part of the Teng Tools TC control system. (265x284x50mm, 1.6 kilos)

Metric dies	mm	3x0.5, 4x0.7, 5x0.8, 6x1.0, 8x1.25, 10x1.5, 12x1.75
Metric taps	mm	3, 4, 5, 6, 8, 10, 12mm
Drill bits	mm	2.5, 3.3, 4.2, 5.0, 6.8, 8.5, 10.5mm
Screw extractors	1/8" 3/16" 15/64" 5/16" 3/8"	
Accessories		Screw pitch gauge, mini screwdriver hex (2.5x40mm), 1/4" extension bar, 3/8" F:1/4" M adaptor, 1/4" mini palm ratchet, 1/4" interchangeable die chuck, 1/4" tap chuck (x2 - M3-M8, M5-M12)



TTTC06 Pipe Cutters

6 piece set with pipe cutters for plastic, copper and brass pipes together with a deburring tool. Supplied in the unique Teng Tools TC tray with removable lid and dove tail joints for use on it's own or as part of the Teng Tools TC control system. (265x142x50mm, 1.3 kilos).

Pipe cutters	capacity (mm)	10, 12, 15, 22
Adjustable pipe cutters	capacity (mm)	3-22
Deburring tool	DET01	



TTTCM05D Measuring Set

5 piece general measuring set containing 150mm digital vernier caliper, micrometer 0-25 mm, square 150x100mm, steel rule 150mm and a 135 mm scribe with tungsten carbide tip. Supplied in the unique Teng Tools TC tray with removable lid and dove tail joints for use on it's own or as part of the Teng Tools TC control system. (265x142x50mm, 0.9 kilos)

Digital caliper	mm/inch	150/6"
Micrometer	mm	0/25
Precision square	mm	150 x 100
Steel rule	mm/inch	150/6"
Scriber TC tipped		135



EVERY SECOND COUNTS

POLE POSITION ACCORDING TO TENG



Get organised™



Tool Kits with EVA Control System



TED1489 1/4" Drive Socket Set

Set containing 1/4" drive regular and deep sockets and a comprehensive range of accessories. Supplied in the unique Teng Tools double width TC tray with removable lid and dove tail joints for use on it's own or as part of the Teng Tools TC control system. The tools are held in place using the Teng Tools three colour pre-cut EVA foam tool control system. (265x284x50mm, 1.59 kilos)

Accessories	1/4" drive	72 teeth ratchet, spinner handle, 2" and 4" extension bars, universal joint, coupler adaptor, 3/8"F:1/4"M adaptor, 1/4" M:1/4" hex adaptor
Regular sockets	1/4" drive 6 point	4, 5, 5.5, 6, 7, 8, 9, 10, 11, 12, 13mm
Deep sockets	1/4" drive 6 point	4, 5, 5.5, 6, 7, 8, 9, 10, 11, 13mm
Bit sockets	1/4" drive	4, 5.5, 7mm flat, TX10, TX15, TX20, TX25, TX27, TX30, TX40, PZ1, PZ2, PZ3, PH0, PH1, PH2, PH3
25mm bits	1/4" hex drive	3, 4, 5.5, 7mm flat, TX8, TX10, TX15, TX20, TX25, TX27, TX30, TX40, TX45, PZ0, PZ1, PZ2, PZ3, PH0, PH1, PH2, PH3, PH4, 3, 4, 5, 6, 8, 10mm hex, 1/8", 9/64", 5/32", 3/16", 1/4", 5/16" hex, TPX10, TPX15, TPX20, TPX25, TPX27, TPX30, TPX40, XZN 5 and 6.



TED3836 3/8" Drive Socket Set

Set containing 3/8" drive regular and bit sockets and a range of accessories. Supplied in the unique Teng Tools double width TC tray with removable lid and dove tail joints for use on it's own or as part of the Teng Tools TC control system. The tools are held in place using the Teng Tools three colour pre-cut EVA foam tool control system. (265x284x50mm, 2.49 kilos)

Accessories	3/8" drive	72 teeth ratchet, rotating spinner handle, 3" wobble extension bar, universal joint, 1/2"F:3/8"M adaptor
Regular sockets	3/8" drive 6 point	8, 9, 10, 11, 12, 13, 14, 15, 16, 17, 18, 19, 22mm
Bit sockets	3/8" drive	TX10, TX15, TX20, TX25, TX27, TX30, TX40, TX45, TX50, 3, 4, 5, 5.5, 6, 7, 8, 10, 12mm hex



TED1227 1/2" Drive Socket Set

Set containing 1/2" drive regular and deep 12 point sockets and a range of accessories. Supplied in the unique Teng Tools double width TC tray with removable lid and dove tail joints for use on it's own or as part of the Teng Tools TC control system. The tools are held in place using the Teng Tools three colour pre-cut EVA foam tool control system. (265x284x50mm, 3.59 kilos)

Accessories	1/2" drive	72 teeth ratchet, 2 1/2" and 6" extension bars, universal joint, 3/8"F:1/2"M adaptor
Regular sockets	1/2" drive 12 point	10, 11, 12, 13, 14, 15, 16, 17, 18, 19, 22, 24mm
Deep sockets	1/2" drive 12 point	10, 11, 12, 13, 14, 15, 16, 17, 18, 19mm

TEXTB05 T bar Spark Plug Socket Set NEW!

5 piece T bar spark plug socket set supplied in the unique Teng Tools drawer width TTX tray for use on it's own or as part of the Teng Tools TC control system. The tools are held in place using the Teng Tools three colour pre-cut EVA foam tool control system. (570x115x40mm, 1.4 kilos)



Accessories	T bar handle and T bar handle adaptor
520mm long T bar spark plug sockets	14, 16, 21mm

Tool Kits with EVA Control System

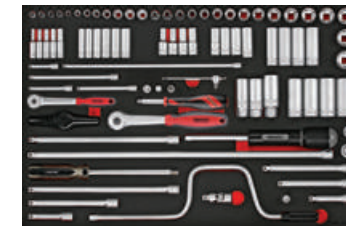

TTESK86 1/4" & 3/8" drive socket set

Set containing 1/4" and 3/8" drive regular and deep metric sockets and a comprehensive range of accessories. Supplied in the Teng Tools three colour pre-cut EVA foam tool control system. (570x375x75mm, 6.55 kilos)

Accessories	1/4" drive	72 teeth ratchet, 6" spinner handle, 2" 3" 4" 6" and 12" extension bars, universal joint, 1/4"F:3/8"M adaptor, sliding T bar, coupler adaptor, T-HD T bar handle adaptor
Regular sockets	1/4" drive 6 point	4, 4.5, 5, 5.5, 6, 7, 8, 9, 10, 11, 12, 13mm
Deep sockets	1/4" drive 6 point	4, 5, 5.5, 6, 7, 8, 9, 10, 11, 12, 13mm
Accessories	3/8" drive	72 teeth ratchet, speed brace, spinner handle, 3", 5", 6", 10" and 20" extension bars, universal joint, 3/8"F:1/4"M adaptor, 3/8"F:1/2"M adaptor, 16mm, 18mm and 21mm spark plug sockets, coupler adaptor, 10" rotating spinner handle.
Regular sockets	3/8" drive 6 point	7, 8, 9, 10, 11, 12, 13, 14, 15, 16, 17, 18, 19, 20, 21 and 22mm
Deep sockets	3/8" drive 6 point	7, 8, 9, 10, 11, 12, 13, 14, 15, 16, 17, 18, 19, 20, 21 and 22mm



TTESK63 1/2" drive socket set

Set containing 1/2" drive regular and deep metric sockets and a comprehensive range of accessories. Supplied in the Teng Tools three colour pre-cut EVA foam tool control system. (570x375x75mm, 11.03 kilos)

Accessories	1/2" drive	72 teeth ratchet, speed brace, sliding T bar, 2 1/2" 5" 6" and 20" extension bars, 3" 6" and 10" wobble extension bars, universal joint, 1/2"F:3/8"M T bar adaptor, 1/2"F:3/4"M adaptor, 16mm, 18mm, 21mm spark plug sockets, coupler adaptors for 5/16", 10mm and 12mm hex bits, flex head adaptor
Regular sockets	1/2" drive 12 point	8, 9, 10, 11, 12, 13, 14, 15, 16, 17, 18, 19, 20, 21, 22, 24, 25, 26, 27, 28, 29, 30, 32, 34mm
Deep sockets	1/2" drive 12 point	10, 11, 12, 13, 14, 15, 16, 17, 18, 19, 20, 21, 22, 24, 27, 30, 32, 36mm

TTESK77 1/4" 3/8" 1/2" drive socket set

76 piece 1/4", 3/8" and 1/2" drive socket set containing 1/4", 3/8" and 1/2" drive sockets and accessories. Covers all the popular sizes from 4 to 24mm with selected sizes in deep and a range of 1/2" drive impact sockets. Supplied in the Teng Tools three colour pre-cut EVA foam tool control system. (570x375x75mm, 7.2 kilos)

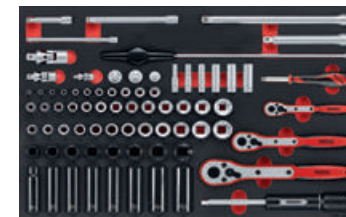

Accessories	1/4" drive	FRP ratchet, 6" spinner handle, 6" and 12" extension bars, universal joint, T-bar and T-bar handle adaptor.
Regular Sockets	1/4" drive 6 point	4, 5, 5.5, 6, 7, 8, 9, 10, 11, 12, 13mm
Deep Sockets	1/4" drive 6 point	7, 8, 10, 12, 13mm
Accessories	3/8" drive	FRP ratchet, 3" wobble extension bar, 6" extension bar, universal joint, 3/8" F:1/4" M adaptor, 3/8" F:1/2" M adaptor, rotating spinner handle.
Regular Sockets	3/8" drive 6 point	8, 9, 10, 11, 12, 13, 14, 15, 16, 17, 18, 19, 22mm.
Accessories	1/2" drive	FRP ratchet, 6" wobble extension bar, 10" extension bar, universal joint, 1/2" F:3/8" M adaptor.
Regular Sockets	1/2" drive 6 point	10, 11, 12, 13, 14, 15, 16, 17, 18, 19, 22mm
Impact Sockets	1/2" drive regular 6 point	13, 15, 16, 17, 18, 19, 22, 24mm
Impact Sockets	1/2" drive deep 6 point	13, 15, 16, 17, 18, 19, 22, 24mm

TEXEXT13 Socket Accessories Set

13 piece extension and socket accessory set. Supplied in the unique Teng Tools drawer width TTX tray for use on it's own or as part of the Teng Tools TC control system. The tools are held in place using the Teng Tools three colour pre-cut EVA foam tool control system. (570x115x40mm, 2.20 kilos)



Accessories	1/4" drive	6" and 12" extension bars, universal joint
	3/8" drive	3" wobble extension bar, 20" extension bar, universal joint, 3/8" F:1/4" M T bar adaptor
	1/2" drive	3" wobble extension bar, 20" extension bar, universal joint
Accessories		T handle grip, 2 and 2.5mm mini hex drivers

Tool Kits with EVA Control System

TTESK85 85 Piece 1/4" 3/8" 1/2" drive socket set

85 piece socket bit set containing 1/4", 3/8" and 1/2" drive bit sockets. Covers all the popular types and sizes including screwdriver type, hex bits, TX and TPX, Ribe and Spline. Supplied in the Teng Tools three colour pre-cut EVA foam tool control system. (570x375x50mm, 4.5 kilos)



Flat bit sockets 1/4" drive 4, 5.5, 7mm	PH bit sockets 1/4" drive PH0, PH1, PH2, PH3
PZ bit sockets 1/4" drive PZ1, PZ2, PZ3	TX-E sockets 1/4" drive E4, E5, E6, E7, E8
TX bit sockets 1/4" drive TX10, TX15, TX20, TX25, TX27, TX30, TX40	Accessories 3/8" drive 3" extension bar
TX-E sockets 3/8" drive E10, E12, E14, E16, E18	TX bit sockets 3/8" drive TX10, TX15, TX20, TX25, TX27, TX30, TX40, TX45, TX50
TPX bit sockets 3/8" drive TPX10, TPX15, TPX20, TPX25, TPX27, TPX30, TPX40, TPX45, TPX50	Hex bit sockets 1/2" drive 3, 4, 5.5, 6, 7, 8, 10, 12mm
TX bit sockets 1/2" drive TX20, TX25, TX27, TX30, TX40, TX45, TX50, TX55, TX60	Hex bit sockets 1/2" drive 5, 6, 7, 8, 10, 12mm
Ribe bit sockets 1/2" drive 4, 5, 6, 8, 10, 11, 12, 13	XZN bit sockets 1/2" drive 5, 6, 8, 10, 12, 14, 16

TEX3403 3/4" Drive Ratchet and Accessories **NEW!**

3 piece 3/4" drive set containing a 72 teeth ratchet handle with quick release and twist reverse together with a 16" extension bar and sliding T bar, supplied in the unique Teng Tools drawer width TTX tray for use on it's own or as part of the Teng Tools TC control system. The tools are held in place using the Teng Tools three colour pre-cut EVA foam tool control system. (570x115x70mm, 5.3 kilos)



Accessories	3/4" drive	Quick release ratchet handle, 400mm, extension bar, sliding T bar
-------------	------------	---

TEX3410 3/4" Drive Socket Set **NEW!**

10 piece set containing 6 point metric sockets. Chrome vanadium steel. Supplied in the unique Teng Tools drawer width TTX tray for use on it's own or as part of the Teng Tools TC control system. The tools are held in place using the Teng Tools three colour pre-cut EVA foam tool control system. (670x115x74mm, 4.6 kilos)



Regular sockets	3/4" drive	6 point	22, 24, 27, 30, 32, 36, 38, 41, 46, 50mm
-----------------	------------	---------	--

TTESK32 3/4" drive socket set

Set containing 3/4" drive regular metric and AF sockets together with a 72 teeth ratchet, extension bar, sliding T bar and flex handle - all with safety locking mechanism to hold sockets on tightly. Supplied in the Teng Tools three colour pre-cut EVA foam tool control system. (570x375x75mm, 17.27 kilos)

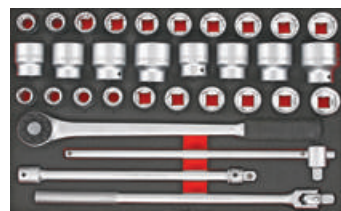

Accessories	3/4" drive	72 teeth ratchet, sliding T bar, 16" extension bar, 19" flex handle - all accessories with safety locking.		
Regular sockets	3/4" drive	6 point	19, 21, 22, 24, 27, 30, 32, 33, 34, 36, 38, 41, 46, 50mm	
Regular sockets	3/4" drive	12 point	3/8", 7/16", 1", 1 1/8", 1 1/4", 1 3/8", 1 1/2", 1 5/8", 1 3/4", 1 7/8", 1 1/2", 1 5/8", 1 3/4", 1 7/8"	

TED9121 1/2" Drive Impact Socket Set

Set containing 1/2" drive regular and deep ANSI standard 6 point impact sockets and a range of accessories. Supplied in the unique Teng Tools double width TC tray with removable lid and dove tail joints for use on it's own or as part of the Teng Tools TC control system. The tools are held in place using the Teng Tools three colour pre-cut EVA foam tool control system. (265x284x50mm, 4.18 kilos)



Accessories	1/2" drive	3" and 10" extension bars, universal joint, 3/8" F:1/2" M Adaptor, 1/2" F:3/4" M adaptor		
Regular sockets	1/2" drive	6 point	13, 15, 16, 17, 18, 19, 22, 24mm	
Deep sockets	1/2" drive	6 point	13, 15, 16, 17, 18, 19, 22, 24mm	

Tool Kits with EVA Control System

TTEISK73 3/8" & 1/2" drive Impact socket set

Set containing 3/8" and 1/2" drive regular and deep metric impact sockets and a comprehensive range of accessories. Supplied in the Teng Tools three colour pre-cut EVA foam tool control system. (570x375x75mm, 12.34 kilos)

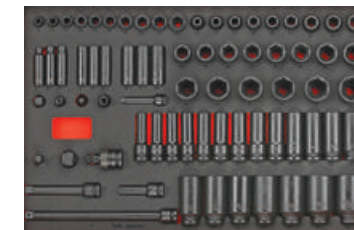

Accessories	3/8" drive	3" extension bar, 3/8" F:1/4" M adaptor, 3/8" F:1/2" M adaptor, coupler adaptor for 1/4" hex bits		
Regular impact sockets	3/8" drive	6 point	8, 10, 11, 12, 13, 14, 15, 16, 17, 18, 19mm	
Deep impact sockets	3/8" drive	6 point	8, 10, 11, 12, 13, 14, 16, 17, 19mm	
Accessories	1/2" drive	3", 5" and 10" extension bars, universal joint, 1/2" F:3/8" M adaptor, 1/2" F:3/4" M adaptor, coupler adaptor for 5/16" hex bits		
Regular impact sockets	1/2" drive	6 point	8, 10, 11, 12, 13, 14, 15, 16, 17, 18, 19, 20, 21, 22, 23, 24, 25, 26, 27, 28, 29, 30, 32mm	
Deep impact sockets	1/2" drive	6 point	10, 11, 12, 13, 14, 15, 16, 17, 18, 19, 21, 22, 24, 27, 28, 29, 30, 32, 35, 36mm	

TTEISK33 3/4" drive impact socket set

Set containing 3/4" drive regular and deep metric impact sockets and a comprehensive range of accessories. Supplied in the Teng Tools three colour pre-cut EVA foam tool control system. (570x375x75mm, 20.92 kilos)



Accessories	3/4" drive	7" extension bar, universal joint, 3/4" F:1/2" M adaptor, 3/4" F:1" M adaptor		
Regular impact sockets	3/4" drive	6 point	19, 21, 22, 23, 24, 27, 28, 30, 32, 33, 34, 36, 38, 41, 46mm	
Deep impact sockets	3/4" drive	6 point	19, 21, 22, 23, 24, 27, 30, 32, 33, 34, 36, 38, 41, 46mm	

TED8012 Anti Slip Combination Spanner Set

12 piece metric combination spanner set featuring a typically Teng new design in combination spanners that gives an anti slip grip on the open end as well as the Teng Tools hip grip function where the spanner drives on the flank of the fastening rather than the corner, two design features that combine to give a much better grip with much less risk of damage to the fastening. The design also gives grip on fastenings with worn or rounded corners. Supplied in the unique Teng Tools double width TC tray with removable lid and dove tail joints for use on it's own or as part of the Teng Tools TC control system. The tools are held in place using the Teng Tools three colour pre-cut EVA foam tool control system. (265x284x50mm, 1.50 kilos)



Combination spanners	8, 9, 10, 11, 12, 13, 14, 15, 16, 17, 18, 19mm
----------------------	--

TED6515 Combination Spanner Set

15 piece metric combination spanner set covering 5.5 to 19mm. Supplied in the unique Teng Tools double width TC tray with removable lid and dove tail joints for use on it's own or as part of the Teng Tools TC control system. The tools are held in place using the Teng Tools three colour pre-cut EVA foam tool control system. (265x284x50mm, 1.61 kilos)



Combination spanners	5.5, 6, 7, 8, 9, 10, 11, 12, 13, 14, 15, 16, 17, 18, 19mm
----------------------	---

Tool Kits with EVA Control System

TEX2032 Combination Spanner Set

7 piece metric combination spanner set covering 20 to 32mm. Supplied in the unique Teng Tools drawer width TTX tray for use on it's own or as part of the Teng Tools TC control system. The tools are held in place using the Teng Tools three colour pre-cut EVA foam tool control system. (570x115x60mm, 2.77 kilos)



Combination spanners 20, 21, 22, 24, 27, 30, 32mm

TED6512R Ratcheting Combination Spanner Set

12 piece set of metric ratcheting combination spanners with flip reverse. Supplied in the unique Teng Tools double width TC tray with removable lid and dove tail joints for use on it's own or as part of the Teng Tools TC control system. The tools are held in place using the Teng Tools three colour pre-cut EVA foam tool control system. (265x284x50mm, 1.83 kilos)



Ratcheting combination spanners 8, 9, 10, 11, 12, 13, 14, 15, 16, 17, 18, 19mm

TED6512RS Ratcheting Combination Spanner Set

12 piece set of metric ratcheting combination spanners. Supplied in the unique Teng Tools double width TC tray with removable lid and dove tail joints for use on it's own or as part of the Teng Tools TC control system. The tools are held in place using the Teng Tools three colour pre-cut EVA foam tool control system. (265x284x50mm, 1.91 kilos)



Ratcheting combination spanners 8, 9, 10, 11, 12, 13, 14, 15, 16, 17, 18, 19mm

TEX6308 Double Ring Spanner Set **NEW!**

8 piece double ring spanner set supplied in the unique Teng Tools drawer width TTX tray for use on it's own or as part of the Teng Tools TC control system. The tools are held in place using the Teng Tools three colour pre-cut EVA foam tool control system (570x115x60mm, 1.2 kilos)



Double ring spanners 6x7, 8x9, 10x11, 12x13, 14x15, 16x17, 18x19, 20x22mm

TEXFLS06 Extra Long Double Ring Spanner Set **NEW!**

6 piece extra long double ring spanner set supplied in the unique Teng Tools drawer width TTX tray for use on it's own or as part of the Teng Tools TC control system. The tools are held in place using the Teng Tools three colour pre-cut EVA foam tool control system. (570x115x70mm, 1.2 kilos)



Double ring spanners 8x10, 11x13, 12x14, 16x18, 17x19, 22x24mm

Tool Kits with EVA Control System

TTESP31 Metric combination spanner set

Set containing metric combination spanners covering 5.5mm to 38mm. Supplied in the Teng Tools three colour pre-cut EVA foam tool control system. (570x375x75mm, 8.47 kilos)

Combination spanners 5.5, 6, 7, 8, 9, 10, 11, 12, 13, 14, 15, 16, 17, 18, 19, 20, 21, 22, 23, 24, 25, 26, 27, 28, 29, 30, 32, 33, 34, 36, 38mm



TTESP37 Metric spanner set

Set containing metric ratcheting combination spanners, metric double open ended spanners and double ring spanners. Supplied in the Teng Tools three colour pre-cut EVA foam tool control system. (570x375x75mm, 7.62 kilos)

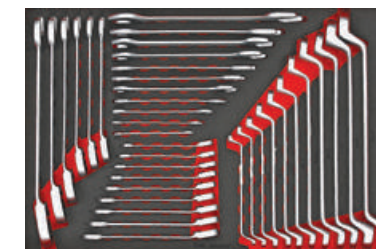

Ratcheting combination spanners 8, 9, 10, 11, 12, 13, 14, 15, 16, 17, 18, 19, 22, 24, 27mm
 Double open ended spanners 6x7, 8x9, 10x11, 12x13, 14x15, 16x17, 18x19, 20x22, 21x23, 24x27, 30x32mm
 Double ring spanners 6x7, 8x9, 10x11, 12x13, 14x15, 16x17, 18x19, 20x22, 21x23, 24x27, 30x32mm

TTEAF62 AF socket & spanner set

Set containing AF combination spanners and socketry covering 3/16" to 1 1/4". Supplied in the Teng Tools three colour pre-cut EVA foam tool control system. (570x375x75mm, 5.9 kilos)



Combination spanners	inch		5/16"	3/8"	7/16"	1/2"	9/16"	5/8"	11/16"	3/4"	13/16"	7/8"	15/16"	1"	1 1/8"	1 1/4"
Regular sockets	1/4" drive	6 point	3/16"	7/32"	1/4"	9/32"	5/16"	11/32"	3/8"	7/16"	1/2"					
Deep sockets	1/4" drive	6 point	3/16"	7/32"	1/4"	9/32"	5/16"	11/32"	3/8"	7/16"	1/2"					
Regular sockets	3/8" drive	6 point	3/8"	7/16"	1/2"	9/16"	5/8"	11/16"	3/4"							
Deep sockets	3/8" drive	6 point	3/8"	7/16"	1/2"	9/16"	5/8"	11/16"	3/4"							
Regular sockets	1/2" drive	12 point	3/8"	7/16"	1/2"	9/16"	5/8"	11/16"	3/4"	13/16"	7/8"	15/16"	1"	1 1/8"	1 1/4"	

TTEX32 32 piece spanner and file set

Set containing a complete range of combination spanners, ratcheting combination spanners and engineers files. Supplied in the Teng Tools three colour pre-cut EVA foam tool control system. (570x375x50mm, 5.65 kilos)



Combination spanners 8, 9, 10, 11, 12, 13, 14, 15, 16, 17, 18, 19, 20, 21, 22, 24, 27, 30, 32mm
 Ratcheting combination spanners 8, 10, 11, 12, 13, 14, 17, 19mm
 10" engineers files flat, round, half round, three square and hand type flat

TEDHEX7 T handle Hex Key Set

7 piece set of T handle hex keys with ball point ends on the long key end. Supplied in the unique Teng Tools double width TC tray with removable lid and dove tail joints for use on it's own or as part of the Teng Tools TC control system. The tools are held in place using the Teng Tools three colour pre-cut EVA foam tool control system. (265x284x50mm, 1.11 kilos)



T handle hex keys	2.5, 3, 4, 5, 6, 7, 8mm
-------------------	-------------------------

TEDTX7 T handle TX Key Set

7 piece set of T handle TX keys with TPX ends on the long key end. Supplied in the unique Teng Tools double width TC tray with removable lid and dove tail joints for use on it's own or as part of the Teng Tools TC control system. The tools are held in place using the Teng Tools three colour pre-cut EVA foam tool control system. (265x284x50mm, 0.98 kilos)



T handle TX keys	TX10, TX15, TX20, TX25, TX27, TX30, TX40
------------------	--

TEDSD95 Torque Screwdriver, Impact Driver and Bit Set

1/4" drive 1-5Nm torque screwdriver and 1/2" drive impact driver together with assorted bits to suit most types of fastenings. Supplied in the unique Teng Tools double width TC tray with removable lid and dove tail joints for use on it's own or as part of the Teng Tools TC control system. The tools are held in place using the Teng Tools three colour pre-cut EVA foam tool control system. (265x284x50mm, 2.40 kilos)



Accessories	1/4" drive	1-5Nm torque screwdriver, quick release chuck, sliding T bar, 6" flexible extension, Ratcheting bits driver with assorted bits in the handle (5, 7mm flat, PH1, PH2, PZ1, PZ2, 1/4"M:1/4" hex adaptor)
	3/8" drive	3/8"M:5/16" hex adaptor
	1/2" drive	impact driver, 5/16" hex bit adaptor
5/16" hex 36mm bits	flat type	1.4x6, 1.4x8, 2.2x10, 1.8x12mm
	PH	PH1, PH2, PH3, PH4
	hex	4, 5, 6, 8mm
	TX	TX30, TX40, TX45, TX50, TX55
1/4" hex 25mm bits	flat type	0.6x3.5, 0.6x4.5, 0.8x4.0, 0.8x5.5, 1.0x5.5, 1.2x6.5, 1.6x8.0mm
	PH	PH1 (x3), PH2 (x6), PH3
	PZ	PZ1 (x3), PZ2 (x6), PZ3
	hex	2, 3, 4, 5, 6, 8mm
	TX	TX6, TX7, TX8, TX9, TX10, TX15, TX20 (x3), TX25 (x3), TX27, TX30, TX40
	TPX	TPX10, TPX15, TPX20 (x2), TPX25 (x2), TPX27, TPX30, TPX40
	Square	1, 2, 3
	GR	2 (x3)

TEX1238 Torque Wrench Set

1/2" drive and 3/8" drive angular gauge torque wrenches covering 20-210Nm (15-150 ft/lb) in total. Supplied in the unique Teng Tools drawer width TTX tray for use on it's own or as part of the Teng Tools TC control system. The tools are held in place using the Teng Tools three colour pre-cut EVA foam tool control system. (570x115x60mm, 2.77 kilos)



Torque wrench	3/8" drive	20-110Nm (15-81ft/lb)
	1/2" drive	40-210Nm (30-150 ft/lb)

TEXMP12 Torque Multiplier Set **NEW!**

A 1292AG-EP 1/2" drive tested and certified 210Nm torque wrench together with an MP1400 torque multiplier that converts the torque at a ratio of 3:1 up to a maximum capacity of 1500Nm with a 3/4" male square drive. Supplied in the unique Teng Tools drawer width TTX tray for use on it's own or as part of the Teng Tools TC control system. The tools are held in place using the Teng Tools three colour pre-cut EVA foam tool control system. (570x115x60mm, 4.6 kilos)



TTorque wrench	1/2" drive angular gauge covering 40 to 210Nm (1292AG-EP)
Torque multiplier	1/2"F:3/4"M torque multiplier (3 to 1 ratio) and maximum torque capacity 1500Nm (MP1400)

TEDHT42 Hex and TX wrench Set

A comprehensive set of hex and TX keys and wrenches. Supplied in the unique Teng Tools double width TC tray with removable lid and dove tail joints for use on it's own or as part of the Teng Tools TC control system. The tools are held in place using the Teng Tools three colour pre-cut EVA foam tool control system. (265x284x50mm, 1.75 kilos)



Hex key sets	metric	1.5, 2, 2.5, 3, 4, 5, 6, 8, 10 and 7mm
	inch	5/64", 3/32", 1/8", 5/32", 3/16", 7/32", 1/4", 5/16", 3/8"
TX key set	TX	8, 9, 10, 15, 20, 25, 27, 30, 40
Fold up set		4, 5, 6mm hex, TX25, TX30, 1.0x5.5 flat, PH2, PZ2
Mini TX keys	TX	6, 7, 8, 9, 10, 15

TEDADJ4 Adjustable wrench Set

4 piece adjustable wrench set. Supplied in the unique Teng Tools double width TC tray with removable lid and dove tail joints for use on it's own or as part of the Teng Tools TC control system. The tools are held in place using the Teng Tools three colour pre-cut EVA foam tool control system. (265x284x50mm, 1.58 kilos)



Adjustable wrenches	6" (150mm), 8" (200mm), 10" (250mm)
Wide jaw adjustable wrench	8" (200mm)

TTEX17

17 piece hexagon key, torque wrench and inspection tool set

Set containing a 1/2" drive torque wrench, hexagon keys and wrenches and selection of inspection tools. Supplied in the Teng Tools three colour pre-cut EVA foam tool control system. (570x375x50mm, 3.3 kilos)



Torque wrench	1/2" drive	40-200Nm range with built in angular gauge, individually tested and certified at the time of manufacture
T handle hex keys	2.5, 3, 4, 5, 6, 7, 8mm	
Mixed fold up key set	4, 5, 6mm hex, TX25, TX30, 5.5mm flat, PH1, PZ2	
Ball point hex keys	1.5, 2, 2.5, 3, 4, 5, 6, 7, 8, 10mm	
TX keys	TX8, TX9, TX10, TX15, TX20, TX25, TX27, TX30, TX40	
Inspection tools	Magnetic pick up, magnifying glass, 57cm diameter mirror (all telescopic with extension up to 85cm), pocket sized LED torch	Hook and pick set
pick up tools	Aluminium handle with interchangeable awl, hook tool, 45° and 90°	

TTEX23 Wrenches set

Set containing metric T handle nut drivers and metric hex and TX/TPX T handle drivers. Supplied in the Teng Tools three colour pre-cut EVA foam tool control system. (570x375x50mm, 2.47 kilos)

Nut drivers	5, 5.5, 6, 7, 8, 10, 11, 12, 13mm
T handle hex drivers	2.5, 3, 4, 5, 6, 7, 8mm
T handle TX/TPX drivers	T10, T15, T20, T25, T27, T30, T40

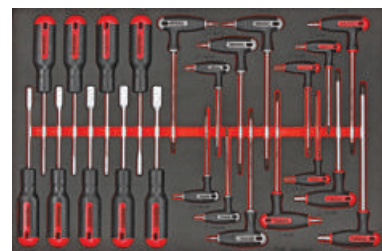

TED911N Screwdriver Set

11 piece screwdriver set. Supplied in the unique Teng Tools double width TC tray with removable lid and dove tail joints for use on it's own or as part of the Teng Tools TC control system. The tools are held in place using the Teng Tools three colour pre-cut EVA foam tool control system. (265x284x50mm, 1.22 kilos)



Screwdrivers	flat type	round shaft	3.5x100, 5.5x75mm, 6.5x38mm stubby
	flat type	hexagon shaft	5.5x125, 6.5x100mm
Screwdrivers	PH type	round shaft	PH0x75, PH1x75, PH2x38mm stubby
	PH type	hexagon shaft	PH2x100mm
Screwdrivers	PZ type	round shaft	PZ1x75mm
	PZ type	hexagon shaft	PZ2x100mm

TEX915N Screwdriver Set

5 piece screwdriver set. Supplied in the unique Teng Tools drawer width TTX tray for use on it's own or as part of the Teng Tools TC control system. The tools are held in place using the Teng Tools three colour pre-cut EVA foam tool control system. (570x115x40mm, 1.22 kilos)



Screwdrivers	flat type	5.5x150, 6.5x150, 8.0x150, 10.0x200mm
Screwdrivers	PH type	PH3x150mm

TEXMDTN Power Thru Screwdriver Set **NEW!**

5 piece power thru screwdriver set supplied in the unique Teng Tools drawer width TTX tray for use on it's own or as part of the Teng Tools TC control system. The tools are held in place using the Teng Tools three colour pre-cut EVA foam tool control system. (570x115x40mm, 1.6 kilos)



Screwdrivers	PH type	PH2 x 100mm, PH3 x 150mm
Screwdrivers	flat type	6.5x100, 8x150, 10x200mm

TED909TXN TX driver Set

9 piece TX driver set. Supplied in the unique Teng Tools double width TC tray with removable lid and dove tail joints for use on it's own or as part of the Teng Tools TC control system. The tools are held in place using the Teng Tools three colour pre-cut EVA foam tool control system. (265x284x50mm, 1.10 kilos)



TX drivers	TX6, TX8, TX9, TX10, TX15, TX20, TX25, TX27, TX30
------------	---

TTEM122N Screwdriver Set

Set containing a comprehensive range of Mega Drive screwdrivers and bits. Supplied in the Teng Tools three colour pre-cut EVA foam tool control system. (570x375x75mm, 3.13 kilos)



Screwdrivers	flat regular	2.5x75mm, 3.5x75mm, 3.0x100mm, 4.0x100mm, 5.5x75mm, 5.5x150mm, 6.5x38mm, 6.5x100mm, 6.5x150mm, 8.0x150mm, 10.0x200mm
Screwdrivers	PH type	PH0x75mm, PH1x38mm, PH1x75mm, PH2x38mm, PH2x100mm, PH3x150mm, PH4x200mm
Screwdrivers	PZ type	PZ0x75mm, PZ1x38mm, PZ1x100mm, PZ2x38mm, PZ2x100mm, PZ2x150mm, PZ3x150mm
Accessories	1/4" hex drive	6 in 1 ratchetting bits driver set, bit holders for 25mm bits
25mm hex bits	1/4" hex drive	0.6x3.5mm, 0.6x4.5mm, 0.8x4.0mm (x2), 0.8x5.5mm (x2), 1.2x6.5mm, 1.6x8.0mm flat, PH1 (x3), PH2 (x3), PH3 (x3), PZ1 (x3), PZ2 (x3), PZ3 (x3), TX6, 7, 8, 9, 10, 15, 20 (x3), 25 (x3), 27, 30, 40, 2, 3, 4, 5, 6, 8mm hex, ROB1, ROB2, ROB3, GR2 (x3), TPX10, 15, 20 (x2), 25 (x2), 27, 30, 40
50mm hex bits	1/4" hex drive	0.6x3.5mm, 0.8x4.0mm, 0.8x5.5mm, 1.0x5.5mm, 1.2x6.5mm flat (3 of each), 4, 5, 6, 8mm (3 of each), PH1, PH2 (x2), PH3, PZ1, PZ2 (x2), PZ3, TX8, 10 (x2), 15, 20 (x2), 25 (x2), 27, 30.

TEDV909N 1,000 Volt Insulated Screwdriver Set

9 piece 1,000 volt insulated screwdriver set. Supplied in the unique Teng Tools double width TC tray with removable lid and dove tail joints for use on it's own or as part of the Teng Tools TC control system. The tools are held in place using the Teng Tools three colour pre-cut EVA foam tool control system. (265x284x50mm, 1.02 kilos)



Screwdrivers	flat type	2.5x75, 3.5x100, 4.0x100, 5.5x125mm
Screwdrivers	PH type	PH0, PH1, PH2
Screwdrivers	PZ type	PZ2
Voltage tester		100-250 volts

TEDV440 1,000 Volt Insulated Plier Set

4 piece 1,000 volt insulated plier set. Supplied in the unique Teng Tools double width TC tray with removable lid and dove tail joints for use on it's own or as part of the Teng Tools TC control system. The tools are held in place using the Teng Tools three colour pre-cut EVA foam tool control system. (265x284x50mm, 1.28 kilos)



Pliers	6" side cutters, 8" long nose pliers, 8" combination pliers, 7" wire stripping pliers.
--------	--

TTEMD98N 98 piece screwdriver and bits driver set

Set containing a wide range of screwdrivers covering all types and including a range of 1,000 volt insulated screwdrivers (produced and tested according to the EN60900 standard. Approved for working up to 1,000 volt AC). Supplied in the Teng Tools three colour pre-cut EVA foam tool control system. (570x375x50mm, 2.83 kilos)



Screwdrivers	TX type	TX8x75, TX9x75mm
Screwdrivers	TPX type	TPX10x100, TPX15x100, TPX20x100, TPX25x100, TPX30x100mm
Power thru screwdrivers	flat type	6.5x100, 8x150, 10x200mm
Power thru screwdrivers	PH type	PH2x100, PH3x150mm
1,000 volt screwdrivers	flat type	2.5x75, 4x100, 5.5x125mm
1,000 volt screwdrivers	PH type	PH0x60, PH1x8, PH2x100mm
1,000 volt screwdrivers	PZ type	PZ2x100mm
Mini screwdrivers	flat type	2.0x40, 2.5x40, 3.0x40mm
Mini screwdrivers	PH type	PH00x40, PH0x40, PH1x40mm
Mini screwdrivers	TX type	TX6, TX7, TX8, TX9, TX10, TX15
1/4" hex 25mm screwdriver bits	flat type	0.6x3.5, 0.6x4.5, 0.8x4.0(2pieces), 0.8x5.5, 1.0x5.5(2 pieces), 1.2x6.5, 1.6x8.0mm
1/4" hex 25mm screwdriver bits	GR type	PH2 (3 pieces)
1/4" hex 25mm screwdriver bits	Hex type	2, 3, 4, 5, 6, 8mm
1/4" hex 25mm screwdriver bits	PH type	PH1 (3 pieces), PH2 (3 pieces), PH3 (3 pieces),
1/4" hex 25mm screwdriver bits	PZ type	PZ1 (3 pieces), PZ2 (3 pieces), PZ3 (4 pieces)
1/4" hex 25mm screwdriver bits	ROB type	1,2,3 square
1/4" hex 25mm screwdriver bits	TX type	TX6, TX7, TX8, TX10, TX15, TX20 (3 pieces), TX25 (3 pieces), TX27, TX30, TX40
1/4" hex 25mm screwdriver bits	TPX type	TPX10, TPX15, TPX20 (2 pieces), TPX25 (2 pieces), TPX27, TPX30, TPX40
Ratchetting bits driver	Reversible for use with 1/4" hexagon drive bits. Supplied with 6 assorted bits stored in slide out holder in the handle	
Accessories	Magnetic charger and discharger for magnetising and/or demagnetising screwdriver tips, "bullet holders" for bits	
Accessories	1/4" drive	1/4"M:1/4" hexagon adaptor, coupler adaptor



Pliers	5" side cutters, 6" heavy duty side cutters, 8" long nose pliers, 8" heavy duty combination pliers, 10" water pump pliers.
--------	--

TEXMB02 Water Pump Pliers & Alligator Adjustable Wrench Set NEW!

Two really handy tools in one TTX Tray for use on it's own or as part of the Teng Tools TC control system. The set includes the MB482-10Q quick adjustable water pump plier and the 4003J 10" "Alligator" adjustable wrench with pipe grip. The tools are held in place using the Teng Tools three colour pre-cut EVA foam tool control system. (570x115x40mm, 0.97 kilos)



Wrenches	10" "Alligator" adjustable
Pliers	10" quick action water pump

TTEMB17 Plier set

Set containing 17 assorted Mega Bite pliers. Supplied in the Teng Tools three colour pre-cut EVA foam tool control system. (570x375x50mm, 4.25 kilos)

Cutting pliers	5" side cutters, 6" side cutters, 6" heavy duty side cutters, 8" heavy duty side cutters, 8" offset heavy duty side cutters, 8" cable cutters
Combination pliers	7" heavy duty combination, 8" heavy duty combination
Long nose pliers	8" long nose, 6" flat long nose
Circlip pliers	7" inner/straight, 7" inner/bent, 7" outer/straight, 7" outer/bent
Water pump pliers	7" water pump, 10" water pump
Wire strippers	7" wire stripping pliers



TTEMB11 11 piece plier set

Set containing a range of the most commonly used pliers and power grip pliers. Supplied in the Teng Tools three colour pre-cut EVA foam tool control system. (570x375x75mm, 3.3 kilos)

Side cutters	Heavy duty	8"(3.0mm piano wire cutting capacity)
Combination pliers	High leverage	7"(1.8mm piano wire cutting capacity)
Long nose pliers		8" (1.5mm piano wire cutting capacity)
Water pump pliers		10" (38mm capacity)
Circlip pliers	Inner type	7" straight and bent type (1.8mm tip, 19 to 60mm capacity)
Circlip pliers	outer type	7" straight and bent type (1.8mm tip, 19 to 60mm capacity)
Power grip pliers	long nose	6" straight jaw (35mm capacity)
Power grip pliers	regular	4" and 10" curved jaw (25mm/47mm capacity)



TTEVG11 Power grip plier set

Set containing 11 assorted power grip pliers. Supplied in the Teng Tools three colour pre-cut EVA foam tool control system. (570x375x50mm, 5.17 kilos)

Round jaw type	4", 5", 10" and 12"
Flat jaw type	10" and 12"
Long nose type	4", 6 1/2" and 9"
Clamp pliers	11" C clamp plier with swivel pad, 12" self levelling locking plier



TEDPC14 Punch and Chisel Set

14 piece set including parallel pin punches, centre punch and cold chisels. Supplied in the unique Teng Tools double width TC tray with removable lid and dove tail joints for use on it's own or as part of the Teng Tools TC control system. The tools are held in place using the Teng Tools three colour pre-cut EVA foam tool control system. (265x284x50mm, 2.71 kilos)



150mm parallel pin punches	3, 4, 5, 6, 7, 8mm
Flat chisels	19x150, 25x200, 25x250, 26x240mm
150mm centre punches	4, 5, 8mm, automatic centre punch

Tool Kits with EVA Control System

TEXW05 Wheel Tools Set

5 piece wheel removal tool set. Supplied in the unique Teng Tools drawer width TTX tray for use on it's own or as part of the Teng Tools TC control system. The tools are held in place using the Teng Tools three colour pre-cut EVA foam tool control system. (570x115x40mm, 2.38 kilos)



Flexible handle	1/2" drive	17" (425mm)
Wheel nut sockets	1/2" drive	17, 19, 21mm
Impact accessories	1/2" drive	5" (125mm) extension bar

TEXPB4 Pry Bar Set

4 piece set including three roll/heel bars and a 20" tyre lever. Supplied in the unique Teng Tools drawer width TTX tray for use on it's own or as part of the Teng Tools TC control system. The tools are held in place using the Teng Tools three colour pre-cut EVA foam tool control system. (570x115x40mm, 2.80 kilos)



Roll/heel bars	12", 16", 20"
Tyre lever	20"

TTEPS12 12 piece general service tools

A set containing general hand tools. Supplied in the Teng Tools three colour pre-cut EVA foam tool control system. (570x375x50mm, 3.34 kilos)



Cutting tools	Utility knife with spare blades, 12" hack saw
Striking tools	800gm engineers hammer, soft face hammer, cold chisels (150x18mm, 200x25mm), 150x5mm centre punch, parallel pin punches (3, 4, 5, 6, 7, 8mm)
Gripping tools	6" and 10" adjustable wrenches
Measuring tools	3 meter measuring tape, 200mm steel rule

EVA-01 Design your own EVA tray

A blank, uncut EVA tray that can be cut manually or at a specialist cutting company to suit your own individual requirements. Alternatively Teng Tools are able to manufacture EVA trays to suit your own individual design – full details are available on request. (570x375x50mm)

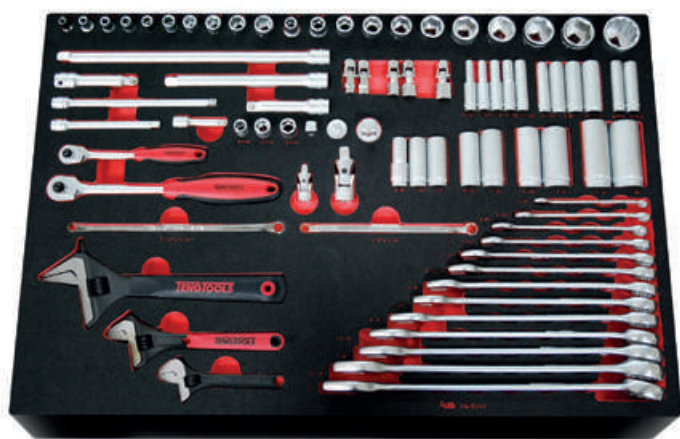

An example of an individually personalised EVA tool tray manufactured to special order.



EVERY SECOND COUNTS

POLE POSITION ACCORDING TO TENG



Get organised™





Work Bench System

The Teng Tools roller cabinet based work bench system has been developed to be extremely flexible enabling you to create a work station that suits your particular needs.

A simple system that uses a relatively small number of different components to enable you to build an endless variety of work station configurations. Simply start with one or more Teng Tools roller cabinets or roller cabinet based tool kits and add work surfaces and back panels to give a working surface and the ability to hang additional tools and accessories using the wide range of Teng Tools hook on or magnetic shelves, hooks and wall racks.

Header Boards

Header boards for use with tool panels when building a work station. Available in three sizes to suit different size panels. Painted sheet metal construction.

Stock no.	Dimensions mm	Suitable for work bench panel
TC-H01	670x60x25x1.2	TC-PA01
TC-H05	950x60x25x1.2	TC-PA03
TC-H02	1,380x65x25x1.2	TC-PA02



Work Bench Work Tops

Work bench work tops manufactured in laminated wood. Available in three sizes to suit different width roller cabinets when used with different size panels.

Stock no.	Dimensions mm	Suitable for work bench panel
TC-TB02	672x460x37	TCW806N, TCW806N1, TCW807N, TCW810N, TCW907X, TCW707EV
TC-TB03	948x155x18	TCW207N
TC-TB01	1,354x462x37	TCW806LN, TCW809N



Work Bench Panels

Tool panels for use when building a work station based on Teng Tools roller cabinets. Available in three sizes to suit different width roller cabinets. Painted sheet metal construction.

Stock no.	Dimensions mm	Suitable for work bench panel
TC-PA01	665x480 25x1.6 25x1.6	TCW806N, TCW806N1, TCW807N, TCW810N, TCW907X, TCW707EV
TC-PA03	944x478x25x1.6	TCW207N
TC-PA02	1,370x480x1.6	TCW806LN, TCW809N

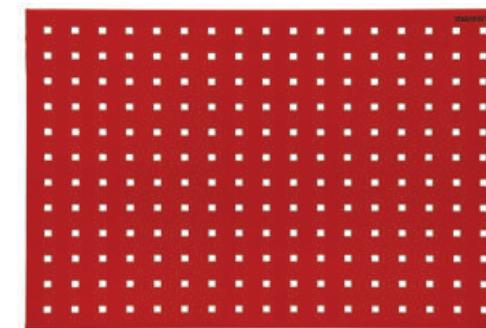

Fixing Bars

Fixing bars for use with tool panels when building a work station. Available in three sizes to suit different size panels.

Stock no.	Dimensions mm	Suitable for work bench panel
TC-FB01	20x30x664	TCW806N, TCW806N1, TCW807N, TCW810N, TCW907X, TCW707EV
TC-FB03	20x30x916	TCW207N
TC-FB02	20x30x1,342x1.2	TCW806LN, TCW809N



L Bracket

An L shaped bracket for mounting a work top to the side of a Teng Tools roller cabinet.

Stock no.	Dimensions mm
TC-LBK	330x150x2.0



Support Leg

A support leg for use when mounting a work top to the side of a Teng Tools roller cabinet. Adjustable feet to give a secure and level add on work surface.

Stock no.	Dimensions mm
TC-LEG	40x80x2.0



Work Bench Upright

Uprights for fixing panels to the Teng Tools roller cabinet when creating a work station. Left and right hand side options.

Stock no.	Dimensions mm	Dimensions mm
TC-UPRR	right hand side	1,100x450x40
TC-UPRL	left hand side	1,100x450x40
TC-UPRRS	right hand side	620x450x40
TC-UPRLS	left hand side	620x450x40



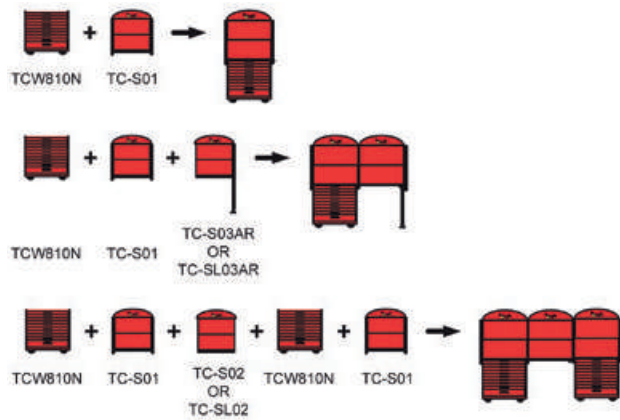

Panel sets

Preconfigured sets for creating work stations based on one or two Teng Tools roller cabinets (any combination of TCW806N, TCW806N1, TCW807N, TCW810N, TCW907X or TCW707EV (the roller cabinets are not included).

Stock No	TC-S01	TC-S02	TC-S03AR Right	TC-S03AL Left
Contents				
Tool panels	2 x TC-PA01	2 x TC-PA01	2 x TC-PA01	2 x TC-PA01
Uprights	1 x TC-UPRR 1 x TC-UPRL		1 x TC-UPRR	1 x TCUPRL
Work tops	1 x TC-TB02	1 x TC-TB02	1 x TC-TB02	1 x TC-TB02
Fixing bars	1 x TC-FB01	1 x TC-FB01	1 x TC-FB01	1 x TC-FB01
Top signs	1 x TC-H01	1 x TC-H01	1 x TC-H01	1 x TC-H01
Brackets		2 x TC-LBK	2 x TC-LBK	2 x TC-LBK
Support legs			1 x TC-LEG	1 x TC-LEG

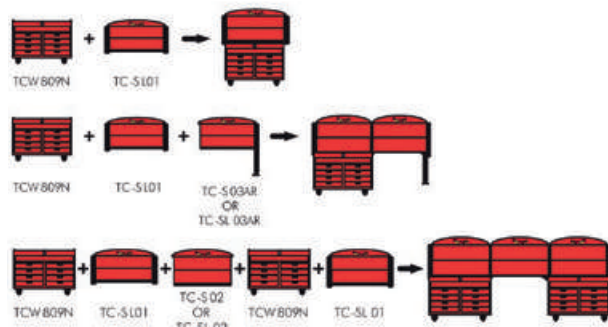

Panel sets

Preconfigured sets for creating work stations based on one or two of the 53" wide Teng Tools roller cabinets (any combination of TCW806LN or TCW809N (the roller cabinets are not included).

Stock No	TC-SL01	TC-SL02	TC-SL03AL Left	TC-SL03AR Right
Contents				
Tool panels	2 x TC-PA02	2 x TC-PA02	2 x TC-PA02	2 x TC-PA02
Uprights	1 x TC-UPRR 1 x TC-UPRL		1 x TC-UPRL	1 x TC-UPRR
Work tops		1 x TC-TB01	1 x TC-TB01	1 x TC-TB01
Fixing bars	1 x TC-FB02	1 x TC-FB02	1 x TC-FB02	1 x TC-FB02
Top signs	1 x TC-H02	1 x TC-H02	1 x TC-H02	1 x TC-H02
Brackets		2 x TC-LBK	2 x TC-LBK	2 x TC-LBK
Support legs			1 x TC-LEG	1 x TC-LEG

Hook on trays for tool panels

Shelves that can be hooked on to the tool panels.

Stock No.	Width mm	Depth mm	Height mm	Weight g
TCT01	230	101	139	431
TCT02	460	101	140	796
TCT03	640	103	141	1,100



Hook on aerosol can holders for tool panels

Shelves that can be hooked on to the tool panels for storing aerosol cans, bottles, etc.

Stock No.	Width mm	Depth mm	Height mm	No. of holes for aerosol	Weight g
TCC01	230	98	136	2	411
TCC02	460	99	137	4	778
TCC03	640	100	138	6	1,093



TCT04 Hook tool holder for tool panels

A hook on holder for T bars, etc. Measures 103.5mm wide, 23.5mm deep and 178mm high. Weight 302g.



587J LED light bar

A 255mm wide light bar with magnetic attachment for use with work bench panels or tool boxes. 9 white LED lights with 120° distribution angle. Requires 3 x AA batteries (not included).

Length	mm	255
Width	mm	40
Height	mm	29
Light	lumen	20
Magnetic pull	Nm	30 x 2 (approx.)
Weight	g	188



LED Work Lights

A 660mm wide work light with magnetic attachment for use with the TC-PA01 work panels or for fixing to any ferrous metal surface. 80 LED bulbs (7.2 watt) give good illumination on the work station (2,040 lumen). 230 volt and available with UK or Australian type plugs.

Stock no.	Plug Type
589ME	Euro



Hooks for Teng Tools Side plates and tool panels

Stock no.	Description
TCW-HK10	7 x 90°, 3 x 45° hooks
TCW-HK02	10 double hooks
TCW-HK20	4 x 45° single, 4 x 45° double hooks, 4 x 90° single, 4 small and 4 large spring clips
TCW-HK45	10 45° hooks for TCW-SP side plate
TCW-HK90	10 90° hooks for TCW-SP side plate
TCW-HKAIR	10 air tool hooks for TCW-SP side plate
TCW-HKB	10 large spring clip hooks



Panel set for 37" roller cabinets **NEW!**

A preconfigured set of panels, fixing bar, uprights and header to create a work station using the TCW207N 37" wide roller cabinet.

Stock No.	Description	TC-S03 contents	TC-S04 contents
TC-PA03	back panels	2	1
TC-FB03	fixing bar	1	1
TC-H05	header board	1	1
TC-UPRR	upright (R)	1	-
TC-UPRL	upright (L)	1	-
TC-UPRRS	upright (R)	-	1
TC-UPRLS	upright (L)	-	1

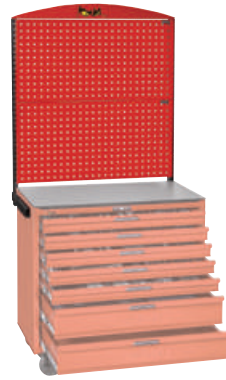

Stock No. TC-S03

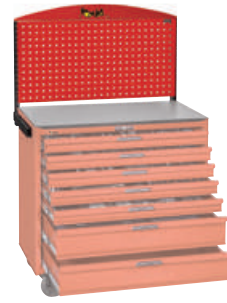

Stock No. TC-S04

Portable Tool Panels

The ideal way to store tools when the tools need to be moved around the work place such as in a workshop. The units are 1.6 meters tall, on castors, single or double sided and designed for use with Teng Tools work bench accessories giving the ability to hang additional tools and accessories using the wide range of Teng Tools hook on or magnetic shelves, hooks and wall racks.

Stock No	TPM01	TPM02
Contents		
Tool panels	2 x TC-PA01	4 x TC-PA01
Uprights	1 x TC-160UR	1 x TC-160UR
Fixing bars	2 x TC-FB01	2 x TC-FB01
Top signs	1 x TC-H01	1 x TC-H01



Portable Tool Panels

A single sided 1.6 meter tall (TPM01) portable tool panel unit supplied complete with four wall rack sets including a 10 piece screwdriver set (WRMD910N), a 4 piece plier set (WRMB04), a 12 piece metric combination spanner set (WRSP12) and a 7 piece T handle hex key set (WRHEX07).

Portable Work Station Uprights

Two 1.6 meter uprights with castors for use with panels, headers and fix bars to create your own portable work station.

Work Benches

Work benches with sturdy laminated, granite effect work surface with black edging. Supplied complete with a pair of fully adjustable legs to give a working height of between 707 and 927mm.

Stock no.	Length cm	Depth cm	Weight kilos
TWB1500	150	80	53
TWB2000	200	80	69

Panel Kits

A panel kit with uprights and fixing screws to fit to the work bench (as pictured). Each panel uses a square hole system for use with a range of hooks and accessories as well as the range of Teng Tools wall racks.

Stock no.	No. of panels
TWB-1500A	2
TWB-2000A	4

Work bench tops

Replacement work bench tops. Manufactured from double high density 37mm thickness board and laminated in a granite effect with black edging strip.

Stock no.	Dimensions mm	Weight kilos
TWB-15TOP	1500x800x37	33
TWB-20TOP	2000x800x37	44

TWB-UPR Uprights

Replacement upright for fixing TWB-PA panels to the 1.5 or 2 meter work benches.

TWB-PA Tool Panels

Add on panels measuring 895mm wide x 483mm high for use with the TWB-UPR uprights (as pictured) to add panels to the 1.5 or 2 meter work benches.

TWB-FB Fixing bar

875mm fixing bar for the 1.5 and 2 meter work benches

TWB-LEG Work bench legs

Pair of legs for the 1.5 or 2 meter Teng Tools work benches. Fully adjustable to give a working height of between 707 and 927mm.

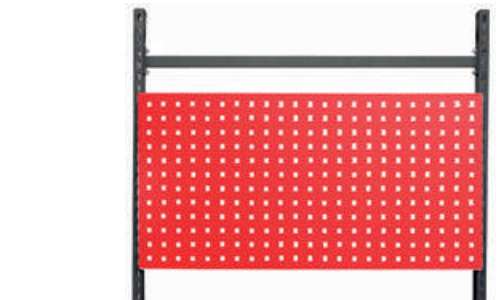
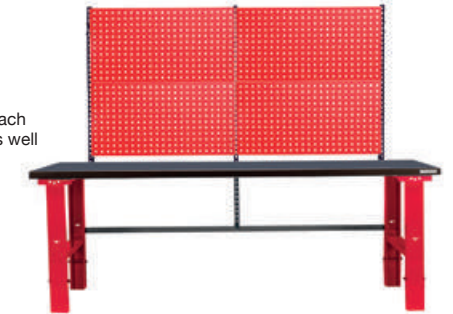

TWB-4WD Work bench wheels

Set of four 4" x 1 1/4" castor wheels with 1/2" bolts. With double brakes and a loading capacity of 80 kilos per piece or 250 kilos for the set of four.



TCB80 Wall hanging tool cabinet

Fully lockable wall mounted tool cabinet with a Teng Tools combination lock. Panels have square peg holes following the same system as the Teng Tools work bench panels and roller cabinet side plates. 660mm wide x 600mm high x 305mm deep. Weight 15 kilos.



TCB80A Wall hanging tool cabinet

Fully lockable wall mounted tool cabinet with a Teng Tools combination lock. Panels have square peg holes following the same system as the Teng Tools work bench panels and roller cabinet side plates. 660mm wide x 600mm high x 455mm deep. Weight 16.5 kilos.



TCB80C Wall hanging tool cabinet

Fully lockable wall mounted tool cabinet with a Teng Tools combination lock. 820mm wide x 900mm high x 250mm deep. Weight 24 kilos.



TCB135 Wall hanging tool cabinet

Fully lockable wall mounted tool cabinet with roller shutter front with a Teng Tools combination lock. Inside panel has square peg holes following the same system as the Teng Tools work bench panels and roller cabinet side plates. 1,335mm wide x 700mm high x 200mm deep. Weight 35.75 kilos.



TCB180 Wall hanging tool cabinet

Fully lockable wall mounted tool cabinet with sliding shutter front with a Teng Tools combination lock. Inside panel has square peg holes following the same system as the Teng Tools work bench panels and roller cabinet side plates. 1,800mm wide x 700mm high x 200mm deep. Weight 50 kilos.

Hook on trays for tool panels

Shelves that can be hooked on to the tool panels.

Stock No.	Width mm	Depth mm	Height mm	Weight g
TCT01	230	101	139	431
TCT02	460	101	140	796
TCT03	640	103	141	1,100



Hook on aerosol can holders for tool panels

Shelves that can be hooked on to the tool panels for storing aerosol cans, bottles, etc.

Stock No.	Width mm	Depth mm	Height mm	No. of holes for aerosol	Weight g
TCC01	230	98	136	2	411
TCC02	460	99	137	4	778
TCC03	640	100	138	6	1,093



TCT04 Hook tool holder for tool panels

A hook on holder for T bars, etc. Measures 103.5mm wide, 23.5mm deep and 178mm high. Weight 302g.



RACKING SYSTEM

Order in the stores with Teng Tools

Teng Tools takes Get Organised a step further! We now help you create order in the stores and in the warehouse.

We have developed a stable racking system with different modules which can be combined together in numerous different ways. You can easily tailor a storage system that suits the activities and work flow using corner sections, narrow or wide sections, drawer modules and shelves. And as the icing on the cake, there is a mobile trolley in two different widths in the same system.



Easy to assemble

The racking system is supplied as a flat pack and is easy to assemble. See the instructions at www.tengtools.com under Manuals.

Choose from our finished sections



Stock no: RSK1350A



Stock no: RSK0700

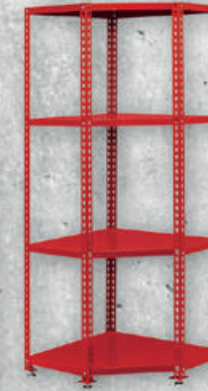

Stock no: RSKC02



Stock no: RSK0700A

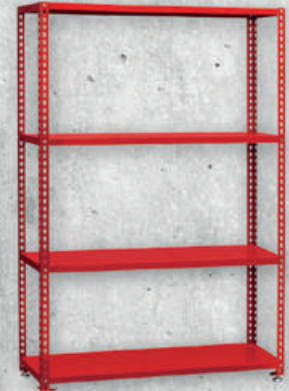

Stock no: RSK1350

Add shelves and drawer modules as required



Stock no: RSSS700



Stock no: RSS0700



Stock no: RSS1350



Stock no: RSSC01



Stock no: RSD07004



Stock no: RSD135004

Mobile trolleys



Stock no: TR070



Stock no: TR135

Mobile Trolley

A 700mm wide mobile work trolley with handle and castors – two fixed and two swivelling with brakes. Two shelves and ball bearing slide drawer are included. Height 770mm (932mm with wheels), width 700mm, depth 450mm. 35.2 kilos.



Extra Wide Mobile Trolley

A 1,339mm wide mobile work trolley with handle and castors – two fixed and two swivelling with brakes. Two shelves and ball bearing slide drawer are included. Height 770mm (932mm with wheels), width 1,339mm, depth 450mm. 55.2 kilos.

Modular Racking Shelving Units

Easy to assemble, sturdy modular racking units for use in any workshop area. Two meters high with adjustable feet, four shelves and a choice of 700mm or 1,339mm widths.

Stock No.	Height mm	Width mm	Depth mm	Weight kilos	Max load capacity per shelf (kilos)
RSK0700	2,000	700	450	38.0	300
RSK1350	2,000	1,339	450	66.0	160



Modular Racking Shelf and Drawer Units

Easy to assemble, sturdy modular racking units for use in any workshop area. Two meters high with adjustable feet, and a four drawer module together with three shelves (one sliding) and a choice of 700mm or 1,339mm widths.

Stock No.	Height mm	Width mm	Depth mm	Weight kilos	Max load capacity per shelf (kilos)
RSK0700A	2,000	700	450	56.5	300
RSK1350A	2,000	1,339	450	103.0	160

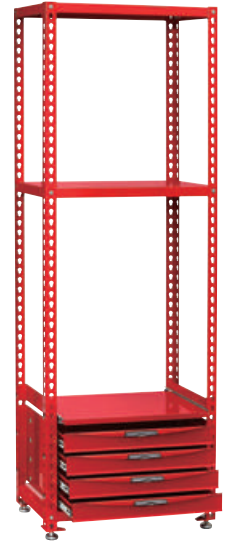

Modular Racking Corner Shelf Units

Easy to assemble, sturdy modular racking units for use in any workshop area. Two meters high with adjustable feet and four shelves. 90° angle for use in a corner.

Stock No.	Height mm	Width mm	Depth mm	Weight kilos	Max load capacity per shelf (kilos)
RSKC02	2,000	800	800	99.0	300



EVERY SECOND COUNTS

POLE POSITION ACCORDING TO TENG



Get organised™

Modular Racking Drawer Modules

Drawer modules for use with the Teng Tools modular racking system. Four drawers with ball bearing slides and a choice of widths.

Stock No.	Height mm	Width mm	Depth mm	Weight kilos
RSD070004	310	603	378	21.6
RSD135004	413	1,215	378	44.6



Uprights

Two meter uprights for use as part of the Teng Tools modular racking system.

Stock No.	Height mm	Width mm	Depth mm	Weight kilos
RSRU01	2,000	45	45	3.5



Shelves

Metal shelves for use as part of the Teng Tools modular racking system. Available in two different widths.

Stock No.	Height mm	Width mm	Depth mm	Weight kilos
RSS0700	35	698	445	5.0
RSS1350	35	1,335	445	8.5



Corner shelves

Metal corner shelves for use as part of the Teng Tools modular racking system.

Stock No.	Height mm	Width mm	Depth mm	Weight kilos
RSSC01	35	795	795	11.8



Sliding Shelves

Sliding metal shelves for use as part of the Teng Tools modular racking system. Available in two different widths.

Stock No.	Height mm	Width mm	Depth mm	Weight kilos
RSSS700	22.5	583	430	5.1
RSSS1350	22.5	1,223	430	8.5



WALL RACKS

Organise and keep order with the help of Teng Tools!

A comprehensive range of tool holders that are ideal to attach to tool panels above a bench or to mount directly on the wall. The holders are perfect for the storage of tools you use frequently, they create order and make the tools easy to reach.

- There are 19 different sets, including sets for combination spanners, screwdrivers, pliers and files.
- There is a special space marked out for each tool so it is easy to see which tool is missing.
- Can be attached to tool panels above the bench or on the wall so that all tools are easy to reach.
- All tools can be purchased separately, so lost tools are easy to replace.
- Template and fittings included.



WR8012 Anti Slip Combination Spanner Set

12 piece metric combination spanner set featuring a typically Teng new design in combination spanners that gives an anti slip grip on the open end as well as the Teng Tools hip grip function where the spanner drives on the flank of the fastening rather than the corner, two design features that combine to give a much better grip with much less risk of damage to the fastening. The design also gives grip on fastenings with worn or rounded corners. Complete with a wall rack for fixing to the wall or a work bench.

Combination spanners	8, 9, 10, 11, 12, 13, 14, 15, 16, 17, 18, 19mm
----------------------	--

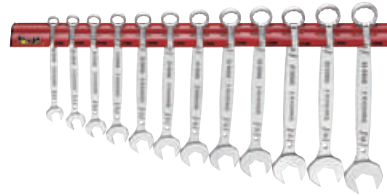

WRSP12 Combination Spanner Set

12 piece metric combination spanner set. Satin finish. Chrome vanadium. Complete with a wall rack for fixing to the wall or a work bench.

Combination spanners	8, 9, 10, 11, 12, 13, 14, 15, 16, 17, 18, 19mm
----------------------	--



WRSP12LMP Long Reach Combination Spanner Set

12 piece extra long metric combination spanner set. Satin finish. Chrome vanadium. Complete with a wall rack for fixing to the wall or a work bench.

Combination spanners	8, 9, 10, 11, 12, 13, 14, 15, 16, 17, 18, 19mm
----------------------	--



WRSP12RS Ratcheting Combination Spanner Set

12 piece ratcheting combination spanner set. Satin finish. Chrome vanadium. Complete with a wall rack for fixing to the wall or a work bench.

Combination spanners	8, 9, 10, 11, 12, 13, 14, 15, 16, 17, 18, 19mm
----------------------	--



WRDF06 Double Flex Wrench Set

6 piece double flex wrench set, with different size swivelling 12 point sockets at each end. Satin finish. Chrome vanadium. Complete with a wall rack for fixing to the wall or a work bench.

Double flex wrenches	8x9, 10x11, 12x13, 14x15, 16x17, 18x19mm
----------------------	--



WRFLS05 Extra long double ring spanner Set

5 piece extra long double ring spanner set covering 8 to 24mm with different bi-hexagonal sizes at each end. Satin finish. Chrome vanadium. Complete with a wall rack for fixing to the wall or a work bench.

Double ring spanners	8x10, 11x13, 12x14, 17x19, 22x24mm
----------------------	------------------------------------



TPPSTQ04 Preset Torque Wrench set

Set of four 1/2" drive preset torque wrenches, set to 90, 110, 120 and 140Nm. Accuracy +/- 4% and DIN3122. Supplied in the unique Teng Tools PS tray for use on it's own or as part of the Teng Tools TC control system. Also supplied with a wall rack for fixing to the wall or a work bench.

1/2" drive preset torque wrenches	90, 110, 120, 140Nm
-----------------------------------	---------------------



WRHEX07 T handle hex key set

7 piece metric T handle hex key set with a ball point end on the long arm for 30° access. Complete with a wall rack for fixing to the wall or a work bench.

T handle hex keys	2.5, 3, 4, 5, 6, 7, 8mm
-------------------	-------------------------



WRHEX07AF T handle hex key set

7 piece imperial T handle hex key set with a ball point end on the long arm for 30° access. Complete with a wall rack for fixing to the wall or a work bench.

T handle hex keys	3/32", 1/8", 5/32", 3/16", 7/32", 1/4", 5/16"
-------------------	---



WRTX07 T handle TX key set

7 piece T handle TX key set with a TPX end on the long arm for tamper proof TX fastenings. Complete with a wall rack for fixing to the wall or a work bench.

T handle TX keys	TX10, TX15, TX20, TX25, TX27, TX30, TX40
------------------	--



WRMD10N Screwdriver Set

10 piece screwdriver set. Screwdrivers have bi-material TPR grip for added comfort and grip. Complete with a wall rack for fixing to the wall or a work bench.

Screwdrivers	flat type	0.5x3.0x100, 1.0x5.5x75, 1.0x5.5x150, 1.2x6.5x150, 1.2x8.0x150mm
	PH	PH0x75, PH1x75, PH2x100mm
	PZ	PZ1x75, PZ2x100mm



WRMDT05N Power through screwdriver set

5 piece power thru screwdriver set. Screwdrivers have bi-material TPR grip for added comfort and grip with a percussion cap in the head for striking with a hammer. Complete with a wall rack for fixing to the wall or a work bench.

Screwdrivers	flat type	1.2x6.5x100, 1.2x8.0x150, 1.6x10x200mm
	PH	PH2x100, PH3x150mm



WRMDV05N 1,000 volt insulated screwdriver set

5 piece 1,000 volt insulated screwdriver set. Screwdrivers have bi-material TPR grip for added comfort and grip. Complete with a wall rack for fixing to the wall or a work bench.

Screwdrivers	flat type	0.5x3.0x100, 1.0x5.5x125mm
	PH	PH1x80, PH2x100mm
	PZ	PZ2x100mm



WRMDV07N 1,000 volt insulated screwdriver set

7 piece 1,000 volt insulated screwdriver and voltage tester set. Screwdrivers have bi-material TPR grip for added comfort and grip. Complete with a wall rack for fixing to the wall or a work bench.

Screwdrivers	flat type	0.4x2.5x75, 0.5x3.0x100, 0.8x4.0x100, 1.0x5.5x125mm
	PH	PH1x80, PH2x100mm
Voltage tester		100 to 250 volts

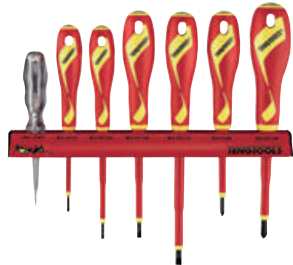

WRMB04 4 Piece Plier Set

4 piece plier set. Pliers have bi-material TPR grip for added comfort and grip. Complete with a wall rack for fixing to the wall or a work bench.

Pliers	6" side cutters, 7" heavy duty combination, 8" long nose and 10" water pump
--------	---



WRMBV04 1,000 volt insulated plier set

4 piece 1,000 volt insulated plier set. Pliers have bi-material TPR grip for added comfort and grip. Complete with a wall rack for fixing to the wall or a work bench.

Pliers	6" side cutters, 8" heavy duty side cutters, 7" combination and 8" long nose
--------	--

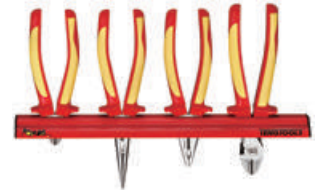

WRWC07 Carpenters Chisel Set

A 7 piece chisel set, finely ground and lacquer coated for corrosion protection. Impact resistant soft grip handles with percussion caps. Each chisel has a plastic blade cover. Supplied with a Teng Tools wall rack for fixing to tool panels or a work bench.

Wood chisels	6, 10, 12, 16, 18, 20 and 25mm chisels.
--------------	---



WRFL05 Engineers File Set

A 5 piece set of 10" hand files. Supplied with a Teng Tools wall rack for fixing to tool panels or a work bench.

Sizes	10" flat file, 10" hand file, 10" half round file, 10" round file, 10" three square file
-------	--



WRPC10 Punch and chisel set

A 10 piece punch and chisel set including parallel pin punches, a centre punch and cold chisels. Supplied with a Teng Tools wall rack for fixing to tool panels or a work bench.

Centre punch	5x150mm
Parallel pin punches	3, 4, 5, 6, 7, 8mm
Cold chisels	19x150, 25x200, 25x250mm



SOCKET SETS

Teng Tools socket sets

Teng Tools socket sets are organised in cases with functions and benefits that will make your daily work easier. When designing the box we have concentrated on making it practical, durable and easy to transport and work with. Besides, it's stylish too...



- Retractable handle, especially designed for comfort and durability.
- Secure lock system with click mechanism so you know the top is closed properly.
- The divider, which keeps the tools in place, is attached by a hinge on the outer edge so it can be moved to one side when using the tool set.
- Hard-wearing hinge with metal pin for increased life.
- Rubber feet to prevent the box from sliding and which protects against scratching.
- Distinctive branding to show your choice of Teng Tools.
- Easy and clear layout makes it easier to see which tools are missing when the work is done.
- Fully recyclable packaging to protect the environment.



1/4" Drive Socket Sets

M1413N1 1/4" Drive Socket Set

A basic no-nonsense 1/4" drive set of sockets with the FRP ratchet and an extension bar. Supplied in the Teng Tools clip box which stores the sockets and includes a clip rail facility for adding extra sockets.



Accessories	1/4" drive		FRP ratchet, 2" extension bar,
Regular sockets	1/4" drive	6 point	4, 5, 5.5, 6, 7, 8, 9, 10, 11, 12, 13mm

T1419 19 Piece 1/4" Drive Socket Set

19 piece 1/4" drive socket set containing 6 point sockets, bits ratchet handle, magnetic bits holder, plus 11 bits. Supplied in a plastic case with snap lock and metal pin hinges. (105x60x32mm, 0.25 kilos)



Accessories	1/4" drive		1/4" bits ratchet, magnetic bits holder, 1/4"Mx1/4"Hex adaptor
Regular sockets	1/4" drive	6 point	8, 9, 10, 11, 12, 13mm
Bits	1/4" hex		4, 5, 6mm hex, PH1, PH2, PZ1, PZ2, 4.5mm flat, 5.5mm flat, 6.5mm flat

T1420 20 Piece 1/4" Drive Socket Set

20 piece 1/4" drive socket set containing 6 point sockets, bits ratchet handle, magnetic bits holder, plus 11 bits. Supplied in a plastic case with snap lock and metal pin hinges. (105x60x32mm, 0.2 kilos)



Accessories	1/4" drive		1/4" bits ratchet, magnetic bits holder, 1/4"Mx1/4"Hex adaptor
Regular sockets	1/4" drive	6 point	5.5, 6, 7, 8, 9, 10, 13mm
Bits	1/4" hex		TX10, TX15, TX20, PH1, PH2, PZ1, PZ2 4mm flat, 5.5mm flat, 6.5mm flat

T1422 22 Piece 1/4" Drive Socket Set

22 piece 1/4" drive socket set containing 6 point sockets, 72 teeth ratchet handle, 2" extension bar, bits holder, 10 bits and hanging hook. Supplied in a plastic case with snap lock and metal pin hinges. (170x90x35mm, 0.45 kilos)



Accessories	1/4" drive		72 teeth ratchet, coupler adaptor, 2" extension bar
Regular sockets	1/4" drive	6 point	4, 5, 5.5, 6, 7, 8, 9, 10, 11, 12, 13mm
Bits	1/4" hex		TX10, TX15, TX20, 4mm flat, 5.5mm flat, 6.5mm flat, PH1, PH2, PZ1, PZ2

T1423 23 Piece 1/4" Drive Socket Set

23 piece 1/4" drive socket set containing 6 point sockets, mini bits ratchet, 2" extension bar, 10 bits and a 4" adjustable wrench. Supplied in a plastic case with snap lock and metal pin hinges. (170x90x35mm, 0.42 kilos)



Regular sockets	1/4" drive	6 point	4, 5, 5.5, 6, 7, 8, 10, 12, 13mm
Adjustable wrench			4"
Accessories	1/4" drive		2" extension, 1/4" bit ratchet, 1/4" male:1/4" hex adaptor
Bits	1/4" hex		4, 5, 5.5, 6.5mm flat, PH1, PH2, PZ1, PZ2, TX10, TX15, TX20

T1424 24 Piece 1/4" Drive Socket Set

24 piece 1/4" drive socket set containing 6 point sockets, FRP ratchet, 3" extension bar, universal joint, bits holder as well as PH, flat, hex and TX bits. Supplied in a plastic case with snap lock and metal pin hinges. (170x90x35mm, 0.5 kilos)



Regular sockets	1/4" drive	6 point	4, 5, 5.5, 6, 7, 8, 10, 11, 12, 13
Accessories	1/4" drive		FRP ratchet, 3" extension bar, universal joint, bits holder
Bits	1/4" hex		PH1, PH2, 3mm hex, 5mm hex, 6mm hex, TX10, TX15, TX20, 4mm flat, 5.5mm flat

T1424S 24 Piece 1/4" Drive Socket Set

24 piece 1/4" drive socket set containing 6 point sockets, 72 teeth flexible ratchet, couple adaptor, universal joint, 3' extension bar, 10 regular sockets, and 10 bits. Supplied in a plastic case with snap lock and metal pin hinges. (170x90x35mm, 0.45 kilos)



Accessories	1/4" drive		72 teeth flexible ratchet, coupler adaptor, universal joint, 3" extension bar
Regular sockets	1/4" drive	6 point	4, 5, 5.5, 6, 7, 8, 10, 11, 12, 13mm
Bits	1/4" hex		3mm hex, 5mm hex, 6mm hex, TX10, TX15, TX20, 4mm flat, 5.5mm flat, PH1, PH2.

T1435AF 35 Piece 1/4" Drive AF Socket Set

35 piece 1/4" drive socket set containing regular and deep 6 point AF sockets, FRP ratchet, 11 screwdriver bits, universal joint, 2" and 4" extension bars, coupler adaptor, 3/8" - 1/4" adaptor and hex keys 1.5, 2.0 and 2.5mm. Supplied in a plastic case with snap lock and metal pin hinges. (240x125x38mm, 1.1 kilos)



Accessories	1/4" drive		FRP ratchet, universal joint, 2" & 4" extensions, coupler adaptor 3/8"F:1/4"M T-bar adaptor, 1.5, 2.0 & 2.5mm hex keys
Regular sockets	1/4" drive	6 point	3/16" 7/32" 1/4" 9/32" 5/16" 11/32" 3/8" 7/16" 1/2"
Deep sockets	1/4" drive	6 point	3/16" 1/4" 5/16" 3/8" 7/16" 1/2"
Bits	1/4" hex		TX10, TX15, TX20, 5mm hex, 6mm hex, PH1, PH2, PZ1, PZ2, 4mm flat, 5.5mm flat

T1436 36 Piece 1/4" Drive Socket Set

36 piece 1/4" drive socket set containing 6 point sockets, FRP ratchet, coupler adaptor, 3/8"-1/4" adaptor, 2" and 4" extension bars, universal joint, three hex keys and 11 bits. Supplied in a plastic case with snap lock and metal pin hinges. (240x125x38mm, 0.9 kilos)

Accessories	1/4" drive	FRP ratchet, universal joint, 2" & 4" extensions, coupler adaptor, 3/8" F:1/4" M T-bar adaptor, 1.5, 2.0 & 2.5mm hex keys
Regular sockets	1/4" drive 6 point	4, 5, 5.5, 6, 7, 8, 10, 11, 12, 13mm
Deep sockets	1/4" drive 6 point	6, 7, 8, 10, 12, 13mm
Bits	1/4" hex	TX10, TX15, TX20, 5mm hex, 6mm hex, PH1, PH2, PZ1, PZ2, 4mm flat, 5.5mm flat



T1460 60 Piece 1/4" Drive Socket Set

60 piece 1/4" drive socket set containing 6 point regular/deep metric/AF sockets, bit sockets, FRP ratchet, 1/4" hex bits holder, 2" and 4" extension bars, spinner handle, universal joint, T bar and screwdriver bits. Supplied in a plastic carrying case with latch lid, retractable handle and metal pin hinges. The underside of the case is fitted with rubber feet to prevent it from sliding. (350x180x55mm, 1.6 kilos)

Accessories	1/4" drive	FRP ratchet, bits holder 1/4" hex, 2" and 4" extension bars, spinner handle, universal joint, T bar
Regular sockets	1/4" drive 6 point	4, 4.5, 5, 5.5, 6, 7, 8, 9, 10, 11, 12, 13mm
Deep sockets	1/4" drive 6 point	3/16" 7/32" 1/4" 9/32" 5/16" 11/32" 3/8" 7/16" 1/2" 6, 7, 8, 10, 12, 13mm 1/4" 5/16" 3/8" 7/16" 1/2"
Bit sockets	1/4" drive	4mm, 5.5mm, 7mm flat, TX10, TX15, TX20, TX25, TX27, PH1, PH2
Bits (25mm)	1/4" hex	4mm, 5.5mm flat, 5mm hex, 6mm hex, PH1, PH2, PZ1, PZ2



TM106 106 Piece 1/4" 3/8" & 1/2" Drive Socket Set

106 piece professional tool set, containing 1/4" and 3/8" drive regular 6 point sockets, 1/4" drive deep sockets, 3/8" drive spark plug sockets, 1/2" drive regular 12 point sockets, FRP ratchets, universal joints coupler adaptors, extension bars, bi-flex wrench, bit driver, adaptors, double flex wrenches, combination spanners, ring holder, adjustable wrench and a full range of screwdriver bits. Supplied in a plastic carrying case with latch lid, retractable handle and metal pin hinges. The underside of the case is fitted with rubber feet to prevent it from sliding. (466x258x103mm, 7.85 kilos)



Accessories	1/4" drive	FRP ratchet, bi-flex wrench, universal joint, 2" & 3" extensions, coupler adaptor, bits driver handle with magnetic bits holder
Accessories	3/8" drive	FRP ratchet, 3" & 6" extensions, universal joint, 3/8" F:1/4" M T bar adaptor, 3/8" F:1/2" M T bar adaptor, coupler adaptor
Accessories	1/2" drive	2 1/2" & 10" extensions, 1/2" F:3/8" M T bar adaptor, flex head adaptor
Regular sockets	1/4" drive 6 point	4, 5, 6, 7, 8, 10, 12, 13mm
Deep sockets	1/4" drive 6 point	6, 7, 8, 10, 12, 13mm
Regular sockets	3/8" drive 6 point	8, 9, 10, 12, 13, 14, 15, 16, 17, 18, 19, 21, 22mm
Spark plug sockets	3/8" drive	16, 21mm
Regular sockets	1/2" drive 12 point	19, 24, 27, 30, 32mm
Bits (25mm)	1/4" hex	TX8, TX10, TX15, TX20, TX25, TX27, TX30, TX40, TPX10, TPX15, TPX20, TPX25, TPX27, TPX30, TPX40 3mm hex, 4mm hex, 5mm, 6mm hex, 8mm hex, 10mm hex, PH0, PH1, PH2, PH3, PZ1, PZ2, PZ3, 4mm flat, 5.5mm flat, 7mm flat, XZN M5, XZN M6
Wrenches		8, 9, 10, 11, 12, 13, 14, 15, 16, 17, 18, 19mm combination spanners, ring holder, 8x9mm, 10x11mm, 12x13mm, 14x15mm double flex wrenches, 10" adjustable

T1272 72 Piece 1/4" & 1/2" Socket Set

72 piece socket set containing 1/4" and 1/2" drive regular sockets and accessories together with a comprehensive range of socket accessories. Supplied in a plastic carrying case with latch lid, retractable handle and metal pin hinges. The underside of the case is fitted with rubber feet to prevent it from sliding. (480x248x68mm, 4.6 kilos)



Accessories	1/4" drive	FRP ratchet, bi-flex wrench, 4" extension bar, coupler adaptor
Accessories	1/2" drive	FRP ratchet, 5" & 10" extension bars, 3/8" F:1/2" M T bar adaptor, flex head adaptor, universal joint
Regular sockets	1/4" drive 6 point	4, 5, 5.5, 6, 7, 8, 10, 11, 12, 13mm
Regular sockets	1/2" drive 12 point	10, 11, 12, 13, 14, 15, 16, 17, 18, 19, 20, 21, 22, 23, 24, 27mm
Bits	1/4" hex	TX8, TX10, TX15, TX20, TX25, TX27, TX30, TX40, 3mm hex, 4mm hex, 5mm hex, 6mm hex, 8mm hex, 10mm hex, 1/8" hex, 9/64" hex, 5/32 hex, 3/16" hex, 7/32" hex, 1/4" hex, 3/8" hex, PH0, PH1, PH2, PH3, PZ1, PZ2, PZ3, 4mm flat, 5.5mm flat, 7mm flat, XZN M5, XZN M6
Hex keys		1.5, 2.0, 2.5mm

TM095 1/4" and 1/2" Drive Socket and Tool Set

95 piece 1/4" and 1/2" drive socket set containing regular and deep 1/4" drive metric sockets, 1/2" drive regular 6 point sockets, FRP ratchets, universal joints, extension bars, 1/2" drive spark plug sockets and other socket accessories and screwdriver bits. The set also includes combination spanners and screwdrivers. Supplied in a plastic carrying case with latch lid, retractable handle and metal pin hinges. The underside of the case is fitted with rubber feet to prevent it from sliding. (466x258x103mm, 6.3 kilos)

Accessories	1/4" drive	FRP ratchet, universal joint, 2" and 4" extensions, sliding T bar, spinner handle, coupler adaptor, 50mm magnetic bit holder
Regular sockets	1/4" drive 6 point	4, 4.5, 5, 5.5, 6, 7, 8, 9, 10, 11, 12, 13mm
Deep sockets	1/4" drive 6 point	4, 5, 6, 7, 8, 9, 10, 11, 12, 13mm
Regular sockets	1/2" drive 6 point	10, 11, 12, 13, 14, 15, 17, 19, 22, 24, 27, 30, 32mm
Accessories	1/2" drive	FRP ratchet, 5" and 10" extensions, 3/8" F:1/2" M T bar adaptor, universal joint, 5/16" hex coupler Adaptor, 21mm spark plug socket
Combination spanners		8, 10, 12, 13, 14, 17mm
Screwdrivers		PH1x75mm, PH2x100mm, PZ1x75mm, PZ2x100mm, 3mm flat x 75mm, 4mm flat x 100mm
Bits (25mm)	1/4" hex	4, 5.5 and 7mm flat, PH0, PH1, PH2, PH3, PH4, PZ0, PZ1, PZ2, PZ3, 3, 4, 5, 6, 8 and 10mm hexagon, 1/4" male adaptor, TX8, TX10, TX15, TX20, TX25 TX27, TX30, TX40
Bits (30mm)	5/16" hex	TX45, TX50, TX55



From factory to workshop, from farms to motor racing - Teng Tools is the preferred choice for professionals.

TM111 111 Piece Socket Set

111 piece socket set containing 1/4", 3/8" and 1/2" drive regular sockets and accessories, 3/8" drive deep sockets, spark plug sockets plus 1/4" and 5/16" hex bits. Supplied in a plastic carrying case with latch lid, retractable handle and metal pin hinges. The underside of the case is fitted with rubber feet to prevent it from sliding. (466x258x103mm, 8.1 kilos)



Accessories	1/4" drive	FRP ratchet, 5/16" hex coupler adaptor, 6" flexible extension, 2" and 4" extension bars, spinner handle, universal joint, 1/4" Fx3/8" M adaptor, 4" T bar
Accessories	3/8" drive	FRP ratchet, bits holder 1/4" hex, 3" and 6" extension bars, spinner handle, universal joint, 3/8" Fx1/2" M adaptor, spin disc
Accessories	1/2" drive	FRP ratchet, 5/16" hex coupler, 2 1/2" and 10" extension bars, 1/2" Fx3/8" M adaptor, spin disc
Regular sockets	1/4" drive 6 point	4, 5, 6, 7, 8, 10, 12mm
Regular sockets	3/8" drive 6 point	3/16" 7/32" 1/4" 9/32" 3/8" 7/16"
		8, 9, 10, 12, 13, 14, 15, 16, 17mm
Deep sockets	3/8" drive 6 point	3/8" 7/16" 1/2" 9/16" 11/16" 3/4" 13/16" 7/8"
		8, 9, 10, 12, 13, 14, 15, 16, 17mm
Regular socket	1/2" drive 6 point	17, 24, 27, 32mm
		11/16" 3/4" 13/16" 7/8" 1" 1 1/16"
Spark plug sockets	3/8" drive 6 point	16, 21mm
Bits	5/16" hex coupler adaptor	3mm hex, 4mm hex, 5mm hex, 6mm hex, 7mm hex, 10mm hex, 1/8" hex, 9/64" hex, 5/32" hex, 3/16" hex, 1/4" hex, 5/16" hex, TX10, TX15, TX20, TX25, TX30, TX40, 4mm, 5.5mm, 7mm flat, PH1, PH2, PH3, PZ1, PZ2, PZ3
Bits	5/16" hex	TX45, TX50

TM127 1/4", 3/8" and 1/2" Drive Metric and AF Socket and Tool Set

127 piece 1/4", 3/8" and 1/2" drive socket set containing regular and deep 1/4" drive sockets, 3/8" and 1/2" drive regular sockets, FRP ratchets, extension bars, universal joints, spark plug sockets, adaptors and screwdriver bits. The set also includes combination spanners, an adjustable wrench and a ratcheting bits driver. Supplied in a plastic carrying case with latch lid, retractable handle and metal pin hinges. The underside of the case is fitted with rubber feet to prevent it from sliding. (466x258x105mm, 7.5 kilos)

Accessories	1/4" drive	FRP ratchet, universal joint, 2" and 3" extension bars, coupler adaptor
Regular sockets	1/4" drive 6 point	4, 5, 5.5, 6, 7, 8, 10, 11, 12, 13mm
		3/16", 7/32", 1/4", 9/32", 5/16", 11/32", 3/8", 7/16", 1/2"
Deep sockets	1/4" drive 6 point	6, 7, 8, 10, 12, 13mm
Accessories	3/8" drive	FRP ratchet, universal joint, 3" and 6" extension bars, coupler adaptor, 16 and 21mm spark plug sockets, 3/8" F:1/4" M adaptor, 3/8" F:1/2" M adaptor
Regular sockets	3/8" drive 6 point	8, 9, 10, 11, 12, 13, 14, 15, 16, 17, 18, 19, 21, 22mm
		5/16", 3/8", 7/16", 1/2", 9/16", 5/8", 11/16", 3/4", 13/16", 7/8"
Accessories	1/2" drive	2 1/2" and 10" extension bars, flex head adaptor, 1/2" F:3/8" M adaptor
Regular sockets	1/2" drive 12 point	19, 24, 27, 30, 32mm
Wrenches		8, 9, 10, 11, 12, 13, 14, 15, 16, 17, 18, 19mm combination spanners, spanner ring, 8" adjustable wrench
Bits	1/4" hex	Ratcheting bits driver, 4mm (x 2), 5.5mm (x 2) and 7mm flat (x 2), PH0, PH1 (x 2) PH2 (x 2), PH3, PZ1 (x 2), PZ2 (x 2), PZ3, 1/4" M adaptor, 3, 4, 5, 6, 8, 10mm hex, 1/8", 9/64", 5/32", 3/16", 1/4", 3/8" hex, TX8, TX10, TX15, TX20, TX25, TX27, TX30, TX40, 5 and 6 XZN.



TT1435 1/4" drive socket set

Set containing 11 regular 6 point sockets, 6 deep 6 point sockets, 11 screwdriver bits, ratchet handle, universal joint, 2" and 4" extension bars, 1/4" coupler adaptor, 3/8"-1/4" adaptor and 1/4" screwdriver handle.

Supplied in the unique Teng Tools TC tray with dove tail joints for use on it's own or as part of the Teng Tools TC control system. (265x142x50mm, 1.0 kilos)

Accessories	1/4" drive	Ratchet, universal joint, 2" and 4" extensions, coupler adaptor, 3/8" F:1/4" M T bar adaptor, 6" spinner handle
Regular sockets	1/4" drive 6 point	4, 5, 5.5, 6, 7, 8, 9, 10, 11, 12, 13mm
Deep sockets	1/4" drive 6 point	6, 7, 8, 10, 12, 13mm
Bits	1/4" hex	TPX10, 15, 20, 5mm, 6 mm hex, PH1, PH2, PZ1, PZ2, 4 mm, 5.5 mm flat



TTAF32 1/4" & 3/8" AF socket set

Set containing 1/4" and 3/8" drive 6 point sockets, regular and deep. Supplied in the unique Teng Tools TC tray with removable lid and dove tail joints for use on it's own or as part of the Teng Tools TC control system. (265x142x50mm, 1.36 kilos)

Regular sockets	1/4" drive 6 point	3/16" 7/32" 1/4" 9/32" 5/16" 11/32" 3/8" 7/16" 1/2"
Deep sockets	1/4" drive 6 point	3/16" 7/32" 1/4" 9/32" 5/16" 11/32" 3/16" 3/8" 7/16" 1/2"
Regular sockets	3/8" drive 6 point	3/8" 7/16" 1/2" 9/16" 5/8" 11/16" 3/4"
Deep sockets	3/8" drive 6 point	3/8" 7/16" 1/2" 9/16" 5/8" 11/16" 3/4"



TTTX30 3/8" drive TX/TPX/TXE socket set

30 piece 3/8" drive bit socket set containing 28 TX, TPX and TX-E socket bits for internal and external heads plus 3/8" -1/4" adaptor, and 3" extension bar 3/8" drive. Supplied in the unique Teng Tools TC tray with removable lid and dove tail joints for use on it's own or as part of the Teng Tools TC control system. (265x142x50mm, 1.1 kilos)

Accessories	3/8" drive	3" extension, 3/8" F:1/4" M adaptor
TX bit sockets	3/8" drive	TX10, 15, 20, 25, 27, 30, 40, 45, 50
TPX bit sockets	3/8" drive	TPX10, 15, 20, 25, 27, 30, 40, 45, 50
TX-E sockets	1/4" drive	E4, E5, E6, E7, E8
	3/8" drive	E10, E12, E14, E16, E18



TTBS35 1/4" & 3/8" drive bit socket set

35 piece 1/4" and 3/8" drive set containing 33 bits for hex, TX, PH, PZ and flat type, plus 2 adaptors. Supplied in the unique Teng Tools TC tray with removable lid and dove tail joints for use on it's own or as part of the Teng Tools TC control system. (265x142x50mm, 1.25 kilos)

Bits sockets	1/4" drive	PH0, PH1, PH2, PH3, PZ1, PZ2, PZ3, 4mm flat, 4.5mm flat, 7mm flat, TX10, TX15, TX20, TX25, TX27, TX30, TX40
Hex bit sockets	3/8" drive metric	3, 4, 5, 5.5, 6, 7, 8, 10, 12mm
Hex bit sockets	3/8" drive AF	1/8" 5/32" 3/16" 7/32", 1/4" 5/16" 3/8"
Accessories		1/4" F:3/8" M adaptor, 3/8" F:1/4" M adaptor



TED1489 1/4" Drive Socket Set

Set containing 1/4" drive regular and deep sockets and a comprehensive range of accessories. Supplied in the unique Teng Tools double width TC tray with removable lid and dove tail joints for use on it's own or as part of the Teng Tools TC control system. The tools are held in place using the Teng Tools three colour pre-cut EVA foam tool control system. (265x284x50mm, 1.60 kilos)



Accessories	1/4" drive	72 teeth ratchet, spinner handle, 2" and 4" extension bars, universal joint, coupler adaptor, 3/8" F:1/4" M adaptor, 1/4" M:1/4" hex adaptor
Regular sockets	1/4" drive 6 point	4, 5, 5.5, 6, 7, 8, 9, 10, 11, 12, 13mm
Deep sockets	1/4" drive 6 point	4, 5, 5.5, 6, 7, 8, 9, 10, 12, 13mm
Bit sockets	1/4" drive	4, 5.5, 7mm flat, TX10, TX15, TX20, TX25, TX27, TX30, TX40, PZ1, PZ2, PZ3, PH0, PH1, PH2, PH3
25mm bits	1/4" hex drive	3, 4, 5.5, 7mm flat, TX8, TX10, TX15, TX20, TX25, TX27, TX30, TX40, TX45, PZ0, PZ1, PZ2, PZ3, PH0, PH1, PH2, PH3, PH4, 3, 4, 5, 6, 8, 10mm hex, 1/8", 9/64", 5/32", 3/16", 1/4", 5/16" hex, TPX10, TPX15, TPX20, TPX25, TPX27, TPX30, TPX40, XZN 5 and 6.

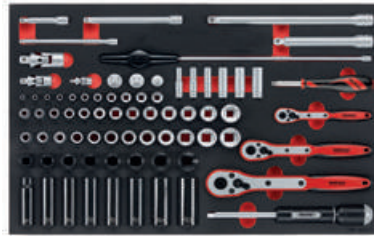

TTESK77 1/4" 3/8" 1/2" Drive Socket Set

76 piece 1/4", 3/8" and 1/2" drive socket set containing 1/4", 3/8" and 1/2" drive sockets and accessories. Covers all the popular sizes from 4 to 24mm with selected sizes in deep and a range of 1/2" drive impact sockets. Supplied in the Teng Tools three colour pre-cut EVA foam tool control system. (570x375x50mm, 7.2 kilos)

Accessories	1/4" drive	FRP ratchet, 6" spinner handle, 6" and 12" extension bars, universal joint, T-bar and T-bar handle adaptor.
Regular Sockets	1/4" drive 6 point	4, 5, 5.5, 6, 7, 8, 9, 10, 11, 12, 13mm
Deep Sockets	1/4" drive 6 point	7, 8, 10, 12, 13mm
Accessories	3/8" drive	FRP ratchet, 3" wobble extension bar, 6" extension bar, universal joint, 3/8" F:1/4" M adaptor, 3/8" F:1/2" M adaptor, rotating spinner handle.
Regular Sockets	3/8" drive 6 point	8, 9, 10, 11, 12, 13, 14, 15, 16, 17, 18, 19, 22mm.
Accessories	1/2" drive	FRP ratchet, 6" wobble extension bar, 10" extension bar, universal joint, 1/2" F:3/8" M adaptor.
Regular Sockets	1/2" drive 6 point	10, 11, 12, 13, 14, 15, 16, 17, 18, 19, 22mm
Impact Sockets	1/2" drive regular 6 point	13, 15, 16, 17, 18, 19, 22, 24mm
Impact Sockets	1/2" drive deep 6 point	13, 15, 16, 17, 18, 19, 22, 24mm



TTESK86 1/4" & 3/8" Drive Socket Set

Set containing 1/4" and 3/8" drive regular and deep metric sockets and a comprehensive range of accessories. Supplied in the Teng Tools three colour pre-cut EVA foam tool control system. (570x375x75mm, 6.55 kilos)

Accessories	1/4" drive	72 teeth ratchet, 6" spinner handle, 2" 3" 4" 6" and 12" extension bars, universal joint, 1/4" F:3/8" M adaptor, sliding T bar, coupler adaptor, T-HD T bar handle adaptor
Regular sockets	1/4" drive 6 point	4, 4.5, 5, 5.5, 6, 7, 8, 9, 10, 11, 12, 13mm
Deep sockets	1/4" drive 6 point	4, 5, 5.5, 6, 7, 8, 9, 10, 11, 12, 13mm
Accessories	3/8" drive	72 teeth ratchet, speed brace, spinner handle, 3", 5", 6", 10" and 20" extension bars, universal joint, 3/8" F:1/4" M adaptor, 3/8" F:1/2" M adaptor, 16mm, 18mm and 21mm spark plug sockets, coupler adaptor, 10" rotating spinner handle.
Regular sockets	3/8" drive 6 point	7, 8, 9, 10, 11, 12, 13, 14, 15, 16, 17, 18, 19, 20, 21 and 22mm
Deep sockets	3/8" drive 6 point	7, 8, 9, 10, 11, 12, 13, 14, 15, 16, 17, 18, 19, 20, 21 and 22mm

TTESK85 85 Piece 1/4" 3/8" 1/2" Drive Socket Set

85 piece socket bit set containing 1/4", 3/8" and 1/2" drive bit sockets. Covers all the popular types and sizes including screwdriver type, hex bits, TX and TPX, Ribe and XZN. Supplied in the Teng Tools three colour pre-cut EVA foam tool control system. (570x375x50mm, 4.5 kilos)

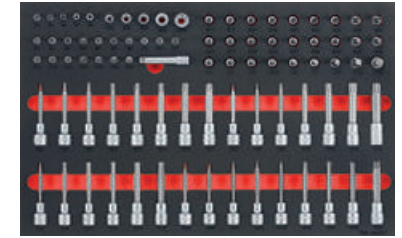

Flat bit sockets	1/4" drive 4, 5.5, 7mm	PH bit sockets	1/4" drive PH0, PH1, PH2, PH3
PZ bit sockets	1/4" drive PZ1, PZ2, PZ3	TX-E sockets	1/4" drive E4, E5, E6, E7, E8
TX bit sockets	1/4" drive TX10, TX15, TX20, TX25, TX27, TX30, TX40	Accessories	3/8" drive 3" extension bar
TX-E sockets	3/8" drive E10, E12, E14, E16, E18	TX bit sockets	3/8" drive TX10, TX15, TX20, TX25, TX27, TX30, TX40, TX45, TX50
TPX bit sockets	3/8" drive TPX10, TPX15, TPX20, TPX25, TPX27, TPX30, TPX40, TPX45, TPX50	Hex bit sockets	1/2" drive 3, 4, 5.5, 6, 7, 8, 10, 12mm
TX bit sockets	1/2" drive TX20, TX25, TX27, TX30, TX40, TX45, TX50, TX55, TX60	Hex bit sockets	1/2" drive 5, 6, 7, 8, 10, 12mm
Ribe bit sockets	1/2" drive 4, 5, 6, 8, 10, 11, 12, 13	XZN bit sockets	1/2" drive 5, 6, 8, 10, 12, 14, 16

M1412 1/4" Drive Regular Sockets

12 piece 1/4" drive 6 point regular sockets supplied on a clip rail. Chrome vanadium. Satin finish.

Accessories	1 clip rail (185mm in length) complete with 12 1/4" drive socket clips
Regular sockets	1/4" drive 6 point 4, 4.5, 5, 5.5, 6, 7, 8, 9, 10, 11, 12, 13mm



M1407 1/4" Drive Clip Rail Deep Sockets

9 piece 1/4" drive 6 point deep metric sockets supplied on a clip rail. Chrome vanadium steel. Satin finish.

Accessories	1 clip rail (165mm in length) complete with 9 1/4" drive socket clips
Deep sockets	1/4" drive 6 point 4, 5, 6, 7, 8, 9, 10, 12, 13mm



M3814 1/4" & 3/8" Drive TX-E Sockets

10 piece 1/4" and 3/8" drive TX-E sockets supplied on a clip rail. Chrome vanadium steel. Satin finish.

Accessories	1 clip rail (165mm in length) complete with 5 1/4" drive and 5 3/8" drive socket clips
TX-E sockets	1/4" drive E4, E5, E6, E7, E8
TX-E sockets	3/8" drive E10, E12, E14, E16, E18



M1408TX 1/4" Drive TX Bit Sockets

7 piece 1/4" drive TX sockets supplied on a clip rail.

Accessories	1 clip rail (110mm in length) complete with 7 1/4" drive socket clips
TX bit sockets	1/4" drive TX10, TX15, TX20, TX25, TX27, TX30, TX40



3/8" Drive Socket Sets

M3812N1 3/8" Drive Socket Set

A basic no-nonsense 3/8" drive set of sockets with the FRP ratchet and an extension bar. Supplied in the Teng Tools clip box which stores the sockets and includes a clip rail facility for adding extra sockets.



Accessories	3/8" drive	FRP ratchet, 3" extension bar
Regular sockets	3/8" drive	8, 10, 11, 12, 13, 14, 15, 16, 17, 19mm

T3834 34 Piece 3/8" Drive Socket Set

34 piece 3/8" drive socket set containing metric regular 6 point sockets, FRP ratchet, 3" and 6" extension bars, and an adaptor. Supplied in plastic case with snap lock and metal pin hinges. (240x125x38mm, 1.12 kilos)



Accessories	3/8" drive	FRP ratchet, 3" and 6" extension bars, 1/2"Fx3/8"M adaptor, coupler adaptor
Regular sockets	3/8" drive	6 point 8, 10, 11, 12, 13, 14, 15, 17, 19mm
Bits	25mm	1/4" hex 3mm flat, 4mm flat, 5.5mm flat, 3mm hex, 4mm hex, 5mm hex, 6mm hex, TX10, TX15, TX20, TX25, TX27, TX30, TX40, PH1, PH2, PH3, PZ1, PZ2, PZ3

T3834S 34 Piece 3/8" Drive Socket Set

34 piece 3/8" drive socket set containing 9 regular 6 point sockets, 72 teeth flexible ratchet, T bar adaptor, universal joint, 3" and 6" extension bars. Supplied in plastic case with snap lock and metal pin hinges. (240x125x38mm, 1.12 kilos)



Accessories	3/8" drive	72 teeth flexible ratchet, 1/4"Fx3/8"M T bar adaptor, universal joint, 3" and 6" extension bars, coupler adaptor
Regular sockets	3/8" drive	6 point 8, 10, 11, 12, 13, 14, 15, 17, 19mm
Bits	1/4" hex	3mm hex, 4mm hex, 5mm hex, 6mm hex, TX10, TX15, TX20, TX25, TX27, TX30, TX40, 3mm flat, 4mm flat, 5.5mm flat, PH1, PH2, PH3, PZ1, PZ2, PZ3.

T3835AF 35 Piece 3/8" Drive Socket Set

35 piece 3/8" drive set containing regular and deep AF 6 point sockets, 2 spark plug sockets 16 and 21mm, 11 screwdriver bits, FRP ratchet, universal joint, 4" and 6" extension bars, 1/2" - 3/8" adaptor as well as coupler adaptor. Supplied in a plastic carrying case with latch lid, retractable handle and metal pin hinges. The underside of the case is fitted with rubber feet to prevent it from sliding. (369x198x62mm, 2.2 kilos)



Accessories	3/8" drive	FRP ratchet, universal joint, 4" & 6" extensions, coupler adaptor, 1/2"Fx3/8"M T-bar adaptor
Regular sockets	3/8" drive	6 point 5/16" 3/8" 7/16" 1/2" 9/16" 5/8" 11/16" 3/4" 13/16" 7/8"
Deep sockets	3/8" drive	6 point 3/8" 7/16" 1/2" 9/16" 11/16" 3/4"
Spark plug sockets	3/8" drive	6 point 16 & 21mm
Bits	1/4" hex	TX10, TX15, TX20, 5mm hex, 6mm hex, PH1, PH2, PZ1, PZ2, 4mm flat, 5.5mm flat

T3839 39 Piece 3/8" Drive Socket Set

39 piece 3/8" drive socket set containing regular and deep metric 6 point sockets, coupler adaptor, 1/2"-3/8" adaptor, 3" wobble extension bar and 6" extension, universal joint, 2 spark plug sockets 16 and 21 mm, FRP ratchet as well as 11 bits. Supplied in a plastic carrying case with latch lid, retractable handle and metal pin hinges. The underside of the case is fitted with rubber feet to prevent it from sliding. (369x198x62mm, 2.46kilos)

Accessories	3/8" drive	FRP ratchet, universal joint, 3" wobble extension, 6" extension, coupler adaptor, 1/2"Fx3/8"M T-bar adaptor
Regular sockets	3/8" drive	6 point 8, 9, 10, 11, 12, 13, 14, 15, 16, 17,18, 19, 21, 22mm
Deep sockets	3/8" drive	6 point 8, 10, 12, 13, 17, 19mm
Spark plug sockets	3/8" drive	16 & 21mm
Bits	1/4" hex	TX10, TX15, TX20, 5mm hex, 6mm hex, PH1, PH2, PZ1, PZ2, 4mm flat, 5.5mm flat



T3840 39 Piece 3/8" Drive Socket and Spanner Set

39 piece 3/8" drive socket set containing 6 point metric sockets, 6" extension bar, universal joint, coupler adaptor, 1/2"-3/8" adaptor, FRP ratchet, 9 combination spanners as well as 11 screwdriver bits. Supplied in a plastic carrying case with latch lid, retractable handle and metal pin hinges. The underside of the case is fitted with rubber feet to prevent it from sliding. (369x198x62mm, 2.52 kilos)

Accessories	3/8" drive	FRP ratchet, universal joint, 6" extension, coupler adaptor, 1/2"Fx3/8"M T-bar adaptor
Regular sockets	3/8" drive	6 point 8, 9, 10, 11, 12, 13, 14, 15, 16, 17,18, 19, 21, 22mm
Combination spanners		8, 10, 11, 12, 13, 14, 15, 17, 19mm
Bits	1/4" hex	TX10, TX15, TX20, 5mm hex, 6mm hex, PH1, PH2, PZ1, PZ2, 4mm flat, 5.5mm flat



T3848 48 Piece 3/8" Drive Tool Set

48 piece 3/8" drive set containing 6 point regular metric and AF sockets, 2 spark plug sockets, 14 combination spanners, 6 screwdrivers, 5 pliers, adjustable wrench, FRP ratchet, 3" and 6" extension bars, coupler adaptor and 1/2"-3/8" adaptor. Supplied in a plastic carrying case with latch lid, retractable handle and metal pin hinges. The underside of the case is fitted with rubber feet to prevent it from sliding. (466x258x105mm, 6.51 kilos)

Accessories	3/8" drive	Ratchet, universal joint, 3" and 6" extension bars, coupler adaptor, 1/2"Fx3/8"M adaptor, 16 and 21mm spark plug sockets
Regular sockets	3/8" drive	6 point 7/16" 1/2" 9/16" 11/16" 8, 10, 12, 13, 14, 15, 16, 17, 18, 19, 21mm
Combination spanners		AF 7/16" 1/2" 9/16" 11/16" mm 8, 10, 12, 13, 14, 15, 16, 17, 18, 19mm
Screwdrivers		3.0mm flat, 5.5mm flat, 6.5mm flat, PH0, PH1, PH2,
Pliers		6" side cutter, 7" combination, 8" long nose, 10" water pump
Power grip pliers		7" curved jaw
Adjustable wrenches		8" phosphate finish



T3867 67 Piece 3/8" drive Tool Set

67 piece 3/8" drive tool set containing regular 6 point metric sockets, FRP ratchet handle, universal joint, 3" and 6" extension bars, coupler adaptor, 1/2" - 3/8" adaptor, bits driver with magnetic bits holder, 10 combination spanners, 6 screwdrivers, 4 pliers as well as 26 bits. Supplied in a plastic carrying case with latch lid, retractable handle and metal pin hinges. The underside of the case is fitted with rubber feet to prevent it from sliding. (466x258x103mm, 5.44 kilos)



Accessories	3/8" drive	FRP ratchet, 3" & 6" extensions, coupler adaptor, 1/2" F:3/8" M T-bar adaptor, bits driver handle with magnetic bits holder
Regular sockets	3/8" drive 6 point	8, 9, 10, 11, 12, 13, 14, 15, 16, 17, 18, 19, 20, 22mm
Combination spanners		8, 10, 11, 12, 13, 14, 15, 16, 17, 19mm
Screwdrivers		3.0mm flat, 5mm flat, 6mm flat, PH0, PH1, PH2,
Pliers		6" side cutter, 7" combination, 8" long nose, 10" water pump
Bits	1/4" hex	TX8, TX10, TX15, TX20, TX25, TX27, TX30, TX40, TX45, TX50, 3mm hex, 4mm hex, 5mm hex, 6mm hex, 8mm hex, 10mm hex, PH0, PH1, PH2, PH3, PZ1, PZ2, PZ3, 4mm flat, 5.5mm flat, 7mm flat

TM079 79 Piece 3/8" Tool Set

79 piece 3/8" socket and tool set. A service kit that contains a 3/8" drive socket set with FRP ratchet, bit sockets, universal joint, adaptor drive 1/2" x 3/8". Also included are: bit screwdriver with magnet, LED torch, measuring tape, universal knife, telescopic magnetic pick up, hook set for O-rings, universal pliers, carpenters hammer with steel tube handle, 1/4" adapter, 3/8" drive sockets, combination spanners, hex key set, adjustable wrench, flat nose pliers, side cutters, combination pliers, water pump pliers, screwdrivers and 20 bits. Supplied in a plastic carrying case with latch lid, retractable handle and metal pin hinges. The underside of the case is fitted with rubber feet to prevent it from sliding. (466x258x103mm, 6.8 kilos)



Accessories	3/8" drive	FRP ratchet, 5" extension, universal joint, 1/2" F:3/8" M T-bar adaptor, bits driver handle with magnetic bits holder
		1/4" hex adaptor, LED light with clip, 5m measuring tape, utility knife, telescopic magnet, 4 in 1 hook and pick set, gun saw, 16oz claw hammer
Regular sockets	3/8" drive 6 point	8, 10, 11, 12, 13, 14, 15, 17, 19, 20, 21, 22mm
Combination spanners		6, 7, 8, 10, 11mm
Hex key set		7 piece folding hex key set 1.5-6mm
Adjustable wrench		8" wide opening with vinyl grip
Screwdrivers		3.0mm flat, 5.5mm flat, 6.6mm flat, PH1, PH2,
Pliers		6" side cutter, 7" combination, 6" long nose, 7" water pump
Bits	1/4" hex	TX10, TX15, TX20, TX25, TX27, TX30, TX40, TPX20, TPX25, TPX30, 4mm hex, 5mm hex, 6mm hex, PH1, PH2, PH3, PZ1, PZ2, PZ3, 4.5mm flat, 5.5mm flat, 6.5mm flat, ROB no1, ROB no2, ROB no3, GR no2(x2)

TM079E 79 Piece 3/8" Tool Set

79 piece 3/8" socket and tool set. A service kit that contains a 3/8" drive socket set with FRP ratchet, bit sockets, universal joint, adaptor drive 1/2" x 3/8". Also included are: bit screwdriver with magnet, LED torch, measuring tape, universal knife, telescopic magnetic pick up, hook set for O-rings, universal pliers, engineers hammer, 1/4" adapter, 3/8" drive sockets, combination spanners, hex key set, adjustable wrench, flat nose pliers, side cutters, combination pliers, water pump pliers, screwdrivers and 20 bits. Supplied in a plastic carrying case with latch lid, retractable handle and metal pin hinges. The underside of the case is fitted with rubber feet to prevent it from sliding. (466x258x103mm, 6.8 kilos)



Accessories	3/8" drive	FRP ratchet, 5" extension, universal joint, 1/2" F:3/8" M T-bar adaptor, bits driver handle with magnetic bits holder
		1/4" hex adaptor, LED light with clip, 5m measuring tape, utility knife, telescopic magnet, 4 in 1 hook and pick set, gun saw, 500g engineers hammer
Regular sockets	3/8" drive 6 point	8, 10, 11, 12, 13, 14, 15, 17, 19, 20, 21, 22mm
Combination spanners		6, 7, 8, 10, 11mm
Hex key set		7 piece folding hex key set 1.5-6mm
Adjustable wrench		8" wide opening with vinyl grip
Screwdrivers		3.0mm flat, 5.5mm flat, PH1, PH2,
Pliers		6" side cutter, 7" combination, 6" long nose, 7" water pump
Bits	1/4" hex	TX10, TX15, TX20, TX25, TX27, TX30, TX40, TPX20, TPX25, TPX30, 4mm hex, 5mm hex, 6mm hex, PH1, PH2, PH3, PZ1, PZ2, PZ3, 4.5mm flat, 5.5mm flat, 6.5mm flat, ROB no1, ROB no2, ROB no3, GR no2(x2)

TM106 106 Piece 1/4" 3/8" & 1/2" Drive Socket Set

106 piece professional tool set, containing 1/4" and 3/8" drive regular 6 point sockets, 1/4" drive deep sockets, 3/8" drive spark plug sockets, 1/2" drive regular 12 point sockets, FRP ratchets, universal joints coupler adaptors, extension bars, bi-flex wrench, bit driver, adaptors, double flex wrenches, combination spanners, ring holder, adjustable wrench and a full range of screwdriver bits. Supplied in a plastic carrying case with latch lid, retractable handle and metal pin hinges. The underside of the case is fitted with rubber feet to prevent it from sliding. (466x258x103mm, 7.85 kilos)



Accessories	1/4" drive	FRP ratchet, bi-flex wrench, universal joint, 2" & 3" extensions, coupler adaptor, bits driver handle with magnetic bits holder
Accessories	3/8" drive	FRP ratchet, 3" & 6" extensions, universal joint, 3/8" F:1/4" MT bar adaptor, 3/8" F:1/2" M T bar adaptor, coupler adaptor
Accessories	1/2" drive	2 1/2" & 10" extensions, 1/2" F:3/8" M T bar adaptor, flex head adaptor
Regular sockets	1/4" drive 6 point	4, 5, 6, 7, 8, 10, 12, 13mm
Deep sockets	1/4" drive 6 point	6, 7, 8, 10, 12, 13mm
Regular sockets	3/8" drive 6 point	8, 9, 10, 12, 13, 14, 15, 16, 17, 18, 19, 21, 22mm
Spark plug sockets	3/8" drive	16, 21mm
Regular sockets	1/2" drive 12 point	19, 24, 27, 30, 32mm
Bits (25mm)	1/4" hex	TX8, TX10, TX15, TX20, TX25, TX27, TX30, TX40, TPX10, TPX15, TPX20, TPX25, TPX27, TPX30, TPX40 3mm hex, 4mm hex, 5mm, 6mm hex, 8mm hex, 10mm hex, PH0, PH1, PH2, PH3, PZ1, PZ2, PZ3, 4mm flat, 5.5mm flat, 7mm flat, XZN M5, XZN M6
Wrenches		8, 9, 10, 11, 12, 13, 14, 15, 16, 17, 18, 19mm combination spanners, ring holder, 8x9mm, 10x11mm, 12x13mm, 14x15mm double flex wrenches, 10" adjustable

TM111 111 Piece Socket Set

111 piece socket set containing 1/4", 3/8" and 1/2" drive regular sockets and accessories, 3/8" drive deep sockets, spark plug sockets plus 1/4" and 5/16" hex bits. Supplied in a plastic carrying case with latch lid, retractable handle and metal pin hinges. The underside of the case is fitted with rubber feet to prevent it from sliding. (466x258x103mm, 8.1 kilos)



Accessories	1/4" drive	FRP ratchet, 5/16" hex coupler adaptor, 6" flexible extension, 2" and 4" extension bars, spinner handle, universal joint, 1/4" Fx3/8" M adaptor, 4" T bar
Accessories	3/8" drive	FRP ratchet, bits holder 1/4" hex, 3" and 6" extension bars, spinner handle, universal joint, 3/8" Fx1/2" M adaptor, spin disc
Accessories	1/2" drive	FRP ratchet, 5/16" hex coupler, 2 1/2" and 10" extension bars, 1/2" Fx3/8" M adaptor, spin disc
Regular sockets	1/4" drive 6 point	4, 5, 6, 7, 8, 10, 12mm
		3/16" 7/32" 1/4" 9/32" 3/8" 7/16"
Regular sockets	3/8" drive 6 point	8, 9, 10, 12, 13, 14, 15, 16, 17mm
		3/8" 7/16" 1/2" 9/16" 11/16" 3/4" 13/16" 7/8"
Deep sockets	3/8" drive 6 point	8, 9, 10, 12, 13, 14, 15, 16, 17mm
		3/8" 7/16" 1/2" 9/16" 11/16" 3/4" 13/16" 7/8"
Regular socket	1/2" drive 6 point	17, 24, 27, 32mm
		11/16" 3/4" 13/16" 7/8" 1" 1 1/16"
Spark plug sockets	3/8" drive 6 point	16, 21mm
Bits	5/16" hex coupler adaptor	3mm hex, 4mm hex, 5mm hex, 6mm hex, 7mm hex, 10mm hex, 1/8" hex, 9/64" hex, 5/32" hex, 3/16" hex, 1/4" hex, 5/16" hex, TX10, TX15, TX20, TX25, TX30, TX40, 4mm, 5.5mm, 7mm flat, PH1, PH2, PH3, PZ1, PZ2, PZ3
Bits	5/16" hex	TX45, TX50

TM127 1/4", 3/8" and 1/2" Drive Metric and AF Socket and Tool Set

127 piece 1/4", 3/8" and 1/2" drive socket set containing regular and deep 1/4" drive sockets, 3/8" and 1/2" drive regular sockets, FRP ratchets, extension bars, universal joints, spark plug sockets, adaptors and screwdriver bits. The set also includes combination spanners, an adjustable wrench and a ratcheting bits driver. Supplied in a plastic carrying case with latch lid, retractable handle and metal pin hinges. The underside of the case is fitted with rubber feet to prevent it from sliding. (466x258x105mm, 7.5 kilos)

Accessories	1/4" drive		FRP ratchet, universal joint, 2" and 3" extension bars, coupler adaptor
Regular sockets	1/4" drive	6 point	4, 5, 5.5, 6, 7, 8, 10, 11, 12, 13mm
		6 point	3/16", 7/32", 1/4", 9/32", 5/16", 11/32", 3/8", 7/16", 1/2"
Deep sockets	1/4" drive	6 point	6, 7, 8, 10, 12, 13mm
Accessories	3/8" drive		FRP ratchet, universal joint, 3" and 6" extension bars, coupler adaptor, 16 and 21mm spark plug sockets, 3/8"F:1/4"M adaptor, 3/8"F:1/2"M adaptor
Regular sockets	3/8" drive	6 point	8, 9, 10, 11, 12, 13, 14, 15, 16, 17, 18, 19, 21, 22mm
		6 point	5/16", 3/8", 7/16", 1/2", 9/16", 5/8", 11/16", 3/4", 13/16", 7/8"
Accessories	1/2" drive		2 1/2" and 10" extension bars, flex head adaptor, 1/2"F:3/8"M adaptor
Regular sockets	1/2" drive	12 point	19, 24, 27, 30, 32mm
Wrenches			8, 9, 10, 11, 12, 13, 14, 15, 16, 17, 18, 19mm combination spanners, spanner ring, 8" adjustable wrench
Bits	1/4" hex		Ratcheting bits driver, 4mm (x 2), 5.5mm (x 2) and 7mm flat (x 2), PH0, PH1 (x 2) PH2 (x 2), PH3, PZ1 (x 2), PZ2 (x 2), PZ3, 1/4"M adaptor, 3, 4, 5, 6, 8, 10mm hex, 1/8", 9/64", 5/32", 3/16", 1/4", 3/8" hex, TX8, TX10, TX15, TX20, TX25, TX27, TX30, TX40, 5 and 6 XZN.



TT3819 3/8" drive socket set

Set containing 13 regular 6 point sockets, ratchet handle, universal joint, 3" wobble extension bar, 10" spinner handle with 3/8" drive at both ends, 1/2"-3/8" adaptor and 1/4" coupler adaptor. Supplied in the unique Teng Tools TC tray with removable lid and dove tail joints for use on it's own or as part of the Teng Tools TC control system. (265x142x50mm, 1.0 kilos)

Accessories	3/8" drive		Ratchet, universal joint, 3" wobble extension, 10" rotating spinner handle, 1/2" F:3/8" M T bar adaptor, coupler adaptor
Regular sockets	3/8" drive	6 point	8, 9, 10, 11, 12, 13, 14, 15, 16, 17, 18, 19, 22mm



TT3816 3/8" drive deep sockets

Set containing 16 deep 6 point sockets 3/8" drive. Supplied in the unique Teng Tools TC tray with removable lid and dove tail joints for use on it's own or as part of the Teng Tools TC control system. (265x142x50mm, 1.5 kilos)

Deep sockets	3/8" drive	6 point	7, 8, 9, 10, 11, 12, 13, 14, 15, 16, 17, 18, 19, 20, 21, 22mm
--------------	------------	---------	---



TTAF32 1/4" & 3/8" AF socket set

Set containing 1/4" and 3/8" drive 6 point sockets, regular and deep. Supplied in the unique Teng Tools TC tray with removable lid and dove tail joints for use on it's own or as part of the Teng Tools TC control system. (265x142x50mm, 1.36 kilos)

Regular sockets	1/4" drive	6 point	3/16" 7/32" 1/4" 9/32" 5/16" 11/32" 3/8" 7/16" 1/2"
Deep sockets	1/4" drive	6 point	3/16" 7/32" 1/4" 9/32" 5/16" 11/32" 3/16" 3/8" 7/16" 1/2"
Regular sockets	3/8" drive	6 point	3/8" 7/16" 1/2" 9/16" 5/8" 11/16" 3/4"
Deep sockets	3/8" drive	6 point	3/8" 7/16" 1/2" 9/16" 5/8" 11/16" 3/4"



TTTX30 3/8" drive TX/TPX/TXE socket set

30 piece 3/8" drive bit socket set containing 28 TX, TPX and TX-E socket bits for internal and external heads plus 3/8" - 1/4" adaptor, and 3" extension bar 3/8" drive. Supplied in the unique Teng Tools TC tray with removable lid and dove tail joints for use on it's own or as part of the Teng Tools TC control system. (265x142x50mm, 1.1 kilos)

Accessories	3/8" drive		3" extension, 3/8"F:1/4"M adaptor
TX bit sockets	3/8" drive		TX10, 15, 20, 25, 27, 30, 40, 45, 50
TPX bit sockets	3/8" drive		TPX10, 15, 20, 25, 27, 30, 40, 45, 50
TX-E sockets	1/4" drive		E4, E5, E6, E7, E8
	3/8" drive		E10, E12, E14, E16, E18



TTBS35 1/4" & 3/8" drive bit socket set

35 piece 1/4" and 3/8" drive set containing 33 bits for hex, TX, PH, PZ and flat type, plus 2 adaptors. Supplied in the unique Teng Tools TC tray with removable lid and dove tail joints for use on it's own or as part of the Teng Tools TC control system. (265x142x50mm, 1.25 kilos)

Bits sockets	1/4" drive		PH0, PH1, PH2, PH3, PZ1, PZ2, PZ3, 4mm flat, 4.5mm flat, 7mm flat, TX10, TX15, TX20, TX25, TX27, TX30, TX40
Hex bit sockets	3/8" drive metric		3, 4, 5, 5.5, 6, 7, 8, 10, 12mm
Hex bit sockets	3/8" drive AF		1/8" 5/32" 3/16" 7/32", 1/4" 5/16" 3/8"
Accessories			1/4"F:3/8"M adaptor, 3/8"F:1/4"M adaptor



TTXTB05 3/8" drive extra long swivel spark plug set

5 piece set with 3/8" drive extra long swivelling spark plug sockets and a T bar with handle. Supplied in the unique Teng Tools drawer width TTX tray for use on it's own or as part of the Teng Tools TC control system. (570x115x70mm, 6.5 kilos)

Spark plug sockets	14, 16, 21mm
Accessories	2 piece T bar handle



TTXTB09 3/8" drive extra long socket set

9 piece set with 3/8" drive sockets and a T bar with handle. Supplied in the unique Teng Tools drawer width TTX tray for use on it's own or as part of the Teng Tools TC control system. (570x115x70mm, 6.5 kilos)

Extra long sockets	8, 10, 12, 13, 14, 17, 19mm
Accessories	2 piece T bar handle



TED3836 3/8" Drive Socket Set

Set containing 3/8" drive regular and bit sockets and a range of accessories. Supplied in the unique Teng Tools double width TC tray with removable lid and dove tail joints for use on it's own or as part of the Teng Tools TC control system. The tools are held in place using the Teng Tools three colour pre-cut EVA foam tool control system. (265x284x50mm, 2.49 kilos)



Accessories	3/8" drive	72 teeth ratchet, rotating spinner handle, 3" extension bar, universal joint, 1/2" F:3/8" M adaptor
Regular sockets	3/8" drive 6 point	8, 9, 10, 11, 12, 13, 14, 15, 16, 17, 18, 19, 22mm
Bit sockets	3/8" drive	TX10, TX15, TX20, TX25, TX27, TX30, TX40, TX45, TX50, 3, 4, 5, 5.5, 6, 7, 8, 10, 12mm hex

TTESK86 1/4" & 3/8" drive socket set

Set containing 1/4" and 3/8" drive regular and deep metric sockets and a comprehensive range of accessories. Supplied in the Teng Tools three colour pre-cut EVA foam tool control system. (570x375x75mm, 6.55 kilos)



Accessories	1/4" drive	72 teeth ratchet, 6" spinner handle, 2" 3" 4" 6" and 12" extension bars, universal joint, 1/4" F:3/8" M adaptor, sliding T bar, coupler adaptor, T-HD T bar handle adaptor
Regular sockets	1/4" drive 6 point	4, 4.5, 5, 5.5, 6, 7, 8, 9, 10, 11, 12, 13mm
Deep sockets	1/4" drive 6 point	4, 5, 5.5, 6, 7, 8, 9, 10, 11, 12, 13mm
Accessories	3/8" drive	72 teeth ratchet, speed brace, spinner handle, 3", 5", 6", 10" and 20" extension bars, universal joint, 3/8" F:1/4" M adaptor, 3/8" F:1/2" M adaptor, 16mm, 18mm and 21mm spark plug sockets, coupler adaptor, 10" rotating spinner handle.
Regular sockets	3/8" drive 6 point	7, 8, 9, 10, 11, 12, 13, 14, 15, 16, 17, 18, 19, 20, 21 and 22mm
Deep sockets	3/8" drive 6 point	7, 8, 9, 10, 11, 12, 13, 14, 15, 16, 17, 18, 19, 20, 21 and 22mm

TTESK77 1/4" 3/8" 1/2" drive socket set

76 piece 1/4", 3/8" and 1/2" drive socket set containing 1/4", 3/8" and 1/2" drive sockets and accessories. Covers all the popular sizes from 4 to 24mm with selected sizes in deep and a range of 1/2" drive impact sockets. Supplied in the Teng Tools three colour pre-cut EVA foam tool control system. (570x375x50mm, 7.2 kilos)

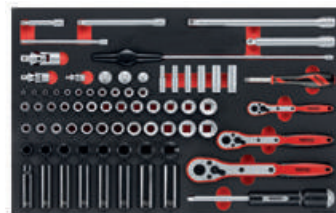

Accessories	1/4" drive	FRP ratchet, 6" spinner handle, 6" and 12" extension bars, universal joint, T-bar and T-bar handle adaptor.
Regular Sockets	1/4" drive 6 point	4, 5, 5.5, 6, 7, 8, 9, 10, 11, 12, 13mm
Deep Sockets	1/4" drive 6 point	7, 8, 10, 12, 13mm
Accessories	3/8" drive	FRP ratchet, 3" wobble extension bar, 6" extension bar, universal joint, 3/8" F:1/4" M adaptor, 3/8" F:1/2" M adaptor, rotating spinner handle.
Regular Sockets	3/8" drive 6 point	8, 9, 10, 11, 12, 13, 14, 15, 16, 17, 18, 19, 22mm.
Accessories	1/2" drive	FRP ratchet, 6" wobble extension bar, 10" extension bar, universal joint, 1/2" F:3/8" M adaptor.
Regular Sockets	1/2" drive 6 point	10, 11, 12, 13, 14, 15, 16, 17, 18, 19, 22mm
Impact Sockets	1/2" drive regular 6 point	13, 15, 16, 17, 18, 19, 22, 24mm
Impact Sockets	1/2" drive deep 6 point	13, 15, 16, 17, 18, 19, 22, 24mm

TTESK85 85 Piece 1/4" 3/8" 1/2" drive socket set

85 piece socket bit set containing 1/4", 3/8" and 1/2" drive bit sockets. Covers all the popular types and sizes including screwdriver type, hex bits, TX and TPX, XZN. Supplied in the Teng Tools three colour pre-cut EVA foam tool control system. (570x375x50mm, 4.5 kilos)

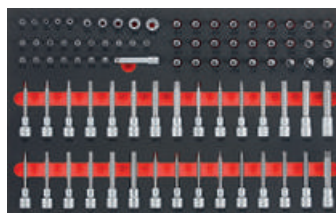

Flat bit sockets	1/4" drive 4, 5.5, 7mm	PH bit sockets	1/4" drive PH0, PH1, PH2, PH3
PZ bit sockets	1/4" drive PZ1, PZ2, PZ3	TX-E sockets	1/4" drive E4, E5, E6, E7, E8
TX bit sockets	1/4" drive TX10, TX15, TX20, TX25, TX27, TX30, TX40	Accessories	3/8" drive 3" extension bar
TX-E sockets	3/8" drive E10, E12, E14, E16, E18	TX bit sockets	3/8" drive TX10, TX15, TX20, TX25, TX27, TX30, TX40, TX45, TX50
TPX bit sockets	3/8" drive TPX10, TPX15, TPX20, TPX25, TPX27, TPX30, TPX40, TPX45, TPX50	Hex bit sockets	1/2" drive 3, 4, 5.5, 6, 7, 8, 10, 12mm
TX bit sockets	1/2" drive TX20, TX25, TX27, TX30, TX40, TX45, TX50, TX55, TX60	Hex bit sockets	1/2" drive 5, 6, 7, 8, 10, 12mm
Ribe bit sockets	1/2" drive 4, 5, 6, 8, 10, 11, 12, 13	XZN bit sockets	1/2" drive 5, 6, 8, 10, 12, 14, 16

M3816 3/8" Drive regular sockets

16 piece 3/8" drive regular metric 6 point sockets supplied on a clip rail. Chrome vanadium steel. Satin finish.

Accessories	1 clip rail (370mm in length) complete with 16 3/8" drive socket clips
Regular sockets	3/8" drive 6 point 7, 8, 9, 10, 11, 12, 13, 14, 15, 16, 17, 18, 19, 20, 21, 22mm



M3807 3/8" Drive deep sockets

7 piece 3/8" drive deep metric 6 point sockets supplied on a clip rail. Chrome vanadium steel. Satin finish.

Accessories	1 clip rail (165mm in length) complete with 7 3/8" drive socket clips
Deep sockets	3/8" drive 6 point 10, 12, 13, 14, 15, 17, 19mm



M3811 3/8" Drive AF hex bit sockets

8 piece 3/8" drive AF hex bit sockets supplied on a clip rail. Chrome vanadium sockets for internal hex holes.



Accessories	1 clip rail (165mm in length) complete with 8 3/8" drive socket clips
AF hex bit sockets	3/8" drive 3/32" 1/8" 5/32" 3/16" 7/32" 1/4" 5/16" 3/8"



M3812 3/8" Drive hex bit sockets

9 piece 3/8" drive metric hex bit socket supplied on a clip rail. Chrome vanadium sockets for internal hex holes.



Accessories	1 clip rail (165mm in length) complete with 9 3/8" drive socket clips
Metric hex bit sockets	3/8" drive 3, 4, 5, 5.5, 6, 7, 8, 10, 12mm



M3813TPX 3/8" Drive TPX bit sockets

9 piece 3/8" drive TPX sockets supplied on a clip rail for internal tamper TPX heads.



Accessories	1 clip rail (165mm in length) complete with 9 3/8" drive socket clips
TPX bit sockets	3/8" drive TPX10, TPX15, TPX20, TPX 25, TPX27, TPX30, TPX 40, TPX45, TPX50



M3813TX 3/8" Drive TX bit sockets

9 piece 3/8" drive TX sockets supplied on a clip rail for internal TX heads.



Accessories	1 clip rail (165mm in length) complete with 9 3/8" drive socket clips
TX bit sockets	3/8" drive TX10, TX15, TX20, TX25, TX27, TX30, TX40, TX45, TX50



M3814 1/4" & 3/8" Drive TX-E sockets

10 piece 1/4" and 3/8" drive TX-E sockets supplied on a clip rail. Chrome vanadium steel. Satin finish.



Accessories	1 clip rail (165mm in length) complete with 5 1/4" drive and 5 3/8" drive socket clips
TX-E sockets	1/4" drive E4, E5, E6, E7, E8
TX-E sockets	3/8" drive E10, E12, E14, E16, E18



1/2" Drive Socket Sets

M1212N1 12 Piece 1/2" Drive Socket Set

A basic no-nonsense 1/2" drive set of sockets with the FRP ratchet and an extension bar. Supplied in the Teng Tools clip box which stores the sockets and includes a clip rail facility for adding extra sockets.



Accessories	1/2" drive	FRP ratchet, 5" extension bar
Regular sockets	1/2" drive	8, 10, 12, 13, 14, 15, 17, 18, 19, 24mm

T1220AF 20 Piece 1/2" Drive AF Socket Set

20 piece 1/2" drive socket set containing 12 point regular AF sockets, 2 1/2" and 6" extension bars, universal joint, 1/2"-3/8" adaptor as well as a FRP ratchet. Supplied in a plastic carrying case with latch lid, retractable handle and metal pin hinges. The underside of the case is fitted with rubber feet to prevent it from sliding. (369x198x62mm, 3.0 kilos)



Accessories	1/2" drive	FRP ratchet, universal joint, 2 1/2" and 6" extensions, 3/8" F:1/2" M T-bar adaptor
Regular sockets	1/2" drive	12 point 3/8" 7/16" 1/2" 9/16" 5/8" 11/16" 3/4" 13/16" 7/8" 15/16" 1" 1 1/16" 1 1/8" 1 1/4" 1 1/2"

T1221 21 Piece 1/2" Drive Socket Set

21 piece 1/2" drive socket set containing 12 point regular sockets, 2 1/2" and 6" extension bars, universal joint, 1/2"-3/8" adaptor as well as a FRP ratchet. Supplied in a plastic carrying case with latch lid, retractable handle and metal pin hinges. The underside of the case is fitted with rubber feet to prevent it from sliding. (369x198x62mm, 3.1 kilos)



Accessories	1/2" drive	FRP ratchet, universal joint, 2 1/2" and 6" extensions, 3/8" F:1/2" M T-bar adaptor
Regular sockets	1/2" drive	12 point 10, 11, 12, 13, 14, 15, 16, 17, 18, 19, 21, 22, 24, 27, 30, 32mm

T1221-6 21 Piece 1/2" Drive Socket Set

21 piece 1/2" drive socket set containing 6 point regular sockets, 2 1/2" and 6" extension bars, universal joint, 1/2"-3/8" adaptor as well as a FRP ratchet. Supplied in a plastic carrying case with latch lid, retractable handle and metal pin hinges. The underside of the case is fitted with rubber feet to prevent it from sliding. (369x198x62mm, 3.1 kilos)



Accessories	1/2" drive	FRP ratchet, universal joint, 2 1/2" and 6" extensions, 3/8" F:1/2" M T-bar adaptor
Regular sockets	1/2" drive	6 point 10, 11, 12, 13, 14, 15, 16, 17, 18, 19, 21, 22, 24, 27, 30, 32mm

T1230 30 Piece 1/2" Drive Socket Set

30 piece 1/2" drive socket set containing 12 point regular metric and AF sockets, 3" extension bar, universal joint, 3/8"-1/2" adaptor as well as a FRP ratchet. Supplied in a plastic carrying case with latch lid, retractable handle and metal pin hinges. The underside of the case is fitted with rubber feet to prevent it from sliding. (369x198x62mm, 3.6 kilos)



Accessories	1/2" drive	FRP ratchet handle, 5" extension bar, universal joint, 3/8" F:1/2" M adaptor
Regular sockets	MM 1/2" drive	12 point 10, 12, 13, 14, 15, 16, 17, 18, 19, 21, 22, 24, 27, 30, 32mm
Regular sockets	AF 1/2" drive	12 point 3/8" 7/16" 1/2" 9/16" 5/8" 3/4" 13/16" 15/16" 1" 1 1/16" 1 1/8" 1 1/4"

T1234 34 Piece 1/2" Drive Socket Set

34 piece 1/2" drive socket set containing 6 point regular and deep metric sockets, FRP ratchet, extension bars, universal joint, T bar adaptor and spark plug sockets. Supplied in a plastic carrying case with latch lid, retractable handle and metal pin hinges. The underside of the case is fitted with rubber feet to prevent it from sliding. (480x248x68mm, 5.4 kilos)



Accessories	1/2" drive	FRP ratchet handle, 5" and 10" extension bars, universal joint, 3/8" F:1/2" M adaptor
Regular sockets	1/2" drive	6 point 10, 11, 12, 13, 14, 15, 16, 17, 18, 19, 20, 21, 22, 23, 24, 27mm
Deep sockets	1/2" drive	6 point 13, 14, 15, 16, 17, 18, 19, 24mm
Spark plug sockets	1/2" drive	6 point 16, 21mm
Hexagon keys		1.5, 2.0, 2.5mm

T1268 1/2" Drive Tool Set

68 piece 1/2" drive tool set, containing 16 regular 12 point metric sockets, FRP ratchet, universal joint, 2 1/2" and 6" extension bars, adaptor 3/8" F -1/2" M, bits holder with magnetic bits holder, 10 combination spanners, 6 screwdrivers, 4 pliers as well as 26 bits. Supplied in a plastic carrying case with latch lid, retractable handle and metal pin hinges. The underside of the case is fitted with rubber feet to prevent it from sliding. (466x258x103mm, 6.72 kilos)



Accessories	1/2" drive	FRP ratchet, 2 1/2" & 6" extensions, universal joint, 1/2" F:3/8" M T-bar adaptor, bits driver handle with magnetic bits holder
Regular sockets	1/2" drive	12 point 10, 11, 12, 13, 14, 15, 16, 17, 18, 19, 21, 22, 27, 30, 32mm
Combination spanners		8, 10, 11, 12, 13, 14, 15, 16, 17, 19mm
Screwdrivers		3.0mm flat, 5.5mm flat, 6.6mm flat, PH0, PH1, PH2,
Pliers		6" side cutter, 7" combination, 8" long nose, 10" water pump
Bits 25mm	1/4" hex	TX8, TX10, TX15, TX20, TX25, TX27, TX30, TX40, TX45, TX50, 3mm hex, 4mm hex, 5mm hex, 6mm hex, 8mm hex, PH0, PH1, PH2, PH3, PZ1, PZ2, PZ3, 4mm flat, 5.5mm flat, 7mm flat

T1272 72 Piece 1/4" & 1/2" Socket Set

72 piece socket set containing 1/4" and 1/2" drive regular sockets and accessories together with a comprehensive range of socket accessories. Supplied in a plastic carrying case with latch lid, retractable handle and metal pin hinges. The underside of the case is fitted with rubber feet to prevent it from sliding. (480x248x68mm, 4.6 kilos)



Accessories	1/4" drive	FRP ratchet, bi-flex wrench, 4" extension bar, coupler adaptor
Accessories	1/2" drive	FRP ratchet, 5" & 10" extension bars, 3/8" F:1/2" M T bar adaptor, flex head adaptor, universal joint
Regular sockets	1/4" drive 6 point	4, 5, 5.5, 6, 7, 8, 10, 11, 12, 13mm
Regular sockets	1/2" drive 12 point	10, 11, 12, 13, 14, 15, 16, 17, 18, 19, 20, 21, 22, 23, 24, 27mm
Bits	1/4" hex	TX8, TX10, TX15, TX20, TX25, TX27, TX30, TX40, 3mm hex, 4mm hex, 5mm hex, 6mm hex, 8mm hex, 10mm hex, 1/8" hex, 9/64" hex, 5/32 hex, 3/16" hex, 7/32" hex, 1/4" hex, 3/8" hex, PH0, PH1, PH2, PH3, PZ1, PZ2, PZ3, 4mm flat, 5.5mm flat, 7mm flat, XZN M5, XZN M6
Hex keys		1.5, 2.0, 2.5mm

TM095 1/4" and 1/2" Drive Socket and Tool Set

95 piece 1/4" and 1/2" drive socket set containing regular and deep 1/4" drive metric sockets, 1/2" drive regular 6 point sockets, FRP ratchets, universal joints, extension bars, 1/2" drive spark plug sockets and other socket accessories and screwdriver bits. The set also includes combination spanners and screwdrivers. Supplied in a plastic carrying case with latch lid, retractable handle and metal pin hinges. The underside of the case is fitted with rubber feet to prevent it from sliding. (466x258x103mm, 6.3 kilos)

Accessories	1/4" drive	FRP ratchet, universal joint, 2" and 4" extensions, sliding T bar, spinner handle, coupler adaptor, 50mm magnetic bit holder
Regular sockets	1/4" drive 6 point	4, 4.5, 5, 5.5, 6, 7, 8, 9, 10, 11, 12, 13mm
Deep sockets	1/4" drive 6 point	4, 5, 6, 7, 8, 9, 10, 11, 12, 13mm
Regular sockets	1/2" drive 6 point	10, 11, 12, 13, 14, 15, 17, 19, 22, 24, 27, 30, 32mm
Accessories	1/2" drive	FRP ratchet, 5" and 10" extensions, 3/8" F:1/2" M T bar adaptor, universal joint, 5/16" hex coupler adaptor, 21mm spark plug socket
Combination spanners		8, 10, 12, 13, 14, 17mm
Screwdrivers		PH1x75mm, PH2x100mm, PZ1x75mm, PZ2x100mm, 3mm flat x 75mm, 4mm flat x 100mm
Bits (25mm)	1/4" hex	4, 5.5 and 7mm flat, PH0, PH1, PH2, PH3, PH4, PZ0, PZ1, PZ2, PZ3, 3, 4, 5, 6, 8 and 10mm hexagon, 1/4" male adaptor, TX8, TX10, TX15, TX20, TX25, TX27, TX30, TX40
Bits (30mm)	5/16" hex	TX45, TX50, TX55



TM106 106 Piece 1/4" 3/8" & 1/2" Drive Socket Set

106 piece professional tool set, containing 1/4" and 3/8" drive regular 6 point sockets, 1/4" drive deep sockets, 3/8" drive spark plug sockets, 1/2" drive regular 12 point sockets, FRP ratchets, universal joints coupler adaptors, extension bars, bi-flex wrench, bit driver, adaptors, double flex wrenches, combination spanners, ring holder, adjustable wrench and a full range of screwdriver bits. Supplied in a plastic carrying case with latch lid, retractable handle and metal pin hinges. The underside of the case is fitted with rubber feet to prevent it from sliding. (466x258x103mm, 7.85 kilos)



Accessories	1/4" drive	FRP ratchet, bi-flex wrench, universal joint, 2" & 3" extensions, coupler adaptor, bits driver handle with magnetic bits holder
Accessories	3/8" drive	FRP ratchet, 3" & 6" extensions, universal joint, 3/8" F:1/4" M T bar adaptor, 3/8" F:1/2" M T bar adaptor, coupler adaptor
Accessories	1/2" drive	2 1/2" & 10" extensions, 1/2" F:3/8" M T bar adaptor, flex head adaptor
Regular sockets	1/4" drive 6 point	4, 5, 6, 7, 8, 10, 12, 13mm
Deep sockets	1/4" drive 6 point	6, 7, 8, 10, 12, 13mm
Regular sockets	3/8" drive 6 point	8, 9, 10, 12, 13, 14, 15, 16, 17, 18, 19, 21, 22mm
Spark plug sockets	3/8" drive	16, 21mm
Regular sockets	1/2" drive 12 point	19, 24, 27, 30, 32mm
Bits (25mm)	1/4" hex	TX8, TX10, TX15, TX20, TX25, TX27, TX30, TX40, TPX10, TPX15, TPX25, TPX27, TPX30, TPX40 3mm hex, 4mm hex, 5mm, 6mm hex, 8mm hex, 10mm hex, PH0, PH1, PH2, PH3, PZ1, PZ2, PZ3, 4mm flat, 5.5mm flat, 7mm flat, XZN M5, XZN M6
Wrenches		8, 9, 10, 11, 12, 13, 14, 15, 16, 17, 18, 19mm combination spanners, ring holder, 8x9mm, 10x11mm, 12x13mm, 14x15mm double flex wrenches, 10" adjustable

TM111 111 Piece Socket Set

111 piece socket set containing 1/4", 3/8" and 1/2" drive regular sockets and accessories, 3/8" drive deep sockets, spark plug sockets plus 1/4" and 5/16" hex bits. Supplied in a plastic carrying case with latch lid, retractable handle and metal pin hinges. The underside of the case is fitted with rubber feet to prevent it from sliding. (466x258x103mm, 8.1 kilos)



Accessories	1/4" drive	FRP ratchet, 5/16" hex coupler adaptor, 6" flexible extension, 2" and 4" extension bars, spinner handle, universal joint, 1/4" Fx3/8" M adaptor, 4" T bar
Accessories	3/8" drive	FRP ratchet, bits holder 1/4" hex, 3" and 6" extension bars, spinner handle, universal joint, 3/8" Fx1/2" M adaptor, spin disc
Accessories	1/2" drive	FRP ratchet, 5/16" hex coupler, 2 1/2" and 10" extension bars, 1/2" Fx3/8" M adaptor, spin disc
Regular sockets	1/4" drive 6 point	4, 5, 6, 7, 8, 10, 12mm
Regular sockets	3/8" drive 6 point	3/16" 7/32" 1/4" 9/32" 3/8" 7/16"
Deep sockets	3/8" drive 6 point	8, 9, 10, 12, 13, 14, 15, 16, 17mm
		3/8" 7/16" 1/2" 9/16" 11/16" 3/4" 13/16" 7/8"
Deep sockets	3/8" drive 6 point	8, 9, 10, 12, 13, 14, 15, 16, 17mm
		3/8" 7/16" 1/2" 9/16" 11/16" 3/4" 13/16" 7/8"
Regular socket	1/2" drive 6 point	17, 24, 27, 32mm
		11/16" 3/4" 13/16" 7/8" 1" 1 1/16"
Spark plug sockets	3/8" drive 6 point	16, 21mm
Bits	5/16" hex coupler adaptor	3mm hex, 4mm hex, 5mm hex, 6mm hex, 7mm hex, 10mm hex, 1/8" hex, 9/64" hex, 5/32" hex, 3/16" hex, 1/4" hex, 5/16" hex, TX10, TX15, TX20, TX25, TX30, TX40, 4mm, 5.5mm, 7mm flat, PH1, PH2, PH3, PZ1, PZ2, PZ3
Bits	5/16" hex	TX45, TX50

TM127 1/4", 3/8" and 1/2" Drive Metric and AF Socket and Tool Set

127 piece 1/4", 3/8" and 1/2" drive socket set containing regular and deep 1/4" drive sockets, 3/8" and 1/2" drive regular sockets, FRP ratchets, extension bars, universal joints, spark plug sockets, adaptors and screwdriver bits. The set also includes combination spanners, an adjustable wrench and a ratcheting bits driver. Supplied in a plastic carrying case with latch lid, retractable handle and metal pin hinges. The underside of the case is fitted with rubber feet to prevent it from sliding. (466x258x105mm, 7.5 kilos)



Accessories	1/4" drive	FRP ratchet, universal joint, 2" and 3" extension bars, coupler adaptor
Regular sockets	1/4" drive 6 point	4, 5, 5.5, 6, 7, 8, 10, 11, 12, 13mm
	6 point	3/16", 7/32", 1/4", 9/32", 5/16", 11/32", 3/8", 7/16", 1/2"
Deep sockets	1/4" drive 6 point	6, 7, 8, 10, 12, 13mm
Accessories	3/8" drive	FRP ratchet, universal joint, 3" and 6" extension bars, coupler adaptor, 16 and 21mm spark plug sockets,
Regular sockets	3/8" drive 6 point	8, 9, 10, 11, 12, 13, 14, 15, 16, 17, 18, 19, 21, 22mm
	6 point	5/16", 3/8", 7/16", 1/2", 9/16", 5/8", 11/16", 3/4", 13/16", 7/8"
Accessories	1/2" drive	2 1/2" and 10" extension bars, flex head adaptor, 1/2" F:3/8" M adaptor
Regular sockets	1/2" drive 12 point	19, 24, 27, 30, 32mm
Wrenches		8, 9, 10, 11, 12, 13, 14, 15, 16, 17, 18, 19mm combination spanners, spanner ring, 8" adjustable wrench
Bits	1/4" hex	Ratcheting bits driver, 4mm (x 2), 5.5mm (x 2) and 7mm flat (x 2), PH0, PH1 (x 2) PH2 (x 2), PH3, PZ1 (x 2), PZ2 (x 2), PZ3, 1/4" M adaptor, 3, 4, 5, 6, 8, 10mm hex, 1/8", 9/64", 5/32", 3/16", 1/4", 3/8" hex, TX8, TX10, TX15, TX20, TX25, TX27, TX30, TX40, 5 and 6 XZN.

TT1205 1/2" drive ratchet & accessories

1/2" drive accessories set containing ratchet handle with quick release and twist reverse. Also includes universal joint and 5" and 10" extensions. Supplied in the unique Teng Tools TC tray with removable lid and dove tail joints for use on it's own or as part of the Teng Tools TC control system. (265x142x50mm, 1.1 kilos)

Accessories	1/2" drive Ratchet, universal joint, 5" and 10" extensions, 3/8" F:1/2" M T bar adaptor
-------------	---



TT1211 1/2" drive deep socket set

Set containing 10 12 point deep 1/2" drive sockets and 10" flex handle. Supplied in the unique Teng Tools TC tray with removable lid and dove tail joints for use on it's own or as part of the Teng Tools TC control system. (265x142x50mm, 2.0 kilos)

Accessories	1/2" drive	10" flex handle	
Deep sockets	1/2" drive	12 point	10, 11, 12, 13, 14, 15, 16, 17, 18, 19mm



TT1217 1/2" drive socket set (12 point)

Socket set containing 12 point sockets. Supplied in the unique Teng Tools TC tray with removable lid and dove tail joints for use on it's own or as part of the Teng Tools TC control system. (265x142x50mm, 1.8 kilos)

Regular sockets	1/2" drive	12 point	10, 11, 12, 13, 14, 15, 16, 17, 18, 19, 20, 21, 22, 24, 27, 30, 32mm
-----------------	------------	----------	--



TT1217-6 1/2" drive socket set (6 point)

Socket set containing 6 point sockets. Supplied in the unique Teng Tools TC tray with removable lid and dove tail joints for use on it's own or as part of the Teng Tools TC control system. (265x142x50mm, 1.8 kilos)

Regular sockets	1/2" drive	6 point	10, 11, 12, 13, 14, 15, 16, 17, 18, 19, 20, 21, 22, 24, 27, 30, 32mm
-----------------	------------	---------	--



TT1218 1/2" drive socket set (12 point)

17 piece metric socket set containing 12 point sockets. Also contains ratchet handle with quick release and twist reverse, 2 1/2" and 6" extension bars, 3/8-1/2" adaptor as well as a universal joint. Supplied in the unique Teng Tools TC tray with removable lid and dove tail joints for use on it's own or as part of the Teng Tools TC control system. (265x142x50mm, 2.2 kilos)

Accessories	1/2" drive	Ratchet, universal joint, 2 1/2" and 6" extensions, 3/8" F:1/2" M T bar adaptor	
Regular sockets	1/2" drive	12 point	10, 11, 12, 13, 14, 15, 16, 17, 18, 19, 22, 24mm



TT1218-6 1/2" drive socket set (6 point)

17 piece metric socket set containing 6 point sockets. Also contains ratchet handle with quick release and twist reverse, 2 1/2" and 6" extension bars, 3/8-1/2" adaptor as well as a universal joint. Supplied in the unique Teng Tools TC tray with removable lid and dove tail joints for use on it's own or as part of the Teng Tools TC control system. (265x142x50mm, 2.2 kilos)

Accessories	1/2" drive	Ratchet, universal joint, 2 1/2" and 6" extensions, 3/8" F:1/2" M T bar adaptor	
Regular sockets	1/2" drive	6 point	10, 11, 12, 13, 14, 15, 16, 17, 18, 19, 22, 24mm



TT1215AF 1/2" Drive AF socket set

Socket set containing 15 regular AF 12 point sockets. Supplied in the unique Teng Tools TC tray with removable lid and dove tail joints for use on it's own or as part of the Teng Tools TC control system. (265x142x50mm, 1.7 kilos)

Regular sockets	1/2" drive	12 point	3/8" 7/16" 1/2" 9/16" 5/8" 11/16" 3/4" 13/16" 7/8" 15/16" 1" 1 1/8" 1 1/4" 1 3/8" 1 1/2"
-----------------	------------	----------	--



TTHEX16 1/2" drive hex bit socket set

Set containing 16 1/2" drive bit sockets for internal hex holes. Supplied in the unique Teng Tools TC tray with removable lid and dove tail joints for use on it's own or as part of the Teng Tools TC control system. (265x142x50mm, 1.5 kilos)

55mm	hex bit sockets	5, 6, 7, 8, 9, 10, 12, 14, 17mm
100mm	hex bit sockets	5, 6, 10, 12, 14, 17mm
115mm	hex bit sockets	8mm



TTHEX23 1/2" drive hex bit socket set

Set containing 20 bits, regular and long, for internal hex holes. Also includes 2 adaptors and a 2mm hex mini screwdriver for tightening the retaining grub screw in the adaptors. Supplied in the unique Teng Tools TC tray with removable lid and dove tail joints for use on it's own or as part of the Teng Tools TC control system. (265x142x50mm, 1.1 kilos)

Adaptors	1/2" drive	10mm hex bit adaptor, 12mm hex bit adaptor
Hex bits 40mm	10mm hex drive	5, 6, 7, 8, 9, 10mm
Hex bits 40mm	12mm hex drive	12, 14, 17, 19mm
Hex bits 75mm	10mm hex drive	5, 6, 7, 8, 9, 10mm
Hex bits 75mm	12mm hex drive	12, 14, 17, 19mm
Accessories		2mm hex mini screwdriver



TTTX18 1/2" drive TX bit socket set

Set containing 18 1/2" drive bit sockets for internal TX holes. Supplied in the unique Teng Tools TC tray with removable lid and dove tail joints for use on it's own or as part of the Teng Tools TC control system. (265x142x50mm, 1.5 kilos)

55mm TX bit sockets	TX20, TX25, TX27, TX30, TX40, TX45, TX50, TX55, TX60
110mm TX bit sockets	TX20, TX25, TX27, TX30, TX40, TX45, TX50, TX55, TX60



TTTX23 1/2" drive TX bit socket set

Set containing 20 bits, regular and long for internal TX heads. Also includes 2 adaptors and a 2mm hex mini screwdriver for tightening the retaining grub screws in the adaptors. Supplied in the unique Teng Tools TC tray with removable lid and dove tail joints for use on it's own or as part of the Teng Tools TC control system. (265x142x50mm, 1.1 kilos)

Adaptors	1/2" drive	10mm hex adaptor 12mm hex adaptor
Hex bits 40mm	10mm drive	TX20, 25, 27, 30, 40, 45, 50, 55
	12mm drive	TX60, 70
Hex bits 75mm	10mm drive	TX20, 25, 27, 30, 40, 45, 50, 55
	12mm drive	TX60, 70
Accessories		2mm hex mini screwdriver



TTRS15 1/2" Ribe & XZN socket set

Set containing 15 1/2" drive Ribe and XZN bit sockets with a satin finish. Supplied in the unique Teng Tools TC tray with removable lid and dove tail joints for use on it's own or as part of the Teng Tools TC control system. (265x142x50mm, 1.66 kilos)

Ribe bit sockets	100mm	No. 4, 5, 6, 8, 10, 11, 12, 13
XZN bit sockets	100mm	No. 5, 6, 8, 10, 12, 14, 16



TTTXH15 1/2" drive hex & TX bit socket set

15 piece set containing 100mm long bit sockets. 9 pieces for internal TX heads and 6 pieces for internal hex holes. Supplied in the unique Teng Tools TC tray with removable lid and dove tail joints for use on it's own or as part of the Teng Tools TC control system. (265x142x50mm, 1.40 kilos)

TX bit sockets	1/2" drive	TX20, TX25, TX27, TX30, TX40, TX45, TX50, TX55, TX60
Hex bit sockets	1/2" drive	5mm, 6mm, 7mm, 8mm, 10mm, 12mm



TED1227 1/2" Drive Socket Set

Set containing 1/2" drive regular and deep 12 point sockets and a range of accessories. Supplied in the unique Teng Tools double width TC tray with removable lid and dove tail joints for use on it's own or as part of the Teng Tools TC control system. The tools are held in place using the Teng Tools three colour pre-cut EVA foam tool control system. (265x284x50mm, 3.59 kilos)

Accessories	1/2" drive	72 teeth ratchet, 2 1/2" and 6" extension bars, universal joint, 3/8" F:1/2" M adaptor
Regular sockets	1/2" drive	12 point 10, 11, 12, 13, 14, 15, 16, 17, 18, 19, 22, 24mm
Deep sockets	1/2" drive	12 point 10, 11, 12, 13, 14, 15, 16, 17, 18, 19mm



TTESK63 1/2" drive socket set

Set containing 1/2" drive regular and deep metric sockets and a comprehensive range of accessories. Supplied in the Teng Tools three colour pre-cut EVA foam tool control system. (570x375x75mm, 11.03 kilos)

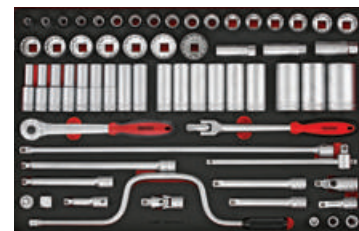

Accessories	1/2" drive	72 teeth ratchet, speed brace, sliding T bar, 2 1/2" 5" 6" and 20" extension bars, 3" 6" and 10" wobble extension bars, universal joint, 1/2" F:3/8" M T bar adaptor, 1/2" F:3/4" M adaptor, 16mm, 18mm, 21mm spark plug sockets, coupler adaptors for 5/16", 10mm and 12mm hex bits, flex head adaptor
Regular sockets	1/2" drive	12 point 8, 9, 10, 11, 12, 13, 14, 15, 16, 17, 18, 19, 20, 21, 22, 24, 25, 26, 27, 28, 29, 30, 32, 34mm
Deep sockets	1/2" drive	12 point 10, 11, 12, 13, 14, 15, 16, 17, 18, 19, 20, 21, 22, 24, 27, 30, 32, 36mm

TTESK77 1/4" 3/8" 1/2" drive socket set

76 piece 1/4", 3/8" and 1/2" drive socket set containing 1/4", 3/8" and 1/2" drive sockets and accessories. Covers all the popular sizes from 4 to 24mm with selected sizes in deep and a range of 1/2" drive impact sockets. Supplied in the Teng Tools three colour pre-cut EVA foam tool control system. (570x375x50mm, 7.2 kilos)

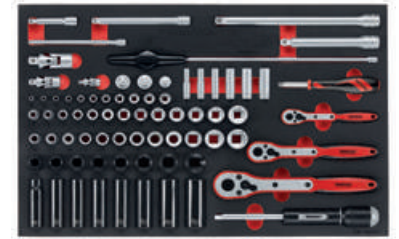

Accessories	1/4" drive	FRP ratchet, 6" spinner handle, 6" and 12" extension bars, universal joint, T-bar and T-bar handle adaptor.
Regular Sockets	1/4" drive	6 point 4, 5, 5.5, 6, 7, 8, 9, 10, 11, 12, 13mm
Deep Sockets	1/4" drive	6 point 7, 8, 10, 12, 13mm
Accessories	3/8" drive	FRP ratchet, 3" wobble extension bar, 6" extension bar, universal joint, 3/8" F:1/4" M adaptor, 3/8" F:1/2" M adaptor, rotating spinner handle.
Regular Sockets	3/8" drive	6 point 8, 9, 10, 11, 12, 13, 14, 15, 16, 17, 18, 19, 22mm.
Accessories	1/2" drive	FRP ratchet, 6" wobble extension bar, 10" extension bar, universal joint, 1/2" F:3/8" M adaptor.
Regular Sockets	1/2" drive	6 point 10, 11, 12, 13, 14, 15, 16, 17, 18, 19, 22mm
Impact Sockets	1/2" drive	regular 6 point 13, 15, 16, 17, 18, 19, 22, 24mm
Impact Sockets	1/2" drive	deep 6 point 13, 15, 16, 17, 18, 19, 22, 24mm

TTESK85 85 Piece 1/4" 3/8" 1/2" drive socket set

85 piece socket bit set containing 1/4", 3/8" and 1/2" drive bit sockets. Covers all the popular types and sizes including screwdriver type, hex bits, TX and TPX, Ribe and XZN. Supplied in the Teng Tools three colour pre-cut EVA foam tool control system. (570x375x50mm, 4.5 kilos)

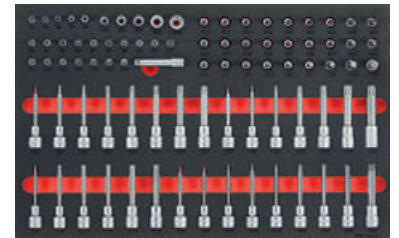

Flat bit sockets	1/4" drive	4, 5.5, 7mm	PH bit sockets	1/4" drive	PH0, PH1, PH2, PH3
PZ bit sockets	1/4" drive	PZ1, PZ2, PZ3	TX-E sockets	1/4" drive	E4, E5, E6, E7, E8
TX bit sockets	1/4" drive	TX10, TX15, TX20, TX25, TX27, TX30, TX40	Accessories	3/8" drive	3" extension bar
TX-E sockets	3/8" drive	E10, E12, E14, E16, E18	TX bit sockets	3/8" drive	TX10, TX15, TX20, TX25, TX27, TX30, TX40, TX45, TX50
TPX bit sockets	3/8" drive	TPX10, TPX15, TPX20, TPX25, TPX27, TPX30, TPX40, TPX45, TPX50	Hex bit sockets	1/2" drive	3, 4, 5.5, 6, 7, 8, 10, 12mm
TX bit sockets	1/2" drive	TX20, TX25, TX27, TX30, TX40, TX45, TX50, TX55, TX60	Hex bit sockets	1/2" drive	5, 6, 7, 8, 10, 12mm
Ribe bit sockets	1/2" drive	4, 5, 6, 8, 10, 11, 12, 13	XZN bit sockets	1/2" drive	5, 6, 8, 10, 12, 14, 16

M1215AF 1/2" Drive regular AF sockets

Set of 15 12 point AF sockets of chrome vanadium steel. Supplied on a clip rail with socket clips. Satin finish.

Accessories	1 clip rail (430mm in length) complete with 15 1/2" drive socket clips
Regular sockets	1/2" drive 12 point 3/8" 7/16" 1/2" 9/16" 5/8" 11/16" 3/4" 3/16" 7/8" 1 1/8" 1 1/16" 1 1/8" 1 1/4"



M1215MM 1/2" Drive regular sockets

Set of 15 12 point metric sockets of chrome vanadium steel. Supplied on a clip rail with socket clips. Satin finish.

Accessories	1 clip rail (430mm in length) complete with 15 1/2" drive socket clips
Regular sockets	1/2" drive 12 point 10, 12, 13, 14, 15, 16, 17, 18, 19, 21, 22, 24, 27, 30, 32mm



M1207 1/2" Drive deep 12 point sockets

Set of 8 deep 12 point metric sockets supplied on a clip rail. Chrome vanadium steel. Satin finish.

Accessories	1 clip rail (210mm in length) complete with 8 1/2" drive socket clips
Deep sockets	1/2" drive 12 point 13, 14, 15, 17, 19, 21, 22, 24mm



Socket Sets

M1208-6 1/2" Drive deep 6 point sockets

Set of 8 deep 6 point metric sockets supplied on a clip rail. Chrome vanadium steel. Satin finish.

Accessories	1 clip rail (210mm in length) complete with 8 1/2" drive socket clips
Deep sockets 1/2" drive 6 point	13, 14, 15, 16, 17, 18, 19, 24mm



M1210 1/2" Drive TX-E sockets

Set of 9 1/2" drive TX-E sockets supplied on a clip rail for external TX heads. Satin finish.

Accessories	1 clip rail (230mm in length) complete with 9 1/2" drive socket clips
TX-E sockets 1/2" drive	E10, E11, E12, E14, E16, E18, E20, E22, E24



M1212 1/2" Drive hex bit sockets

Set of 9 1/2" drive metric hex bit sockets for internal hex holes supplied on a clip rail. Satin finish.

Accessories	1 clip rail (220mm in length) complete with 9 1/2" drive socket clips
Hex bit sockets 1/2" drive	5, 6, 7, 8, 9, 10, 12, 14, 17mm



M1211 1/2" Drive hex bit sockets

Set of 6 100mm long 1/2" drive hex bit sockets supplied on a clip rail. Chrome vanadium. Satin finish.

Accessories	1 clip rail (160mm in length) complete with 6 1/2" drive socket clips
Hex bit sockets 1/2" drive	5, 6, 7, 8, 10, 12mm



M1209AF 1/2" Drive AF hex bit sockets

Set of 9 1/2" drive AF hex bit sockets for internal hex holes supplied on a clip rail. Satin finish.

Accessories	1 clip rail (220mm in length) complete with 9 1/2" drive socket clips
Hex bit sockets 1/2" drive	3/16", 7/32", 1/4", 9/32", 5/16", 3/8", 1/2", 9/16", 5/8"



Socket Sets

M1213TPX 1/2" Drive TPX bit sockets

Set of 9 1/2" drive TPX bit sockets for internal TPX heads (also for tamper proof screws) supplied on a clip rail. Satin finish.

Accessories	1 clip rail (220mm in length) complete with 9 1/2" drive socket clips
TPX bit sockets 1/2" drive	TPX20, TPX25, TPX27, TPX30, TPX40, TPX45, TPX50, TPX55, TPX60



M1213TX 1/2" Drive TX bit sockets

Set of 9 1/2" drive TX bit sockets for internal TX heads supplied on a clip rail. Satin finish.

Accessories	1 clip rail (220mm in length) complete with 9 1/2" drive socket clips
TX bit sockets 1/2" drive	TX20, TX25, TX27, TX30, TX40, TX45, TX50, TX55, TX60



3/4" Drive Socket Sets

T3418-6 3/4" drive Socket Set

18 piece 3/4" drive socket set containing 6 point sockets, 450mm T handle, 200 and 400mm extension bars as well as a 72 teeth ratchet with quick release and twist reverse. Supplied in a plastic carrying case with latch lid, retractable handle and metal pin hinges. The underside of the case is fitted with rubber feet to prevent it from sliding. (580x325x96mm, 14.2 kilos)

Accessories 3/4" drive	Quick release 72 teeth ratchet, 200 & 400mm extensions, sliding T-bar
Regular sockets 3/4" drive 6 point	19, 21, 22, 24, 27, 30, 32, 33,34, 36, 38, 41, 46, 50mm



T3422S 3/4" drive Socket Set

22 piece 3/4" drive socket set containing 8 metric 6 point sockets and 9 AF 12 point sockets, ratchet handle with 72 teeth and quick release button, 100, 200 and 400mm extension bars with security locking mechanism and a sliding T bar. Supplied in a plastic carrying case with latch lid, retractable handle and metal pin hinges. The underside of the case is fitted with rubber feet to prevent it from sliding. (580x325x96mm, 15.0 kilos)

Accessories 3/4" drive	Quick release 72 teeth ratchet, 100, 200 and 400mm extension bars, sliding T bar
Regular sockets 3/4" drive 6 point	19, 21, 24, 27, 32, 34, 36, 50mm
Regular sockets 3/4" drive 12 point	7/8" (22mm), 1" 1/8", 1 1/16" (30mm) 1 1/16" (33mm), 1 1/8" (38mm), 1 1/4" (41mm), 1 1/2" (46mm), 2"



TTX3404 3/4" ratchet & accessories

4 piece 3/4" drive set containing 72 teeth ratchet handle with quick release and twist reverse, two extension bars 200mm and 400mm as well as a sliding T bar. Supplied in the unique Teng Tools TTX tray for use on it's own or as part of the Teng Tools TC control system. (570x115x70mm, 6.1 kilos)



Accessories 3/4" drive Quick release ratchet handle, 200 and 400mm extensions, sliding T bar

TEX3403 3/4" Drive Ratchet and Accessories

3 piece 3/4" drive set containing a 72 teeth ratchet handle with quick release and twist reverse together with a 16" extension bar and sliding T bar, supplied in the unique Teng Tools drawer width TTX tray for use on it's own or as part of the Teng Tools TC control system. The tools are held in place using the Teng Tools three colour pre-cut EVA foam tool control system. (570x115x70mm, 5.3 kilos)

NEW!



Accessories 3/4" drive Quick release ratchet handle, 400mm, extension bar, sliding T bar

TTX3404S 3/4" drive ratchet and accessories with safety locking mechanism

4 piece 3/4" drive set containing 72 teeth ratchet handle with quick release and twist reverse, two extension bars 200mm and 400mm as well as a sliding T bar. The accessories incorporate a safety locking mechanism to avoid tools being dropped. Supplied in the unique Teng Tools drawer width TTX tray for use on it's own or as part of the Teng Tools TC control system. (570x115x70mm, 6.5 kilos)



Accessories 3/4" drive Quick release ratchet handle, 200 and 400mm extensions, sliding T bar

TTX3414 3/4" drive socket set

14 piece set containing 6 point metric sockets. Chrome vanadium steel. Supplied in the unique Teng Tools TTX tray for use on it's own or as part of the Teng Tools TC control system. (570x115x74mm, 5.5 kilos)



Regular sockets 3/4" drive 6 point 19, 21, 22, 24, 27, 30, 32, 33, 34, 36, 38, 41, 46, 50mm

TEX3410 3/4" Drive Socket Set

NEW!

10 piece set containing 6 point metric sockets. Chrome vanadium steel. Supplied in the unique Teng Tools drawer width TTX tray for use on it's own or as part of the Teng Tools TC control system. The tools are held in place using the Teng Tools three colour pre-cut EVA foam tool control system. (570x115x70mm, 4.6 kilos)



Regular sockets 3/4" drive 6 point 22, 24, 27, 30, 32, 36, 38, 41, 46, 50mm

TTX34AF 3/4" drive AF socket set

14 piece set containing 12 point AF sockets. Chrome vanadium steel. Supplied in the unique Teng Tools TTX tray for use on it's own or as part of the Teng Tools TC control system. (570x115x74mm, 5.5 kilos)



Regular sockets 3/4" drive 12 point 7/8" 15/16" 1" 1 1/8" 1 1/4" 1 1/2" 1 3/4" 1 7/8"

TTESK32 3/4" drive socket set

Set containing 3/4" drive regular metric and AF sockets together with a 72 teeth ratchet, extension bar, sliding T bar and flex handle - all with safety locking mechanism to hold sockets on tightly. Supplied in the Teng Tools three colour pre-cut EVA foam tool control system. (570x375x75mm, 17.27 kilos)



Accessories 3/4" drive 72 teeth ratchet, sliding T bar, 16" extension bar, 19" flex handle - all accessories with safety locking.
 Regular sockets 3/4" drive 6 point 19, 21, 22, 24, 27, 30, 32, 33, 34, 36, 38, 41, 46, 50mm
 Regular sockets 3/4" drive 12 point 7/8" 15/16" 1" 1 1/8" 1 1/4" 1 1/2" 1 3/4" 1 7/8"

1" Drive Socket Sets

M1115MM 1" Drive socket set

15 piece 1" drive metric 12 point socket set containing 560mm handle bar, 200 and 400mm extension bars as well as a ratchet head and T bar adaptor. Supplied in metal case with carrying handles. (680x210x110mm, 27.6 kilos)



Accessories 1" drive Flip reverse ratchet head with quick release, 22" handle bar, T bar adaptor, 200 and 400mm extension bars
 Regular sockets 1" drive 12 point 36, 41, 46, 50, 55, 60, 65, 70, 75, 80mm



Teng Tools - proud sponsors of speedway around the world.

RATCHETS

FRP ratchets

- Fibre ratchet handle with steel reinforcement that is lighter than standard ratchet handles, but just as strong.
- Ratchet mechanism with 45 teeth (8 degree interval).
- Quick release mechanism that makes it possible to release sockets and accessories with one hand.
- Lever for quick reversing between left and right-hand action.
- Design protected (24583ROC).
- Bi-material handle with an ergonomic design that makes the ratchet very comfortable to use, especially in cold environments.
- All individual parts and service kits are available and easy to fit.

72 teeth ratchets

- 72 teeth give a working arc of just 5 degrees, resulting in outstanding accessibility in confined areas.
- More teeth are engaged simultaneously – which means you can use greater force without the mechanism failing.
- The rotation disc, to change direction, has a good grip for oily fingers or gloves.
- The ratchet head is sealed, which prevents dirt and dust from entering the mechanism – giving a longer life and trouble-free use.
- Now available with a swivel ratchet head!

A selection of ratchet handles are available, including everything from a short 1/4" ratchet with T-handle to heavy duty ratchets with 1" drive. Several different types are available for 1/4", 3/8" and 1/2" drives. Teng Tools 72 teeth ratchets and the FRP ratchet all have buttons for the quick release of sockets and a lever or knob for reversing. You can choose the handle and head according to your taste and needs.

The 1" drive ratchets are manufactured fully in accordance with professional quality standards and have features such as removable heads and reversing lever. 3/4" and 1" ratchet wrenches with 72 teeth are also available and have a reversing disc and quick release for easier use.



1400B Mini Bits Ratchet

A 1/4" hex drive reversible ratchet with 8mm 12 point ring spanner. Drop forged. Chrome vanadium. Satin finish. Overall length 90mm



1400M Mini Palm Ratchet

Mini palm ratchet in 1/4" drive - ideal for use where space is very restricted. Reversible action. 45 teeth for 8 degree increments. Overall length 76mm, height 29mm, weight 90g.



72 Teeth Ratchets

The latest generation of industrial style 1/4", 3/8" and 1/2" drive ratchets from Teng Tools with 72 teeth to give a 5° increment between clicks for good access in confined spaces. A slim design together with a bi-material grip, quick release (on 3/8" and 1/2" drive versions) and twist reverse all combine to make a comfortable to use ratchet. An uncomplicated mechanism with several teeth engaging simultaneously for higher torque capacity, extended life and easier servicing. Ideal for use in confined spaces and where a smooth action is required.



72 Teeth Ratchets →

Stock No.	Drive	DIN	Description	Number of teeth	Length mm	Weight g
1400-72N	1/4"	3122D	ratchet	72	150	110
3800-72N	3/8"	3122D	ratchet with quick release	72	203	265
1200-72N	1/2"	3122D	ratchet with quick release	72	250	400

72 Teeth Flex Head Ratchets

Flexible head ratchets in 1/4" 3/8" and 1/2" drive from Teng Tools with 72 teeth to give a 5° increment between clicks. A slim design together with a bi-material grip, quick release and twist reverse on the 3/8" and 1/2" drive versions and twist reverse on the 1/4" drive model all combine to make a comfortable to use ratchet. An uncomplicated mechanism for extended life and easier servicing. Ideal for use in confined spaces and where a smooth action is required.



72 Teeth Flex Head Ratchets →

Stock No.	Drive	Description	Number of teeth	Length mm	Weight g
1400-72SN	1/4"	ratchet	72	121	114
3800-72SN	3/8"	ratchet with quick release	72	178	270
1200-72SN	1/2"	ratchet with quick release	72	190	395

FRP Ratchets

Teng Tools steel reinforced fibre ratchets have been designed to create a 45 teeth (8 degree increment) ratchet with quick release and flip reverse to meet or exceed all internationally recognised quality and torque specifications. The design protected ratchet (24583ROC) is not only lighter and just as strong but is also much more comfortable to use than regular ratchets. New style bi-material handles for a more comfortable grip.



FRP Ratchets →

Stock No	Drive	DIN	Description	Maximum recommended torque	Number of teeth	length mm	Weight g
1400FRP	1/4"	3122D	1/4" drive fibre reinforced ratchet handle with flip reverse and quick release	62Nm	45	150	96
3800FRP	3/8"	3122D	3/8" drive fibre reinforced ratchet handle with flip reverse and quick release	202Nm	45	203	227
1200FRP	1/2"	3122D	1/2" drive fibre reinforced ratchet handle with flip reverse and quick release	512Nm	45	255	358

Stainless Steel Ratchets

Stainless steel ratchet with 36 teeth with flip reverse and quick release button. Ideal for the food, medical, aerospace and marine industries or for use in any acidic environment.

Stock No.	Drive	No of teeth	Overall length mm	Weight g
MS3800	3/8"	36	204	424
MS1200	1/2"	36	266	900

Stainless Steel Ratchets →



72 Teeth Ratchets

The heavy duty 3/4" and 1" drive ratchets with 72 teeth are manufactured to full professional quality standards and feature twist reverse action. They also feature a quick release button for added convenience.



72 Teeth Ratchets →

Stock No	Drive	Description	Number of teeth	length mm	Weight g
M3400-72	3/4"	3/4" drive ratchet with twist reverse and quick release	72	505	2000
M1100-72	1"	1" drive ratchet with twist reverse and quick release	72	800	4060

Heavy Duty 1" Drive Ratchets

The heavy duty 1" drive ratchets are manufactured to full professional quality standards and feature removable heads and flip reverse action. Knurled handle.



Heavy Duty Ratchets →

Stock No	Drive	DIN	Description	Number of teeth	length mm	Weight g
M1100	1"	3122D	ratchet with detachable head	24	665	4410
M110010	1"	3122D	detachable ratchet head	24	165	1740
M110020	1"	-	22" power bar for use with M110010	-	560	2670

Long arm flexible ratchet

This 400mm long 1/2" drive flexible ratchet features twist reverse and quick release function and a 45 teeth ratchet. Two component non slip handle. Satin finish.



Long arm ratchet

400mm long 1/2" drive ratchet featuring twist reverse and quick release function and a 45 teeth ratchet. Two component non slip handle. Satin finish.



Service Kits for Ratchets

Stock No.	Suitable for	Drive
1400-72NRK	Service kit for 1400-72N	1/4"
1400-72NRK	Service kit for 1400-72SN	1/4"
1400FRPRK	Service Kit for 1400FRP	1/4"
3800-72NRK	Service kit for 3800-72N	3/8"
3800-72NRK	Service kit for 3800-72SN	3/8"
3800FRPRK	Service Kit for 3800FRP	3/8"
MS3800RK	Service kit for MS3800	3/8"
1200-72NRK	Service kit for 1200-72N	1/2"
1200-72NRK	Service Kit for 1200-72SN	1/2"
1200FRPRK	Service Kit for 1200FRP	1/2"
MS1200RK	Service kit for MS1200	1/2"
1201RK	Service Kit for 1201	1/2"
1201ARK	Service kit for 1201A	1/2"
1200FRK	Service Kit for 1200F and 1200L	1/2"
M3400-72RK	Service Kit for M3400-72	3/4"
M1100-72RK	Service Kit for M1100-72	1"
M1100RK	Service Kit for M1100	1"

All Teng Tools ratchets should be cleaned and maintained on a regular basis to reduce wear and to prolong life. However, with all tools involving moving parts some wear will occur with time.

Teng Tools offer a full range of complete service kits and spare parts for their ratchets - full details available from your local Teng Tools stockist.

- All Teng Tools sockets and accessories are individually marked and manufactured from high quality chrome vanadium steel to comply with the latest DIN and ISO standards.



- All sockets are produced according to Teng Tools "hip grip" system, which means the socket grips on the flat surfaces of the nut rather than on the corner. This system helps to prevent damage to nuts and bolts and makes it possible to grip nuts and bolts which already have damaged corners.
- The range includes standard extensions and swivel extensions in lengths from 50 mm to 500 mm.
- The safety lock system on the 3/4" extension bars prevents sockets from loosening unintentionally while working.
- All sockets and accessories are supplied on a hanging card, which for 1/4", 3/8" and 1/2" drives includes a socket clip for use on the Teng Tools aluminium clip rail. This allows users to put together their own individual clip rail sets designed to suit their own needs.
- Retaining grub screws are fitted to many accessories for extra safety when working in confined areas.
- 3 function adaptors that increase or decrease as well as including the possibility of a T-handle together with an extension bar.
- Screwdriver handle with square drive at the end of the handle to create a T handle that gives extra torque.



SOCKETS AND ACCESSORIES

The socket range includes drives between 1/4" and 1" and includes six-point sockets and twelve-point sockets, metric and imperial sizes as well as TX-E. A wide range of bit sockets for six-point, TX and TPX is supplemented further by a range of adaptors for use with the comprehensive range of bits, found in the screwdriver range.



Extension bars

Chrome vanadium steel. Satin finish.

Stock No.	Drive	Type	DIN	Description	Length mm	Weight g
M140020-C	1/4"	A	3123B	2" extension bar	50	22
M140023-C	1/4"	A	3123B	3" extension bar	75	35
M140021-C	1/4"	A	3123B	4" extension bar	100	46
M140022-C	1/4"	A	3123B	6" extension bar	150	65
M140038-C	1/4"	-	3123B	6" flexible extension bar with protective cover	150	26
M380020-C	3/8"	A	3123B	3" extension bar	75	75
M380023-C	3/8"	A	3123B	5" extension bar	125	120
M380021-C	3/8"	A	3123B	6" extension bar	150	145
M380022-C	3/8"	A	3123B	10" extension bar	254	242
M120020-C	1/2"	A	3123B	2 1/2" extension bar	63.5	105
M120021-C	1/2"	A	3123B	5" extension bar	125	222
M120023-C	1/2"	A	3123B	6" extension bar	150	240
M120022-C	1/2"	A	3123B	10" extension bar	255	420
M340020-C	3/4"	A	3123B	4" extension bar	100	400
M340020S-C	3/4"	A	3123B	4" extension bar with safety locking mechanism	100	450
M340021-C	3/4"	A	3123B	8" extension bar	200	700
M340021S-C	3/4"	A	3123B	8" extension bar with safety locking mechanism	200	750
M340022-C	3/4"	A	3123B	16" extension bar	400	1400
M340022S-C	3/4"	A	3123B	16" extension bar with safety locking mechanism	400	1400
M110040	1"	A	3123B	8" extension bar	200	1350
M110050	1"	A	3123B	16" extension bar	400	2400

TENG TOOLS SAFETY LOCKING MECHANISM

3/4" drive sockets can be heavy and if they drop from the ratchet or an extension bar or accessory it can be a health and safety risk. To reduce the likelihood of this happening Teng Tools have introduced a range of 3/4" drive extension bars, a sliding T bar and a universal joint with a safety locking mechanism. This is a simple design which effectively locks the socket in place to prevent it falling off under its own weight. The safety locking accessories are available individually or as part of a 22 piece socket set or an EVA tray set. One more example of how Teng Tools works to create user friendly tools.



TTXEXT13 Extension bar set

Set containing 6 extension bars (1/4", 3/8" and 1/2" drive), universal joints 1/4", 3/8" and 1/2", 3/8"-1/4" adaptor, as well as a T handle and mini screwdrivers for tightening the retaining grub screws in the adaptors. The unique T handle can be used in conjunction with the extension bars to create a comfortable T handle grip for added torque and ease of use. Supplied in the unique Teng Tools TC tray for use on it's own or as part of the Teng Tools TC control system. (570x115x40mm, 2.0 kilos)



Accessories	1/4" drive	3/8" drive	1/2" drive
	6" and 12" extensions, universal joint	3" wobble extension, 20" extension, universal joint, 3/8" F:1/4" M T bar adaptor	3" wobble extension, 20" extension, universal joint
	T handle grip, 2.0mm hex and 2.5mm hex mini screwdrivers		

TEXEXT13 Socket Accessories Set

13 piece extension and socket accessory set. Supplied in the unique Teng Tools drawer width TTX tray for use on it's own or as part of the Teng Tools TC control system. The tools are held in place using the Teng Tools three colour pre-cut EVA foam tool control system. (570x115x40mm, 2.20 kilos)



Accessories	1/4" drive	3/8" drive	1/2" drive
	6" and 12" extension bars, universal joint	3" wobble extension bar, 20" extension bar, universal joint, 3/8" F:1/4" M T bar adaptor	3" wobble extension bar, 20" extension bar, universal joint
	T handle grip, 2 and 2.5mm mini hex drivers		

TYPE B

Wobble Extension Bars

Chrome vanadium steel. Satin finish wobble bars that allow sockets to be turned at an angle, particularly useful in confined spaces.



Extension Bars →

Stock No.	Drive	Type	DIN	Description	Length mm	Weight g
M380020W-C	3/8"	B	-	3" wobble extension bar	75	63
M380021W-C	3/8"	B	-	6" wobble extension bar	150	145
M380022W-C	3/8"	B	-	10" wobble extension bar	255	234
M120020W-C	1/2"	B	-	3" wobble extension bar	75	105
M120021W-C	1/2"	B	-	6" wobble extension bar	150	240
M120022W-C	1/2"	B	-	10" wobble extension bar	255	420

Extension Bars

TYPE C



Stock No.	Drive	Type	DIN	Description	Length mm	Weight g
M140024-C	1/4"	C	3123B	12" extension bar	305	126
M380024-C	3/8"	C	3123B	20" extension bar	500	506
M120024-C	1/2"	C	3123B	20" extension bar	500	855

Universal Joints

Chrome vanadium steel. Satin finish.

Stock No.	Drive	DIN	Description	Length mm	Weight g
M140030-C	1/4"	3123C	1/4" drive universal joint	33	23
M380030-C	3/8"	3123C	3/8" drive universal joint	50	65
M120030-C	1/2"	3123C	1/2" drive universal joint	69	165
M340030-C	3/4"	3123C	3/4" drive universal joint	108	570



Universal Joints →

Adaptors

Chrome vanadium. Socket converters with T handle hole facility on most popular sizes. Satin finish.

Stock No.	DIN	Drive	Description	T drive facility	Length mm	Weight g
M140036-C	-	1/4"	1/4" female: 3/8" male adaptor	No	25.0	20
M140037	-	1/4"	1/4" male: 1/4" hex adaptor	No	25.0	7
M380035-C	3123A	3/8"	3/8" female: 1/4" male adaptor	Yes	25.4	20
M380036-C	3123A	3/8"	3/8" female: 1/2" male adaptor	Yes	36.0	45
M380037	-	3/8"	hex:3/8" male adaptor	No	32.0	14
M120036-C	3123A	1/2"	1/2" female: 3/8" male adaptor	Yes	39.5	55
M120037-C	3123A	1/2"	1/2" female: 3/4" male adaptor	No	39.5	55
M340085-C	-	3/4"	3/4" female: 1" male adaptor	No	62.0	370
M340086-C	3123A	3/4"	3/4" female: 1/2" male adaptor	Yes	40.0	52
M110030	-	1"	1" drive T bar adaptor	Yes	82.0	620



Adaptors →

Sockets and Accessories

TTADP17 Adaptor set

A set of 17 different adaptors for use with 1/4", 3/8", 1/2" and 3/4" drive sockets and accessories as well as 1/4" hex drive bits. Supplied in the unique Teng Tools TC tray with removable lid and dove tail joints for use on it's own or as part of the Teng Tools TC control system. (265x142x50mm, 1.3 kilos)

Step up adaptors	3/4"F:1"M, 1/2"F:3/4"M, 3/8"F:1/2"M, 1/4"F:3/8"M
Reducing adaptors	3/4"F:1/2"M, 1/2"F:3/8"M, 3/8"F:1/4"M
Coupler bit adaptors	1/4" and 3/8" drive for 1/4" hexagon bits
Hexagon bit adaptors	1/4" and 3/8" drive male adaptors
50mm hex bit adaptors	1/4", 3/8" and 1/2" drive male adaptors
Magnetic bit holders	50 and 70mm length
Chuck bit holders	50mm length with quick release



MX04 Insert Adaptor Set

Insert adaptors for converting up and with magnets in the drive disc. Available both as a set or individually covering 1/4" to 1" drive sizes. Ideal for where space is limited or a regular adaptor is not suitable.

A set of four insert adaptors	
Insert adaptors	1/4"F:3/8"M, 3/8"F:1/2"M, 1/2"F:3/4"M, 3/4"F:1"M



Insert Adaptors

Individual insert adaptors for converting up and with magnets in the drive disc. Ideal for where space is limited or a regular adaptor is not suitable. Also available as a set.

Insert Adaptors →

Stock No.	Drive Internal	Drive External	Dimensions Depth	Dimensions Width	Dimensions Height	Weight g
M140036M	1/4"	3/8"	28	28	15	18
M380036M	3/8"	1/2"	30	30	20	30
M120037M	1/2"	3/4"	45	45	30	86
M340085M	3/4"	1"	54	54	35	130

Coupler Adaptors

Coupler adaptors for Teng Tools bits.

Stock No.	Drive	DIN	Description	Length mm	Weight g
M140060-C	1/4"	3126	coupler adaptor for 1/4" hex bits	25	20
M380060-C	3/8"	3126	coupler adaptor for 1/4" hex bits	28	32
M380061-C	3/8"	3126	coupler adaptor for 10mm hex bits	28	32
M120060-C	1/2"	3126	coupler adaptor for 5/16" hex bits	38	88
M120061-C	1/2"	3126	coupler adaptor for 10mm hex bits	38	56
M120062-C	1/2"	3126	coupler adaptor for 12mm hex bits	38	62
M120063-C	1/2"	3126	coupler adaptor for 1/4" hex bits	25	88

Coupler Adaptors →



Sockets and Accessories

Sliding T Bars

Chrome vanadium steel. Satin finish.

Sliding T Bars →

Stock No.	Drive	DIN	Description	Length mm	Weight g
M140050-C	1/4"	3122A	1/4" drive sliding T Bar	106	40
M380050-C	3/8"	3122A	3/8" drive sliding T Bar	170	122
M120050-C	1/2"	3122A	1/2" drive sliding T Bar	243	300
M340050-C	3/4"	3122A	3/4" drive sliding T Bar	450	450
M340050S-C	3/4"	3122A	Sliding T Bar with safety locking mechanism	450	450



Speed Braces

Chrome vanadium steel. Satin finish. Plastic handle.

Speed Braces →

Stock No.	Drive	DIN	Description	Length mm	Weight g
M380011-C	3/8"	-	speed brace	380	310
M120011-C	1/2"	-	speed brace	420	585



Drivers

MD514N Flexible screwdriver handle with 1/4" square drive for bit sockets and standard sockets. Ergonomic TPR grip. Only for right hand action, i.e. clock wise turning (permitted load 5 Nm).
M140015-C and M380015-C with square drive for sockets and socket tools the handle part has internal square drive for connection, e.g. a T handle.
PT3810R with 3/8" square drive for sockets and socket tools. Two part plastic handle. Handle part has internal 3/8" square drive for connection to a ratchet handle or sliding T bar.

Drivers →

Stock No.	Drive	DIN	Description	Length mm	Weight g
MD514N	1/4"	-	flexi handle	275	100
M140015-C	1/4"	3122E	6" spinner handle	150	80
M380015-C	3/8"	3122E	10" spinner handle	255	280
PT3810R	3/8"	3122E	rotating spinner handle extension with power drive	253	302



MD514L Flexible 1/4" Drive Spinner Handle NEW!

A 555mm long flexible 1/4" drive spinner handle. The spring wound flexible shaft is protected by a plastic sleeve. The bi-material grip includes a T drive facility for added torque or for use as a hanging hole. The hole can also be used for securing the tool to a safety wire. Overall length 555mm, weight 213g).



TT1211 1/2" drive deep socket set

Set containing 10 12 point deep 1/2" drive sockets and 10" flex handle. Supplied in the unique Teng Tools TC tray with removable lid and dove tail joints for use on it's own or as part of the Teng Tools TC control system. (265x142x50mm, 2.0 kilos)



Accessories	1/2" drive	10" flex handle
Deep sockets	1/2" drive 12 point	10, 11, 12, 13, 14, 15, 16, 17, 18, 19mm



Flex Handles

Chrome vanadium steel. Satin finish.
Two component handle.

Flex Handles →

Stock No.	Drive	DIN	Description	Length mm	Weight g
M380010A-C	3/8"	-	Offset 10" flex handle	250	375
M120010-C	1/2"	3122F	10" flex handle	265	492
1201	1/2"	-	17" flex handle	450	894
1201A	1/2"	-	24" flex handle	600	1198
M340070-C	3/4"	3122F	19" flex handle	480	1880
M340070S-C	3/4"	3122F	19" flex handle with safety locking mechanism	480	1880
M110070	1"	-	25" flex handle	650	3550

Service Kits

Stock No.	Suitable for	Drive
1201RK	1201	1/2"
1201ARK	1201A	1/2"
M340070RK	M340070-C	3/4"
M340070SRK	M340070S-C	3/4"
M110070RK	M110070	1"

Spark Plug Sockets

6 point chrome vanadium sockets, with rubber insert.
Satin finish.

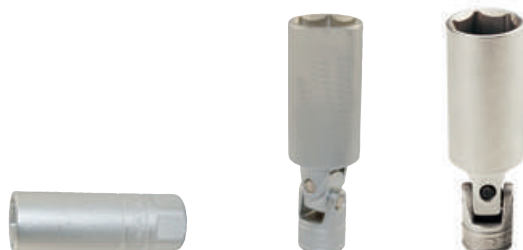

Spark Plug Sockets →

Stock No.	Drive	Description	Thread size	Length mm	Weight g
M380039-C	3/8"	6 point 14mm spark plug socket	8	64	73
M380040-C	3/8"	6 point 16mm spark plug socket	10	64	100
M380041-C	3/8"	6 point 16mm flexible spark plug socket	10	85	117
M380042-C	3/8"	6 point 18mm spark plug socket	12	70	130
M380046-C	3/8"	6 point 21mm spark plug socket	14	70	160
M380047-C	3/8"	6 point 21mm flexible spark plug socket	14	91	169
M120040-C	1/2"	6 point 16mm spark plug socket	10	70	165
M120042-C	1/2"	6 point 18mm spark plug socket	12	70	165
M120046-C	1/2"	6 point 21mm spark plug socket	14	70	165



All Teng Tools flex handles should be cleaned and maintained on a regular basis to reduce wear and to prolong life. However, with all tools involving moving parts some wear will occur with time.

Teng Tools offer a full range of complete service kits and spare parts for their ratchets – full details available from your local Teng Tools stockist.

DO'S AND DONT'S OF SOCKETRY

- ✔ **The right drive**
 Use the correct drive of ratchet or accessory to suit the size of fastening you need to turn and how much torque you need to apply. The larger the drive the more torque can be applied, particularly for stubborn or over tightened fastenings.
- ✔ **The right size socket**
 Use the correct size socket, the wrong size socket will damage the fastening making it more difficult to tighten or loosen. It might also damage the socket.
- ✔ **The weakest point**
 Remember that when trying to turn a stubborn nut or bolt it is the weakest point that will give first – chose the correct tool so that the weakest point is the rust, friction or adhesive that is holding the fastening in place.
- ✔ **Thread direction**
 Check that you are turning the correct way – on some engines and wheel assemblies the thread may be the opposite to normal
- ✔ **Keep it clean and dry**
 After use always check the tools are clean and dry before putting them away, this will help to avoid problems such as corrosion and moving parts seizing or becoming tight.
- ✔ **Maintenance**
 Regularly use a light oil to keep ratchet mechanisms in good working order and free from corrosion. Do not use heavy oils or greases as these tend to attract dirt which may cause the ratchet mechanism to slip.
- ✘ **Do not use chrome sockets with impact tools**
 Chrome sockets and accessories are designed to be used where pressure or torque is applied evenly, impact tools can damage regular sockets. Use impact sockets with impact tools.
- ✘ **Do not use TPX on TX type fastenings**
 Use the correct type as the shape is designed to fit tightly, if not the material is stressed and may fail
- ✘ **Do not use scaffolding poles or similar**
 If the fastening will not turn with the tools you are using you need to use a more powerful tool such as a larger drive ratchet, a flex handle or even an impact power tool. Do not use bars to increase the leverage – it is dangerous and can break the tool.
- ✘ **Do not use a vehicle to turn the socket**
 Do not fix the socket with a ratchet and then drive the vehicle to force the socket to turn – needless to say it is dangerous and can break the tools.



Accessories

Stock No.	Drive	DIN	Description	Length mm	Weight g
M120080-C	1/2"	-	1/2" drive flex head adaptor	70	188
T-HD	3/8"	-	for use with Type C extension bars to form a comfortable to use T handle	120	32

TTXTB05 3/8" Drive extra long swivel spark plug set

5 piece set with 3/8" drive extra long swivelling spark plug sockets and a T bar with handle. Supplied in the unique Teng Tools drawer width TTX tray for use on it's own or as part of the Teng Tools TC control system. (570x115x70mm, 6.5 kilos)

Spark plug sockets	14, 16, 21mm
Accessories	2 piece T bar handle



TEXTB05 T bar Spark Plug Socket Set NEW!

5 piece T bar spark plug socket set supplied in the unique Teng Tools drawer width TTX tray for use on it's own or as part of the Teng Tools TC control system. The tools are held in place using the Teng Tools three colour pre-cut EVA foam tool control system. (570x115x40mm, 1.4 kilos)



Accessories	T bar handle and T bar handle adaptor
520mm long T bar spark plug sockets	14, 16, 21mm

T bar universal joint spark plug sockets

520mm long with universal joint 6 point spark plug sockets, a T bar handle and 3/8" drive.

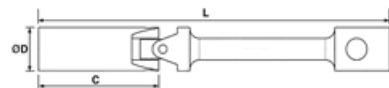

Stock No	Size mm	Thread mm	L mm	C mm	D mm	Weight g
TBUSP14	14	8	520	60	18.8	380
TBUSP16	16	10	520	60	21.8	400
TBUSP21	21	14	520	60	27.8	440
T-HD01	200mm x 8mm spare bar for use with T bar universal joint spark plug sockets					

1/4" Drive Sockets

1/4" Drive Metric Sockets

1/4" drive metric sockets, regular, 6 point, DIN 3120/3124/ISO 2725 Chrome vanadium. Satin Finish.

Stock no.	Size mm	L mm	T mm	D1 mm	D2 mm	Weight g
M140504-C	4	25.0	3.6	6.9	12.0	10
M1405045-C	4.5	25.0	3.6	7.5	12.0	12
M140505-C	5	25.0	4.2	8.1	12.0	12
M1405055-C	5.5	25.0	4.2	8.8	12.0	12
M140506-C	6	25.0	4.8	9.4	12.0	12
M140507-C	7	25.0	4.0	10.9	12.0	13
M140508-C	8	25.0	4.0	12.0	12.0	13
M140509-C	9	25.0	4.5	13.2	13.2	13
M140510-C	10	25.0	6.0	14.7	14.7	17
M140511-C	11	25.0	6.0	16.0	16.0	20
M140512-C	12	25.0	7.0	16.9	16.9	21
M140513-C	13	25.0	7.5	17.7	17.7	24

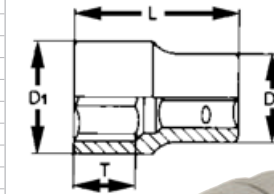

1/4" Drive Metric Sockets →

1/4" Drive AF Sockets

1/4" drive AF sockets, regular 6 point, DIN 3120/3124/ISO 2725 Chrome vanadium. Satin Finish.

Stock no.	Size	L mm	T mm	D1 mm	D2 mm	Weight g
M140106-C	3/16"	25.0	3.6	8.0	12.0	12
M140107-C	7/32"	25.0	4.2	8.8	12.0	12
M140108-C	1/4"	25.0	4.8	10.0	12.0	12
M140109-C	9/32"	25.0	4.0	10.9	12.0	13
M140110-C	5/16"	25.0	4.0	12.0	12.0	13
M140111-C	11/32"	25.0	4.5	13.2	13.2	18
M140112-C	3/8"	25.0	4.5	14.7	14.4	19
M140114-C	7/16"	25.0	6.0	16.0	16.0	22
M140116-C	1/2"	25.0	7.2	17.7	17.7	28

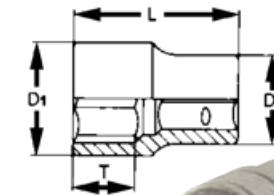

1/4" Drive AF Sockets →

1/4" Drive Deep Metric Sockets

1/4" drive metric sockets, deep 6 point, DIN 3120/3124/ISO 2725 Chrome vanadium, Satin Finish.

Stock no.	Size mm	L mm	T mm	D1 mm	D2 mm	Weight g
M140604-C	4	49.5	5.0	8.0	11.8	23
M140605-C	5	49.5	5.5	8.0	11.8	25
M1406055-C	5.5	49.5	5.5	8.8	11.8	26
M140606-C	6	49.5	6.5	9.4	11.8	26
M140607-C	7	49.5	10.5	10.9	11.8	27
M140608-C	8	49.5	10.5	11.8	11.8	30
M140609-C	9	49.5	11.5	12.8	12.8	37
M140610-C	10	49.5	13.0	14.5	14.5	38
M140611-C	11	49.5	14.0	15.6	15.6	43
M140612-C	12	49.5	15.0	16.6	16.6	46
M140613-C	13	49.5	17.0	17.6	17.6	48

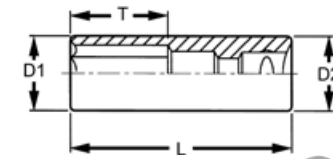

1/4" Drive Deep Metric Sockets →

Sockets and Accessories

1/4" Drive Deep AF Sockets

1/4" drive AF sockets, deep 6 point, DIN 3120/3124/ISO 2725 Chrome vanadium. Satin Finish.

Stock no.	Size	L	T	D1	D2	Weight
	mm	mm	mm	mm	mm	g
M140206-C	3/16"	49.5	5.0	8.0	11.8	24
M140207-C	7/32"	49.5	5.5	8.8	11.8	26
M140208-C	1/4"	49.5	6.5	10.0	11.8	27
M140209-C	9/32"	49.5	5.5	10.8	11.8	26
M140210-C	5/16"	49.5	10.5	11.8	11.8	30
M140211-C	11/32"	49.5	11.5	12.8	11.8	34
M140212-C	3/8"	49.5	12.5	14.5	14.5	37
M140214-C	7/16"	49.5	14.5	15.8	15.8	44
M140216-C	1/2"	49.5	16.5	17.6	17.6	48

1/4" Drive Deep AF Sockets →

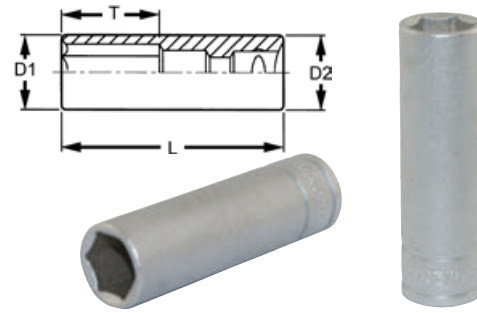

1/4" Drive TX-E Sockets

1/4" drive TX-E sockets. Chrome vanadium. Satin Finish.

Stock no.	Size	L	T	D1	D2	Weight
	mm	mm	mm	mm	mm	g
M140704-C	E4	3.83	23.1	3.5	5.8	12.0
M140705-C	E5	4.73	24.8	4.5	6.8	12.0
M140706-C	E6	5.74	24.8	4.5	8.0	12.0
M140707-C	E7	6.16	24.8	5.6	9.4	12.0
M140708-C	E8	7.52	24.8	6.0	10.4	12.0

1/4" Drive TX-E Sockets →

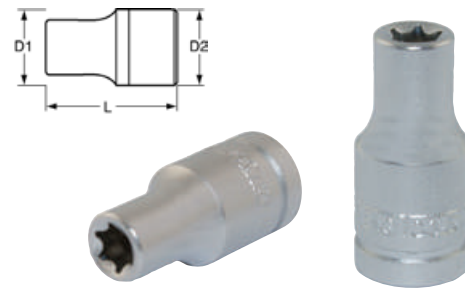

1/4" Drive PH Sockets

1/4" drive PH S2 socket bits DIN 5260 Chrome vanadium. Satin Finish.

Stock no.	Size	L1	L2	D	Weight
		mm	mm	mm	g
M141300-C	PH0	32.0	15.0	12.0	13
M141301-C	PH1	32.0	15.0	12.0	13
M141302-C	PH2	32.0	15.0	12.0	13
M141303-C	PH3	32.0	15.0	12.0	13

1/4" Drive PH Sockets →

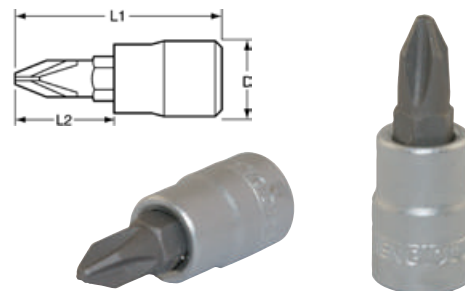

1/4" Drive Flat Sockets

1/4" drive flat S2 socket bits DIN 5264. Chrome vanadium.

Stock no.	Width	Thickness	L1	L2	D	Weight
	mm	mm	mm	mm	mm	g
M141404-C	4.0	0.76	32.0	15.0	12.0	13
M1414055-C	5.5	0.99	32.0	15.0	12.0	13
M141407-C	7.0	1.4	32.0	15.0	12.0	14

1/4" Drive Flat Sockets →

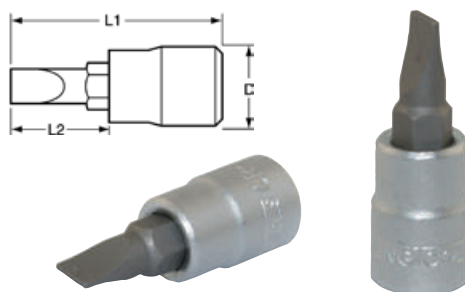

Sockets and Accessories

1/4" Drive PZ Sockets

1/4" drive PZ S2 socket bits. Chrome vanadium. Satin Finish.

Stock No.	Size	L1	L2	D	Weight
		mm	mm	mm	g
M141601-C	PZ1	32.0	15.0	12.0	13
M141602-C	PZ2	32.0	15.0	12.0	13
M141603-C	PZ3	32.0	15.0	12.0	13

1/4" Drive PZ Sockets →

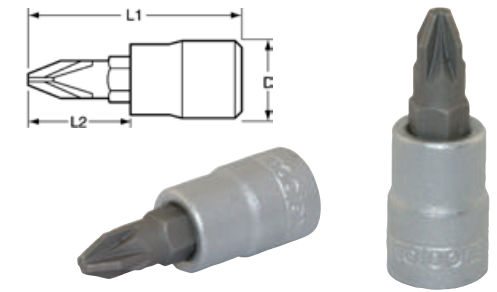

1/4" Drive TX Sockets

1/4" drive TX S2 socket bits. Chrome vanadium. Satin Finish.

Stock no.	Size	Size	L1	L2	D	Weight
		mm	mm	mm	mm	g
M141210T-C	TX10	2.5	32.0	15.0	12.0	13
M141215T-C	TX15	3.0	32.0	15.0	12.0	13
M141220T-C	TX20	3.5	32.0	15.0	12.0	13
M141225T-C	TX25	4.5	32.0	15.0	12.0	13
M141227T-C	TX27	5.0	32.0	15.0	12.0	14
M141230T-C	TX30	5.5	32.0	15.0	12.0	14
M141240T-C	TX40	6.5	32.0	15.0	12.0	14

1/4" Drive TX Sockets →

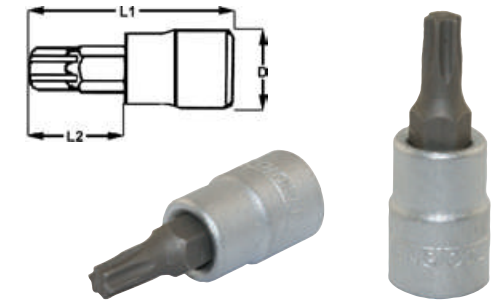

3/8" Drive Sockets

Stock no.	Size	L	T	D1	D2	Weight
	mm	mm	mm	mm	mm	g
M380507-C	7	25.7	4.0	10.8	17.1	21
M380508-C	8	25.7	4.5	12.0	17.1	25
M380509-C	9	25.7	5.0	13.1	17.1	26
M380510-C	10	25.7	5.0	14.7	17.1	26
M380511-C	11	25.7	7.0	16.0	17.1	26
M380512-C	12	25.7	7.0	17.1	17.1	29
M380513-C	13	25.7	7.0	18.3	18.3	32
M380514-C	14	25.7	9.0	19.5	19.5	40
M380515-C	15	25.7	10.0	20.4	20.4	43
M380516-C	16	29.0	10.0	22.1	22.1	43
M380517-C	17	29.0	10.0	23.3	23.3	50
M380518-C	18	29.0	15.5	24.2	20.0	56
M380519-C	19	29.0	15.5	25.7	21.0	64
M380520-C	20	29.0	15.5	26.7	22.0	71
M380521-C	21	29.0	15.5	27.7	23.0	78
M380522-C	22	29.0	15.5	29.8	24.0	82

3/8" Drive Metric Sockets →

3/8" Drive Metric Sockets

3/8" drive metric sockets regular 6 point, DIN 3120/3124/ISO 2725. Chrome vanadium. Satin Finish.

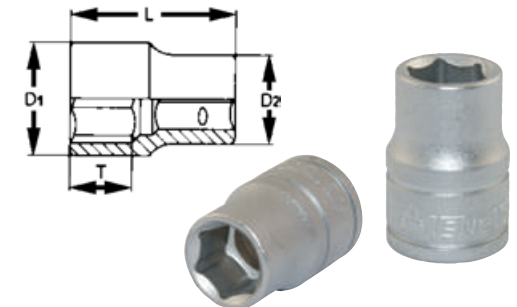

3/8" Drive AF Sockets

3/8" drive AF sockets regular 6 point, DIN 3120/3124/ISO 2725. Chrome vanadium. Satin Finish.

Stock no.	Size	L	T	D1	D2	Weight
		mm	mm	mm	mm	g
M380110-C	5/16"	25.7	4.5	11.7	17.1	23
M380112-C	3/8"	25.7	5.0	14.2	17.1	24
M380114-C	7/16"	25.7	7.0	16.3	17.1	26
M380116-C	1/2"	25.7	7.0	18.3	18.3	34
M380118-C	9/16"	25.7	9.0	19.5	19.5	38
M380120-C	5/8"	29.0	10.0	22.1	22.1	46
M380122-C	11/16"	29.0	10.0	24.2	20.0	50
M380124-C	3/4"	29.0	12.0	25.7	21.0	60
M380126-C	13/16"	29.0	13.0	27.7	23.0	68
M380128-C	7/8"	29.0	13.0	29.5	24.0	75

3/8" Drive AF Sockets →

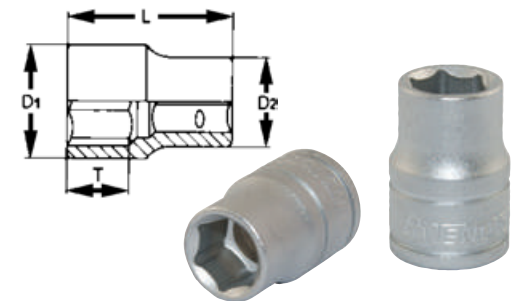

3/8" Drive Deep Metric Sockets

3/8" drive metric sockets deep 6 point, DIN 3120/3124/ISO 2725. Chrome vanadium. Satin Finish.

Stock no.	Size	L	T	D1	D2	Weight
	mm	mm	mm	mm	mm	g
M380607-C	7	45.5	10.0	10.8	16.5	40
M380608-C	8	45.5	12.0	12.0	16.5	50
M380609-C	9	45.5	14.0	13.1	16.5	55
M380610-C	10	45.5	15.0	14.7	16.5	60
M380611-C	11	45.5	17.0	16.5	16.5	70
M380612-C	12	45.5	18.0	17.1	17.1	75
M380613-C	13	45.5	18.0	18.5	18.5	85
M380614-C	14	50.0	18.0	19.5	19.5	95
M380615-C	15	53.0	20.0	20.4	20.4	100
M380616-C	16	53.0	20.0	22.0	22.0	105
M380617-C	17	56.0	20.0	23.3	23.3	120
M380618-C	18	56.0	20.0	24.2	24.2	125
M380619-C	19	56.0	20.0	25.7	25.7	130
M380620-C	20	63.5	22.0	26.8	26.8	140
M380621-C	21	63.5	22.0	27.7	27.7	165
M380622-C	22	63.5	22.0	29.5	29.5	165

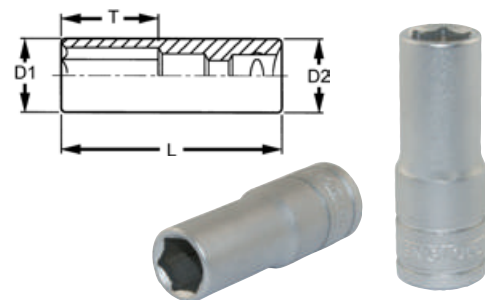

3/8" Drive Metric Deep Sockets →

3/8" Drive Deep AF Sockets

3/8" drive AF sockets deep 6 point, DIN 3120/3124/ISO 2725. Chrome vanadium, Satin Finish.

Stock no.	Size	L	T	D1	D2	Weight
	mm	mm	mm	mm	mm	g
M380212-C	3/8"	45.5	15.0	14.2	16.5	43
M380214-C	7/16"	45.5	17.0	16.5	16.5	50
M380216-C	1/2"	45.5	18.0	18.5	18.5	62
M380218-C	9/16"	50.0	18.0	19.5	19.5	72
M380220-C	5/8"	53.0	20.0	22.0	22.0	97
M380222-C	11/16"	56.0	20.0	24.2	24.2	125
M380224-C	3/4"	56.0	22.0	25.7	25.7	130
M380226-C	13/16"	63.5	22.0	27.7	27.7	140
M380228-C	7/8"	63.5	22.0	29.5	29.5	165

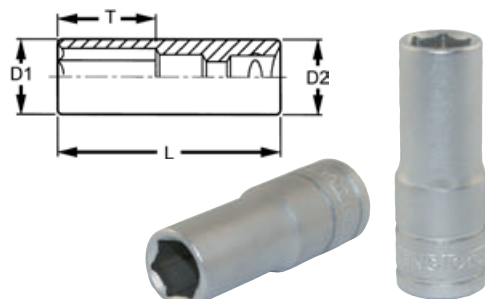

3/8" Drive Deep AF Sockets →

TTXTB09 3/8" Drive extra long socket set

9 piece set with 3/8" drive sockets and a T bar with handle. Supplied in the unique Teng Tools drawer width TTX tray for use on it's own or as part of the Teng Tools TC control system. (570x115x70mm, 6.5 kilos)

Extra long sockets	8, 10, 12, 13, 14, 17, 19mm
Accessories	2 piece T bar handle



TBW10 3/8" Drive T Bar Deep Metric Socket Set

A 10 piece set of deep sockets with a T bar handle and 3/8" drive. Supplied with a T bar and plastic T handle grip in a handy storage wallet. (2.33 kilos).

300mm long deep sockets	3/8" drive	7, 8, 10, 12, 13, 14, 17, 19mm
Accessories		2 piece T bar handle



S

3/8" Drive T bar deep sockets

300mm long deep sockets with a T bar handle and 3/8" drive.

Stock No.	Size	Drive	L	D	Weight
	mm		mm	mm	g
TBSKT07	7	3/8"	300	10	200
TBSKT08	8	3/8"	300	10	200
TBSKT10	10	3/8"	300	10	220
TBSKT12	12	3/8"	300	10	240
TBSKT13	13	3/8"	300	10	240
TBSKT14	14	3/8"	300	10	240
TBSKT17	17	3/8"	300	12	340
TBSKT19	19	3/8"	300	12	360

T-HD01 200mm x 8mm replacement bar for use with T Bar deep sockets
T-HD for use with T-HD01 to form a comfortable to use T handle

3/8" drive T bar deep sockets →

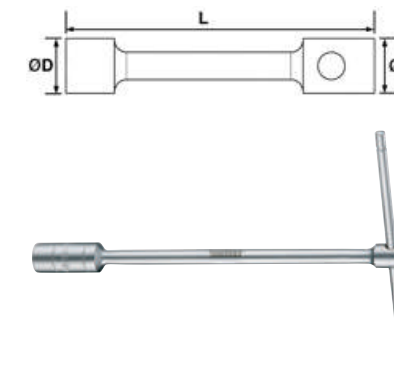

3/8" Drive TX-E Sockets

3/8" drive TX-E sockets, Chrome vanadium. Satin Finish.

Stock no.	Size	L	T	D1	D2	Weight
	mm	mm	mm	mm	mm	g
M380710-C	E10	9.42	28.0	7.2	13.0	25
M380712-C	E12	11.17	28.0	7.7	15.0	25
M380714-C	E14	12.90	28.0	9.6	16.3	30
M380716-C	E16	14.76	28.0	10.8	20.0	35
M380718-C	E18	16.70	28.0	12.0	22.0	40

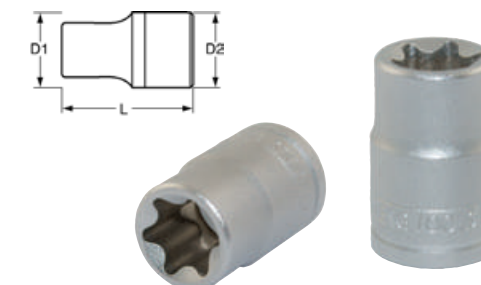

3/8" Drive TX-E Sockets →

3/8" Drive Metric Hex Bit Sockets

3/8" drive hex S2 socket bits. DIN 7422 Chrome vanadium. Satin Finish.

Stock no.	Size	L1	L2	D	Weight
	mm	mm	mm	mm	g
M381503-C	3	49.5	23.0	17.9	38
M381504-C	4	49.5	23.0	17.9	38
M381505-C	5	49.5	23.0	17.9	38
M3815055-C	5.5	49.5	23.0	17.9	38
M381506-C	6	49.5	23.0	17.9	38
M381507-C	7	49.5	23.0	17.9	40
M381508-C	8	49.5	23.0	17.9	44
M381510-C	10	49.5	23.0	17.9	52
M381512-C	12	49.5	23.0	22.0	56

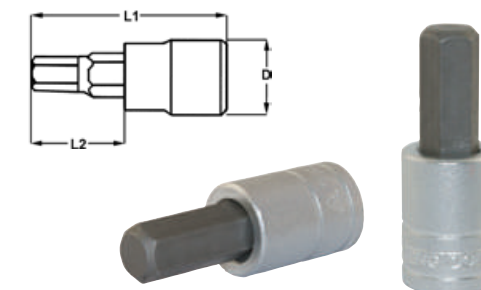

3/8" Drive Metric Hex Bit Sockets →

3/8" Drive AF Hex Bit Sockets

3/8" drive hex S2 socket bits. Chrome vanadium. Satin Finish.

Stock no.	Size	L1	L2	D	Weight
	AF	mm	mm	mm	g
M381103-C	3/32"	49.5	23.0	17.9	38
M381104-C	1/8"	49.5	23.0	17.9	38
M381105-C	5/32"	49.5	23.0	17.9	38
M381106-C	3/16"	49.5	23.0	17.9	38
M381107-C	7/32"	49.5	23.0	17.9	38
M381108-C	1/4"	49.5	23.0	17.9	38
M381110-C	5/16"	49.5	23.0	17.9	44
M381112-C	3/8"	49.5	23.0	17.9	44

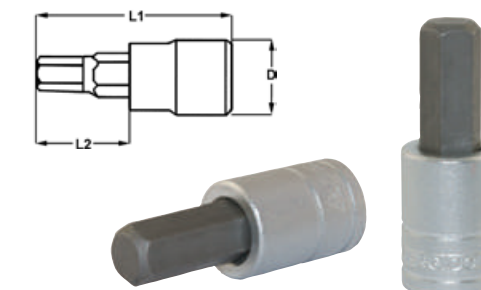

3/8" Drive AF Hex Bit Sockets →

3/8" Drive TPX Sockets

3/8" drive TPX socket bits. Chrome vanadium. Satin Finish.

Stock no.	Size	Size	L1	L2	D	Weight
			mm	mm	mm	g
M381210-C	TPX10	2.5	49.5	23.0	17.9	38
M381215-C	TPX15	3.0	49.5	23.0	17.9	38
M381220-C	TPX20	3.5	49.5	23.0	17.9	38
M381225-C	TPX25	4.5	49.5	23.0	17.9	38
M381227-C	TPX27	5.0	49.5	23.0	17.9	38
M381230-C	TPX30	5.5	49.5	23.0	17.9	38
M381240-C	TPX40	6.5	49.5	23.0	17.9	38
M381245-C	TPX45	7.5	49.5	23.0	17.9	38
M381250-C	TPX50	8.8	49.5	23.0	17.9	38

3/8" Drive TPX Sockets →

3/8" Drive TX Sockets

3/8" drive TX socket bits. Chrome vanadium. Satin Finish.

Stock no.	Size	Size	L1	L2	D	Weight
			mm	mm	mm	g
M381210T-C	TX10	2.5	49.5	23.0	17.9	38
M381215T-C	TX15	3.0	49.5	23.0	17.9	38
M381220T-C	TX20	3.5	49.5	23.0	17.9	38
M381225T-C	TX25	4.5	49.5	23.0	17.9	38
M381227T-C	TX27	5.0	49.5	23.0	17.9	38
M381230T-C	TX30	5.5	49.5	23.0	17.9	38
M381240T-C	TX40	6.5	49.5	23.0	17.9	38
M381245T-C	TX45	7.5	49.5	23.0	17.9	38
M381250T-C	TX50	8.8	49.5	23.0	17.9	38

3/8" Drive TX Sockets →

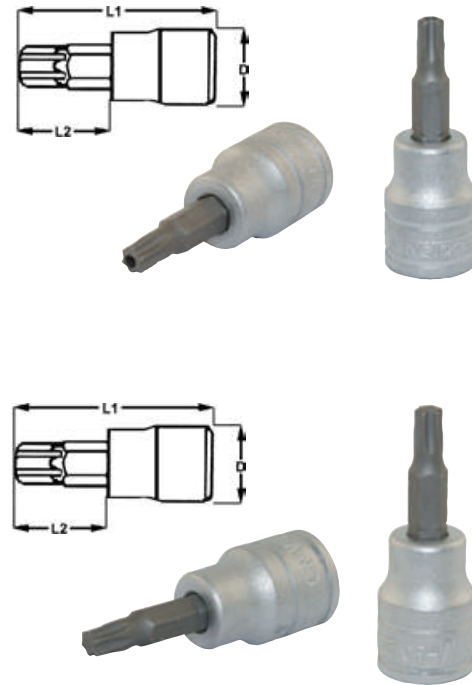

1/2" Drive Sockets

1/2" Drive Metric 12 Point Sockets

1/2" drive metric sockets regular 12 point, DIN 3120/3124/ISO 2725 Chrome vanadium. Satin Finish.

Stock no.	Size	L	T	D1	D2	Weight
		mm	mm	mm	mm	g
M120508-C	8	38.0	9.0	13.0	21.8	43
M120509-C	9	38.0	10.0	14.5	21.8	45
M120510-C	10	38.0	10.0	15.5	21.8	47
M120511-C	11	38.0	10.0	16.7	21.8	49
M120512-C	12	38.0	10.0	18.0	21.8	51
M120513-C	13	38.0	10.0	19.2	21.8	52
M120514-C	14	38.0	10.0	20.5	21.8	52
M120515-C	15	38.0	14.0	21.0	21.8	53
M120516-C	16	38.0	14.3	22.5	23.3	62
M120517-C	17	38.0	15.3	24.2	23.0	80
M120518-C	18	38.0	16.7	24.7	23.0	82
M120519-C	19	38.0	17.3	26.3	24.0	88
M120520-C	20	38.0	18.0	27.0	23.7	96
M120521-C	21	38.0	18.0	28.0	24.0	104
M120522-C	22	40.0	18.0	29.8	26.0	113
M120523-C	23	40.0	18.0	30.8	27.0	120
M120524-C	24	40.0	20.0	31.8	26.0	126
M120525-C	25	40.0	20.0	33.4	28.0	136
M120526-C	26	40.0	20.0	34.8	29.0	140
M120527-C	27	43.0	20.0	35.8	30.0	166
M120528-C	28	43.0	20.0	37.8	31.0	172
M120529-C	29	43.0	20.0	38.8	32.0	180
M120530-C	30	43.0	22.0	39.8	33.0	191
M120532-C	32	43.0	23.0	41.8	35.0	212
M120534-C	34	45.5	23.0	43.8	36.0	223

1/2" Drive Metric 12 Point Sockets →

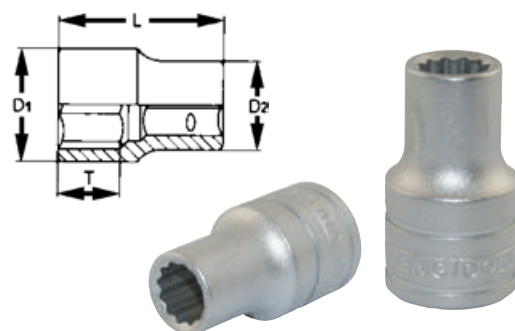

Stock no.	Size	L	T	D1	D2	Weight
		mm	mm	mm	mm	g
M1205106-C	10	38.0	10.0	15.5	21.8	47
M1205116-C	11	38.0	10.0	16.7	21.8	49
M1205126-C	12	38.0	10.0	18.0	21.8	51
M1205136-C	13	38.0	10.0	19.2	21.8	52
M1205146-C	14	38.0	10.0	20.5	21.8	52
M1205156-C	15	38.0	14.0	21.0	21.8	53
M1205166-C	16	38.0	14.3	22.5	23.3	62
M1205176-C	17	38.0	14.3	24.2	23.0	80
M1205186-C	18	38.0	15.3	24.7	23.0	82
M1205196-C	19	38.0	16.7	26.3	24.0	88
M1205206-C	20	38.0	17.3	27.0	24.0	96
M1205216-C	21	38.0	18.0	28.0	24.0	104
M1205226-C	22	40.0	18.0	29.8	26.0	113
M1205236-C	23	40.0	18.0	30.8	27.0	120
M1205246-C	24	40.0	18.0	31.8	26.0	126
M1205256-C	25	40.0	20.0	33.4	28.0	136
M1205266-C	26	40.0	20.0	34.8	29.0	140
M1205276-C	27	43.0	20.0	35.8	30.0	166
M1205286-C	28	43.0	20.0	37.8	31.0	172
M1205296-C	29	43.0	20.0	38.8	32.0	180
M1205306-C	30	43.0	22.0	39.8	33.0	191
M1205326-C	32	43.0	22.0	41.8	35.0	222
M1205336-C	33	45.5	23.5	42.8	35.0	235
M1205346-C	34	45.5	23.5	43.8	36.0	254

1/2" Drive Metric 6 point Sockets →

Stock no.	Size	L	T	D1	D2	Weight
		mm	mm	mm	mm	g
M120112-C	3/8"	38.0	9.0	14.7	21.8	46
M120114-C	7/16"	38.0	9.0	17.0	21.8	50
M120116-C	1/2"	38.0	10.0	19.0	21.8	52
M120118-C	9/16"	38.0	12.5	20.8	21.8	55
M120120-C	5/8"	38.0	14.3	23.3	22.5	62
M120122-C	11/16"	38.0	14.3	24.7	23.0	72
M120124-C	3/4"	38.0	20.0	26.3	24.0	76
M120126-C	13/16"	38.0	20.0	28.8	24.0	80
M120128-C	7/8"	40.0	21.0	29.8	26.0	95
M120130-C	15/16"	40.0	21.0	31.8	26.0	110
M120132-C	1"	43.0	21.0	33.4	27.3	120
M120134-C	1 1/8"	43.0	23.0	35.8	28.7	145
M120136-C	1 1/4"	43.0	23.0	37.8	31.0	150
M120138-C	1 3/8"	43.0	23.0	39.8	33.0	190
M120140-C	1 1/2"	43.0	23.0	41.8	34.0	205

1/2" Drive AF Sockets →

Stock no.	Size	L	T	D1	D2	Weight
		mm	mm	mm	mm	g
M120610-C	10	79.0	17.0	15.5	22.0	125
M120611-C	11	79.0	18.0	16.7	22.0	130
M120612-C	12	79.0	19.0	18.0	22.0	130
M120613-C	13	79.0	21.0	19.2	22.0	135
M120614-C	14	79.0	25.0	20.5	22.0	135
M120615-C	15	79.0	28.0	21.5	22.0	135
M120616-C	16	79.0	31.0	22.5	23.3	150
M120617-C	17	79.0	24.0	24.2	24.2	155
M120618-C	18	79.0	34.0	25.4	25.4	165
M120619-C	19	79.0	34.0	26.7	26.7	190
M120620-C	20	79.0	34.0	27.8	27.8	195
M120621-C	21	79.0	34.0	27.8	27.8	200
M120622-C	22	79.0	34.0	29.8	29.8	230
M120624-C	24	79.0	34.0	31.8	28.5	240
M120627-C	27	79.0	34.0	35.8	32.0	280
M120630-C	30	79.0	34.0	39.8	35.0	360
M120632-C	32	79.0	34.0	41.3	36.5	380
M120636-C	36	79.0	34.0	46.0	41.0	390

1/2" Drive Deep Metric 12 Point Sockets →

1/2" Drive Metric 6 Point Sockets

1/2" drive metric sockets regular 6 point, DIN 3120/3124/ISO 2725 Chrome vanadium. Satin Finish.

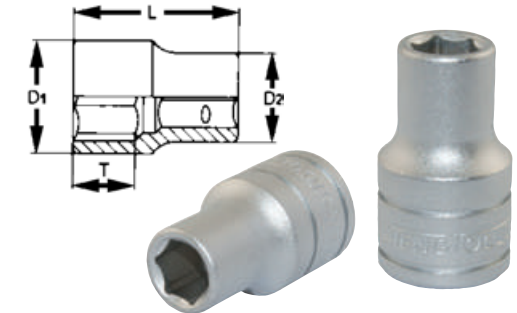

1/2" Drive AF Sockets

1/2" drive AF sockets regular 12 point, DIN 3120/3124/ISO 2725 Chrome vanadium. Satin Finish.

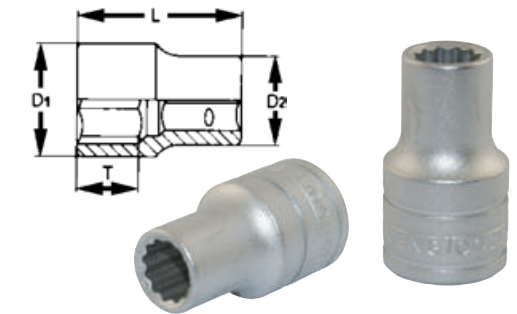

1/2" Drive Deep Metric 12 Point Sockets

1/2" drive metric sockets deep 12 point, DIN 3120/3124/ISO 2725. Chrome vanadium. Satin Finish.

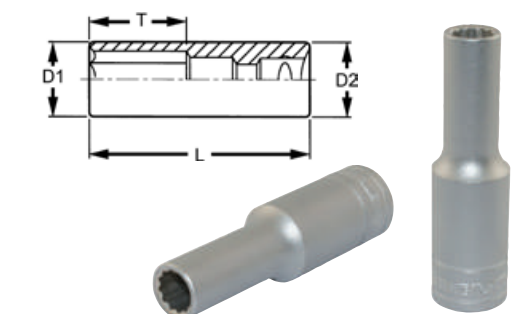

1/2" Drive Deep Metric 6 Point Sockets

1/2" drive metric sockets deep 6 point, DIN 3120/3124/ISO 2725 Chrome vanadium. Satin Finish.

Stock no.	Size	L	T	D1	D2	Weight
		mm	mm	mm	mm	g
M1206136-C	13	79.0	21.0	19.2	22.0	135
M1206146-C	14	79.0	25.0	20.5	22.0	135
M1206156-C	15	79.0	28.0	21.5	22.0	135
M1206166-C	16	79.0	31.0	22.5	23.3	150
M1206176-C	17	79.0	34.0	24.2	24.2	155
M1206186-C	18	79.0	34.0	25.4	25.4	165
M1206196-C	19	79.0	34.0	26.7	26.7	190
M1206246-C	24	79.0	34.0	31.8	31.8	240

1/2" Drive Deep Metric 6 Point Sockets →

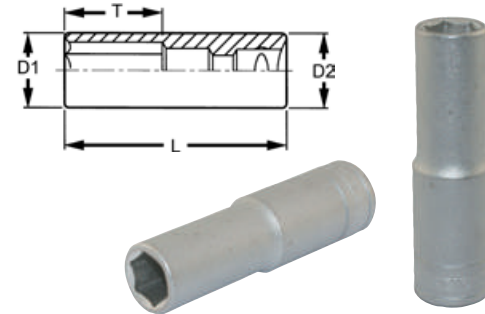

1/2" Drive Metric Hex Bit Sockets

1/2" drive hex S2 socket bits DIN 7422 Chrome vanadium. Satin Finish.

Stock no.	Size	L1	L2	D	Weight
		mm	mm	mm	g
M121505-C	5	55.0	20.5	22.0	52
M121506-C	6	55.0	20.5	22.0	54
M121507-C	7	55.0	20.5	22.0	60
M121508-C	8	55.0	20.5	22.0	62
M121509-C	9	55.0	20.5	22.0	66
M121510-C	10	55.0	20.5	22.0	72
M121512-C	12	55.0	20.5	22.0	80
M121514-C	14	55.0	20.5	22.0	96
M121517-C	17	55.0	20.5	25.0	154
M121519-C	19	60.0	23.0	25.9	182

1/2" Drive Metric Hex Bit Sockets →

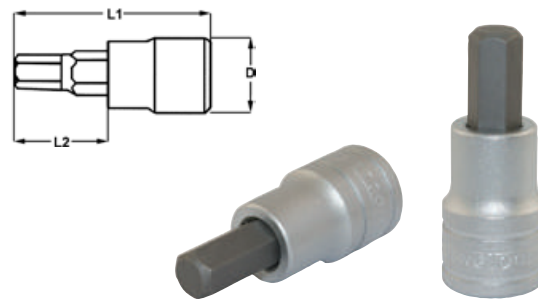

1/2" Drive Long Hex Sockets

1/2" drive long hex S2 socket bits DIN 7422 Chrome vanadium. Satin Finish.

Stock no.	Size	L1	L2	D	Weight
		mm	mm	mm	g
M122505-C	5	100.0	65.5	22.0	60
M122506-C	6	100.0	65.5	22.0	60
M122507-C	7	100.0	65.5	22.0	80
M122508-C	8	100.0	65.5	22.0	80
M122510-C	10	100.0	65.5	22.0	100
M122512-C	12	100.0	65.5	22.0	120
M122514-C	14	100.0	65.5	22.0	153
M122517-C	17	100.0	65.5	25.0	225

1/2" Drive Long Hex Sockets →

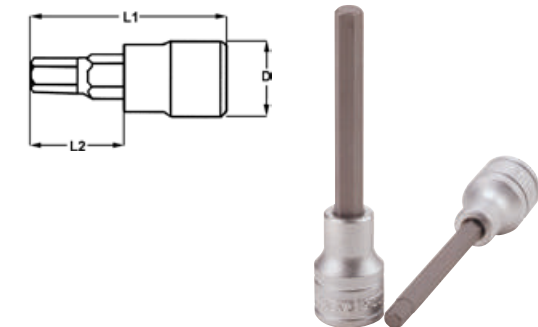

1/2" Drive Extra Long Hex Sockets

1/2" drive extra long S2 socket bits, DIN7422. Chrome Vanadium. Satin Finish.

Stock no.	Size	L1	L2	D	Weight
		mm	mm	mm	g
M122506A-C	6	115	80	22	100
M122508A-C	8	115	80	22	120
M122510L-C	10	175	140	22	150

1/2" Drive Extra Long Hex Sockets →

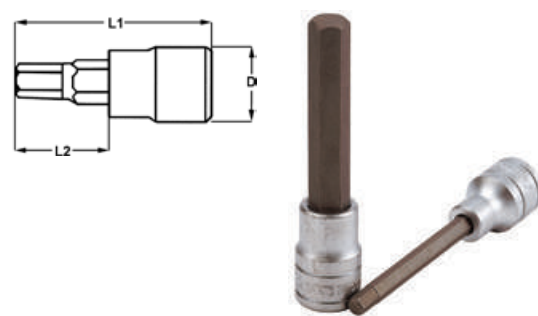

1/2" Drive AF Hex Bit Sockets

1/2" drive hex S2 socket bits DIN 7422 Chrome vanadium. Satin Finish.

Stock no.	Size	L1	L2	D	Weight
		mm	mm	mm	g
M121106-C	3/16"	55.0	20.0	22.0	55
M121107-C	7/32"	55.0	20.0	22.0	55
M121108-C	1/4"	55.0	20.0	22.0	55
M121109-C	9/32"	55.0	20.0	22.0	60
M121110-C	5/16"	55.0	20.0	22.0	62
M121112-C	3/8"	55.0	20.0	22.0	67
M121116-C	1/2"	55.0	20.0	22.0	85
M121118-C	9/16"	55.0	20.0	22.0	100
M121120-C	5/8"	55.0	20.0	22.0	120

1/2" Drive AF Hex Bit Sockets →

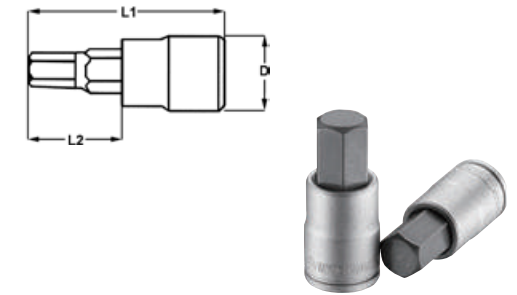

1/2" Drive XZN Socket Bits

1/2" drive 100mm long XZN socket bits. Chrome vanadium. Satin Finish.

Stock no.	Size	L1	L2	D	Weight
		mm	mm	mm	g
M122805-C	05	100	65.0	22.0	70
M122806-C	06	100	65.0	22.0	70
M122808-C	08	100	65.0	22.0	70
M122809-C	09	100	65.0	22.0	70
M122810-C	10	100	65.0	22.0	90
M122812-C	12	100	65.0	22.0	110
M122814-C	14	100	65.0	22.0	130
M122816-C	16	100	65.0	22.0	160

1/2" Drive Spline Socket Bits →

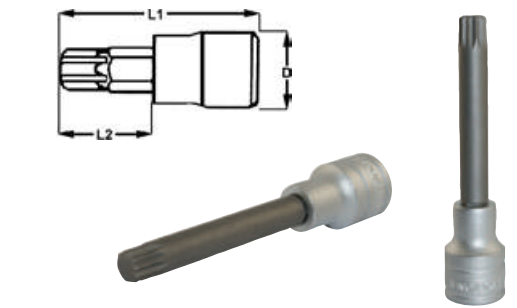

1/2" Drive Long Ribe Socket Bits

1/2" drive long Ribe socket bits. Chrome vanadium. Satin Finish.

Stock no.	Size	L1	L2	D	Weight
		mm	mm	mm	g
M122704-C	04	100	65.0	22.0	70
M122705-C	05	100	65.0	22.0	70
M122706-C	06	100	65.0	22.0	70
M122708-C	08	100	65.0	22.0	70
M122709-C	09	100	65.0	22.0	70
M122710-C	10	100	65.0	22.0	90
M122711-C	11	100	65.0	22.0	100
M122712-C	12	100	65.0	22.0	110
M122713-C	13	100	65.0	22.0	120

1/2" Drive Long Ribe Socket Bits →

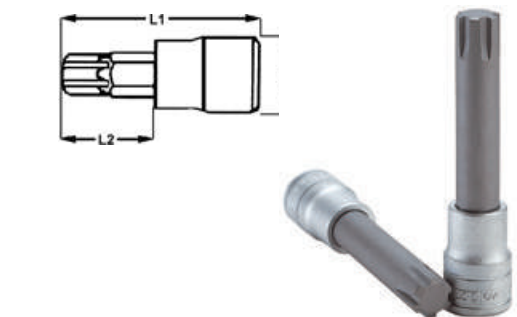

1/2" Drive TPX Socket Bits

1/2" drive TPX socket bits. Chrome vanadium. Satin finish.

Stock	Size	Size	L1	L2	D	Weight
		mm	mm	mm	mm	g
M121220-C	TPX20	3.5	55.0	20.5	22.0	60
M121225-C	TPX25	4.5	55.0	20.5	22.0	60
M121227-C	TPX27	5.0	55.0	20.5	22.0	60
M121230-C	TPX30	5.5	55.0	20.5	22.0	60
M121240-C	TPX40	6.5	55.0	20.5	22.0	68
M121245-C	TPX45	7.5	55.0	20.5	22.0	68
M121250-C	TPX50	8.8	55.0	20.5	22.0	68
M121255-C	TPX55	11.1	55.0	20.5	22.0	68
M121260-C	TPX60	13.1	55.0	20.5	22.0	68

1/2" Drive TPX Socket Bits →

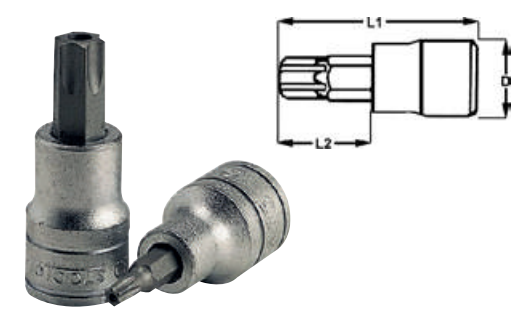

1/2" Drive TX Socket Bits

1/2" drive TX socket bits. Chrome vanadium. Satin Finish.

Stock no.	Size	Size mm	L1 mm	L2 mm	D	Weight g
M121220T-C	TX20	3.5	55.0	20.5	22.0	60
M121225T-C	TX25	4.5	55.0	20.5	22.0	60
M121227T-C	TX27	5.0	55.0	20.5	22.0	60
M121230T-C	TX30	5.5	55.0	20.5	22.0	60
M121240T-C	TX40	6.5	55.0	20.5	22.0	60
M121245T-C	TX45	7.5	55.0	20.5	22.0	68
M121250T-C	TX50	8.8	55.0	20.5	22.0	68
M121255T-C	TX55	11.1	55.0	20.5	22.0	68
M121260T-C	TX60	13.1	55.0	20.5	22.0	68

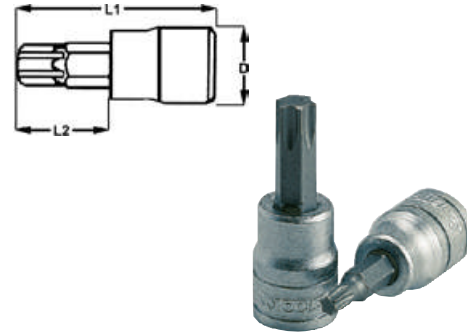

1/2" Drive TX Socket Bits →

1/2" Drive Long TX Socket Bits

1/2" drive 100mm long TX S2 socket bits. Chrome vanadium. Satin Finish.

Stock no.	Size	Size mm	L1 mm	L2 mm	D	Weight g
M122220T-C	TX20	3.5	100.0	65.5	22.0	60
M122225T-C	TX25	4.5	100.0	65.5	22.0	60
M122227T-C	TX27	5.0	100.0	65.5	22.0	60
M122230T-C	TX30	5.5	100.0	65.5	22.0	60
M122240T-C	TX40	6.5	100.0	65.5	22.0	60
M122245T-C	TX45	7.5	100.0	65.5	22.0	80
M122250T-C	TX50	8.8	100.0	65.5	22.0	100
M122255T-C	TX55	11.1	100.0	65.5	22.0	100
M122260T-C	TX60	13.1	100.0	65.5	22.0	100
M122270T-C	TX70	15.5	100.0	65.5	22.0	100

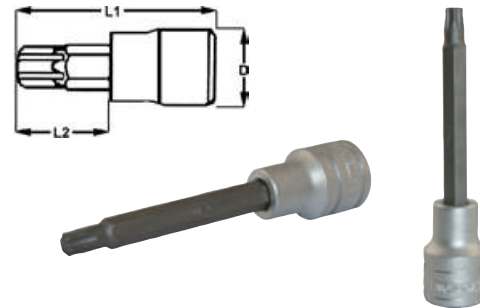

1/2" Drive Long TX Socket Bits →

1/2" Drive TX-E Sockets

1/2" drive TX-E sockets. Chrome vanadium. Satin Finish.

Stock no.	Size	Size mm	L	T	D1	D2	Weight g
M120710-C	E10	9.42	37.8	9.5	13.1	23.5	39
M120711-C	E11	10.08	37.8	9.5	14.1	23.5	42
M120712-C	E12	11.17	37.8	9.5	14.9	23.5	43
M120714-C	E14	12.90	37.8	12.3	16.7	23.5	44
M120716-C	E16	14.76	37.8	13.0	19.1	23.5	49
M120718-C	E18	16.70	37.8	13.0	20.9	23.5	52
M120720-C	E20	18.45	37.8	13.0	23.7	23.5	60
M120722-C	E22	20.30	37.8	16.1	26.1	26.1	82
M120724-C	E24	22.16	37.8	16.4	28.0	28.0	102

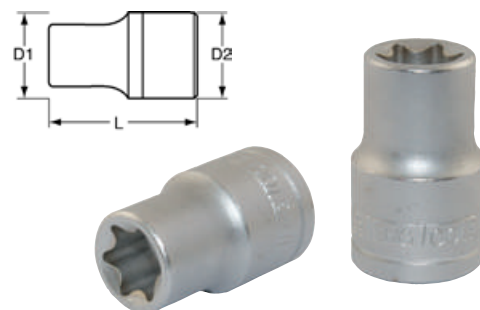

1/2" Drive TX-E Sockets →

3/4" Drive Sockets

3/4" Drive Metric 6 Point Sockets

3/4" drive sockets regular 6 point metric. Chrome vanadium. Satin Finish. DIN3120/3124.

Stock no.	Size	L mm	T mm	D1 mm	D2 mm	Weight g
M3405196-C	19	50.0	14	29.2	33	180
M3405216-C	21	50.0	14	31.2	33	180
M3405226-C	22	50.0	14	32.2	36	220
M3405246-C	24	51.0	16	34.2	36	230
M3405266-C	26	52.0	18	36.0	36	240
M3405276-C	27	52.0	22	38.0	36	240
M3405306-C	30	54.0	24	42.0	38	260
M3405326-C	32	56.0	26	44.0	38	310
M3405336-C	33	56.0	26	46.0	38	330
M3405346-C	34	56.0	26	47.0	38	350
M3405366-C	36	58.0	28	50.0	38	430
M3405386-C	38	60.0	28	52.0	42	500
M3405416-C	41	64.0	30	56.0	45	570
M3405466-C	46	68.0	34	62.0	45	690
M3405506-C	50	72.0	36	68.0	48	830

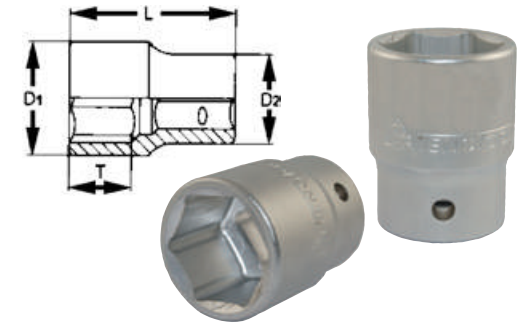

3/4" Drive Metric 6 Point Sockets →

3/4" Drive AF 12 Point Sockets

3/4" drive sockets regular 12 point, AF. Chrome vanadium. Satin Finish. DIN3120/3124.

Stock no.	Size	L mm	T mm	D1 mm	D2 mm	Weight g
M340124-C	3/4"	50.0	14.0	29.2	33.0	180
M340128-C	7/8"	51.0	18.1	32.2	36.2	195
M340130-C	15/16"	51.0	18.1	34.5	36.2	200
M340132-C	1"	51.0	24.0	37.0	37.0	200
M340134-C	1 1/16"	51.0	24.0	38.3	37.0	200
M340136-C	1 1/8"	51.0	24.3	40.0	38.5	230
M340138-C	1 3/16"	53.0	25.2	42.0	38.5	255
M340140-C	1 1/4"	55.0	28.0	44.0	38.5	275
M340142-C	1 1/2"	55.0	28.0	46.0	38.5	300
M340144-C	1 5/8"	57.0	29.7	48.0	42.3	360
M340146-C	1 3/4"	57.0	29.7	50.0	42.3	380
M340148-C	1 7/8"	60.0	31.1	52.1	45.2	440
M340152-C	1 15/16"	63.0	33.7	56.1	45.2	515
M340156-C	1 1/2"	65.0	33.7	60.0	48.0	610
M340158-C	1 5/8"	67.0	35.7	62.0	48.0	635
M340160-C	1 3/4"	69.0	37.2	64.0	48.3	690
M340164-C	2"	71.0	38.6	68.2	48.3	755

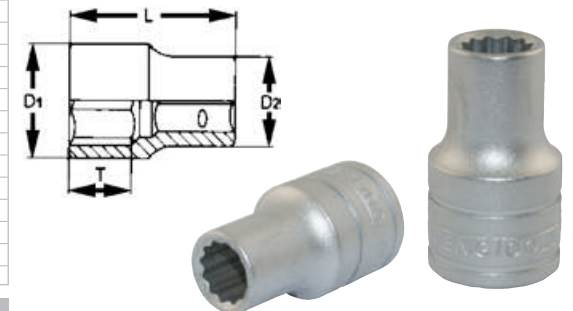

3/4" Drive AF 12 Point Sockets →

3/4" Drive Metric Hex Bit Sockets

3/4" drive hex socket bits. Satin Finish.

Stock no.	Size	L mm	T mm	D	Weight g
M341514-C	14	78.5	25	36	326
M341517-C	17	78.5	25	36	330
M341519-C	19	78.5	25	36	334
M341522-C	22	78.5	25	36	338

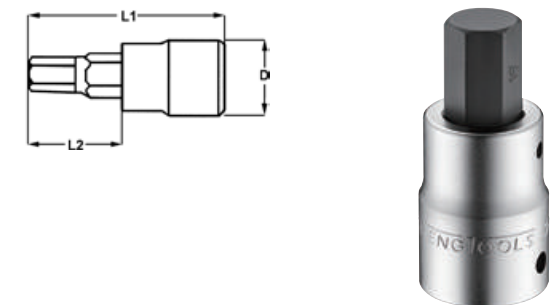

3/4" Drive Metric Hex Bit Sockets →

1" Drive Sockets

1" Drive Metric 12 Point Sockets

1" drive sockets regular 12 point metric. Chrome vanadium.

Stock no.	Size	L mm	T mm	D1 mm	D2 mm	Weight g
M110536	36	65.3	31.2	51.0	45.2	440
M110541	41	70.2	33.8	57.1	45.2	550
M110546	46	74.5	37.5	64.6	49.4	810
M110550	50	75.3	38.1	69.9	55.2	995
M110555	55	80.0	40.0	76.2	57.3	1160
M110558	58	80.0	40.0	79.2	57.3	1250
M110560	60	84.0	41.0	82.1	57.3	1410
M110565	65	87.3	46.2	88.0	57.3	1540
M110570	70	93.4	51.5	94.0	68.1	2020
M110575	75	96.1	51.5	94.0	68.1	2020
M110580	80	103.6	55.3	105.0	68.1	2500

1" Drive Metric 12 Point Sockets →

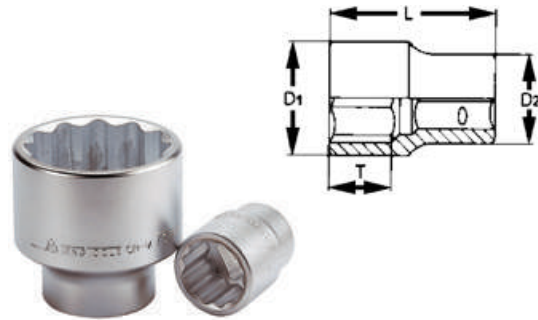

Stainless Steel Sockets

TS3816 Stainless Steel Socket Set

16 piece 3/8" drive stainless steel socket set containing 6 point regular sockets, ratchet, 3" and 6" extension bars 3/8" F- 1/2" M adaptor. Supplied in a plastic case with latch lock, retractable handle and metal pin hinges. The underside of the case is fitted with rubber feet to prevent it from sliding.

Ideal for the food, medical, aerospace and marine industries or for use in any acidic environment. The regular 6 point metric sockets are DIN 3120/3124/ISO 2725. 4430 **STAINLESS STEEL** Satin finish and laser marked. (369x198x62mm, 1.82 kilos)

Accessories	3/8" drive	Stainless steel ratchet, 3" and 5" extension, bar, 3/8" Fx1/2" M T bar adaptor
Regular sockets	3/8" drive	6 point 8, 9, 10, 11, 12, 13, 14, 15, 16, 17, 18, 19mm



TS1218 Stainless Steel Socket Set

18 piece stainless steel socket set, containing 12 regular metric sockets, 3 deep metric sockets, ratchet with 36 teeth, 5" extension, adaptor 1/2" F x 3/8" M. Supplied in a plastic carrying case with latch lid, retractable handle and metal pin hinges. The underside of the case is fitted with rubber feet to prevent it from sliding.

Ideal for the food, medical, aerospace and marine industries or for use in any acidic environment. The regular 6 point metric sockets are DIN 3120/3124/ISO 2725. 4430 **STAINLESS STEEL** Satin finish and laser marked. (369x198x62mm, 3.28 kilos)

Accessories	1/2" drive	Stainless steel ratchet, 5" extension, bar, 1/2" Fx3/8" M T bar adaptor
Regular sockets	1/2" drive	6 point 10, 11, 12, 13, 14, 15, 16, 17, 18, 19, 21, 22, 23, 24mm
Deep sockets	1/2" drive	6 point 17, 19, 21mm



MS3814 3/8" Drive Stainless steel sockets

14 piece 3/8" drive stainless steel sockets and extension bars supplied on a clip rail.

Accessories	1 clip rail complete with 14 3/8" drive socket clips	
	3/8" drive	3" and 5" extension bars
Regular sockets	3/8" drive	8, 9, 10, 11, 12, 13, 14, 15, 16, 17, 18, 19mm



MS1203 1/2" drive Stainless steel deep wheel nut sockets

3 piece 1/2" drive stainless steel 6 point sockets for most common wheel nut sizes. Suitable for use with impact guns.

Accessories	1 clip rail complete with 3 1/2" drive socket clips	
Deep sockets	1/2" drive	17, 19, 21mm



MS1213 1/2" drive stainless steel sockets

13 piece 1/2" drive stainless steel 6 point sockets and extension bar supplied on a clip rail.

Accessories	1 clip rail complete with 13 1/2" drive socket clips	
	1/2" drive	5" extension bar
Regular sockets	1/2" drive	10, 11, 12, 13, 14, 15, 16, 17, 18, 19, 21, 24mm



From the smallest to the largest Teng Tools has the tools you need.

Stainless Steel Ratchets

Stainless steel ratchet with 36 teeth with flip reverse and quick release button. Ideal for the food, medical, aerospace and marine industries or for use in any acidic environment.

Stock No.	Drive	No of teeth	Overall length mm	Weight g
MS3800	3/8"	36	204	424
MS1200	1/2"	36	266	900

Stainless Steel Ratchets →

Service Kits for Ratchets

All the replacement parts required to service the ratchet mechanism

Stock No.	Description	Drive
MS3800RK	Service kit for MS3800	3/8"
MS1200RK	Service kit for MS1200	1/2"

Stainless Steel Extension Bars

Stainless steel extension bars for use with the Teng Tools stainless sockets and ratchets

Stock No.	Drive	Type	Description	Length mm	Weight g
MS380020-C	3/8"	A	3" stainless steel extension bar	75	72
MS380023-C	3/8"	A	5" stainless steel extension bar	125	118
MS120021-C	1/2"	A	5" stainless steel extension bar	125	222

Stainless Steel Extension Bars →

Stainless Steel Socket Adaptors

Stainless steel T bar adaptors and drive adaptors for use with the Teng Tools stainless sockets and ratchets

Stock No.	Drive	Description	T Drive Facility	Length mm	Weight g
MS380036-C	3/8"	3/8"F:1/2"M T bar adaptor	Yes	36.0	45
MS120036-C	1/2"	1/2"F:3/8"M T bar adaptor	Yes	39.5	55

Stainless Steel Ratchets →



3/8" Drive Stainless Steel Sockets

3/8" drive metric stainless steel sockets, 6 point. Produced in accordance with DIN3120/3124/ISO2725. Satin finish and laser marked for brand and size. Ideal for the food, medical, aerospace and marine industries or for use in any acidic environment.

Stock No.	Size mm	D2 mm	L mm	D1 mm	T mm	Weight g
MS380508-C	8	16.8	26.0	12.1	6.0	22
MS380509-C	9	16.8	26.0	13.0	6.0	22
MS380510-C	10	16.8	26.0	14.6	6.0	23
MS380511-C	11	16.8	26.0	16.0	7.0	25
MS380512-C	12	16.5	26.0	16.8	7.4	24
MS380513-C	13	17.5	26.0	18.0	7.4	28
MS380514-C	14	17.8	26.0	19.2	10.5	29
MS380515-C	15	18.0	26.0	20.5	11.5	30
MS380516-C	16	18.5	29.0	21.8	13.0	41
MS380517-C	17	19.0	29.0	23.0	13.0	44
MS380518-C	18	20.0	29.0	24.2	13.0	47
MS380519-C	19	21.0	29.0	25.4	13.5	54

3/8" Drive Stainless Steel Sockets →

1/2" Drive Stainless Steel Sockets

1/2" drive stainless steel metric sockets regular, 6 point. Produced in accordance with DIN3120/3124/ISO2725. Satin finish and laser marked for brand and size. Ideal for the food, medical, aerospace and marine industries or for use in any acidic environment.

Stock No.	Size mm	D1 mm	D2 mm	L mm	T mm	Weight g
MS1205106-C	10	15.5	21.5	38.5	10.0	50
MS1205116-C	11	16.7	21.5	38.5	10.0	51
MS1205126-C	12	18.0	21.5	38.5	10.0	51
MS1205136-C	13	19.2	21.5	38.5	10.0	53
MS1205146-C	14	20.5	21.5	38.5	10.0	55
MS1205156-C	15	21.1	21.6	38.5	13.0	55
MS1205166-C	16	22.5	23.0	38.5	13.0	65
MS1205176-C	17	24.2	23.0	38.5	13.0	75
MS1205186-C	18	25.5	23.5	38.5	13.0	83
MS1205196-C	19	26.0	24.0	38.5	16.7	76
MS1205216-C	21	27.5	29.0	39.0	17.0	76
MS1205246-C	24	31.5	26.0	39.5	18.0	102

1/2" Drive Stainless Steel Metric Sockets →

1/2" Drive Deep Stainless Steel Sockets

1/2" drive stainless steel metric sockets deep, 6 point. Produced in accordance with DIN3120/3124/ISO2725. Satin finish and laser marked for brand and size. Ideal for the food, medical, aerospace and marine industries or for use in any acidic environment.

Stock No.	Size mm	D1 mm	D2 mm	L mm	T mm	Weight g
MS1206176-C	17	24.2	24.2	79	33	149
MS1206196-C	19	26.5	26.5	79	33	183
MS1206216-C	21	27.5	27.5	79	33	187

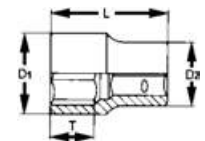
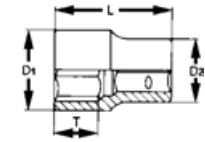

Impact sockets

An extensive range of impact sockets and accessories, especially designed for use together with pneumatic tools.

- Manufactured of chrome-molybdenum according to GGG-W-6608 to guarantee the highest material quality.
- Available with 1/4", 3/8", 1/2", 3/4" and 1" drives for all standard metric sizes and imperial sizes, from 6 mm to 95 mm and 7/16" to 1 1/2" with standard, deep and thin walled options.
- Full range of accessories including extension bars, adapter drives and universal joints.
- Can be ordered individually or in sets for DIN or ANSI standards to suit all applications within the workshop and automotive industry.
- All sockets are marked with the size for quick identification.
- The 1/2", 3/4", 1" and 1 1/2" versions in the DIN-standard are designed for use with a locking pin and ring to increase safety when working with pneumatic tools.
- A full range of bits for impact screwdrivers and bit holders are also included in the range.



IMPACT SOCKETS



3/8" Drive Impact Socket Sets

9381 3/8" drive impact Socket Set

Set containing 8 metric 3/8" drive 6 point impact sockets. Supplied on a clip rail.

Regular impact sockets	3/8" drive	6 point	8, 10, 11, 13, 14, 16, 17, 19mm
------------------------	------------	---------	---------------------------------



9386 3/8" drive deep impact Socket Set

Set containing 8 metric deep 3/8" drive 6 point impact sockets. Supplied on a clip rail.

Deep impact sockets	3/8" drive	6 point	8, 10, 11, 13, 14, 16, 17, 19mm
---------------------	------------	---------	---------------------------------



TT9024 1/4" & 3/8" drive impact socket set

24 piece set containing 1/4" drive regular and 3/8" drive regular and deep impact sockets plus an adaptor. Supplied in the unique Teng Tools TC tray with removable lid and dove tail joints for use on it's own or as part of the Teng Tools TC control system. (265x142x50mm, 1.07 kilos)

Accessories	3/8" drive	3/8"Fx1/4" adaptor	
Regular impact sockets	1/4" drive	6 point	6, 7, 8, 10, 13mm
Regular impact sockets	3/8" drive	6 point	8, 10, 11, 12, 13, 14, 16, 17, 19mm
Deep impact sockets	3/8" drive	6 point	8, 10, 11, 12, 13, 14, 16, 17, 19mm



1/2" Drive Impact Socket Sets

9121 1/2" drive impact Socket Set

Set containing 10 regular metric 1/2" drive 6 point impact sockets. Supplied on a clip rail. ANSI standard sockets suitable for automotive use.

Regular impact sockets	1/2" drive	6 point	10, 11, 12, 13, 14, 17, 19, 21, 22, 24mm
------------------------	------------	---------	--



9126 1/2" drive deep impact Socket Set

Set containing 10 deep metric 1/2" drive 6 point impact sockets. Supplied on a clip rail. ANSI standard sockets suitable for automotive use.

Deep impact sockets	1/2" drive	6 point	10, 11, 12, 13, 14, 17, 19, 21, 22, 24mm
---------------------	------------	---------	--



9207S12 1/2" Drive Stubby Impact Socket Set

Set containing 12 metric 1/2" drive stubby 6 point impact sockets. Supplied on a clip rail.

Stubby Impact sockets	1/2" drive	6 point	10, 12, 13, 14, 15, 16, 17, 18, 19, 21, 22, 24mm
-----------------------	------------	---------	--



TT9207 1/2" drive impact accessories

1/2" drive impact socket accessory set containing extension bars, universal joint and adaptors. For use with retaining pins and rings. Supplied in the unique Teng Tools TC tray with removable lid and dove tail joints for use on it's own or as part of the Teng Tools TC control system. (265x142x50mm, 1.05 kilos)

Adaptors		3/8"Fx1/2"M, 1/2"Fx3/4"M, 1/2"Fx3/8"M
Extension Bars	1/2" drive	3", 5" and 10
Universal Joint	1/2" drive	



TT9207A 1/2" drive impact accessories

1/2" drive impact socket accessory set containing extension bars, universal joint and adaptors. ANSI standard type impact accessories for automotive use. Supplied in the unique Teng Tools TC tray with removable lid and dove tail joints for use on it's own or as part of the Teng Tools TC control system. (265x142x50mm, 1.05 kilos)

Adaptors		3/8"Fx1/2"M, 1/2"Fx3/4"M, 1/2"Fx3/8"M
Extension Bars	1/2" drive	3", 5" and 10
Universal Joint	1/2" drive	



TT9116 1/2" drive impact socket set

Set containing 16 1/2" drive impact sockets, regular and deep. ANSI Standard suitable for automotive use. Supplied in the unique Teng Tools TC tray with removable lid and dove tail joints for use on it's own or as part of the Teng Tools TC control system. (265x142x50mm, 2.2 kilos)

Regular impact sockets	1/2" drive	6 point	13, 15, 16, 17, 18, 19, 22, 24mm
Deep impact sockets	1/2" drive	6 point	13, 15, 16, 17, 18, 19, 22, 24mm



TT9120D 1/2" drive impact socket set

Set containing 20 1/2" drive impact sockets, regular and deep plus locking pins and O-Rings. DIN Standard suitable for industrial use with retaining rings and pins. Supplied in the unique Teng Tools TC tray with removable lid and dove tail joints for use on it's own or as part of the Teng Tools TC control system. (265x142x50mm, 3.2 kilos)

Regular impact sockets	1/2" drive	6 point	13, 15, 16, 17, 18, 19, 22, 24mm
Deep impact sockets	1/2" drive	6 point	13, 15, 16, 17, 18, 19, 22, 24mm
Locking pins			20x3.5mm, 25x3.5mm
O-Rings			3x20mm, 3x24mm



T1206 1/2" drive XZN Spline impact bit socket set **NEW!**

Set containing six 1/2" drive impact socket bits. Chrome molybdenum with manganese phosphate finish for added corrosion resistance. Supplied in a storage case with snap lock and a metal pin hinge. (170x90x35mm, 0.64 kilos).

XZN impact bit sockets	1/2" drive	43mm length	14, 16, 18
XZN impact bit sockets	1/2" drive	78mm length	14, 16, 18



TT9212TX 1/2" drive impact TX bit socket set

Set containing 12 1/2" drive TX impact sockets. Suitable for use with retaining rings and pins. Supplied in the unique Teng Tools TC tray with removable lid and dove tail joints for use on it's own or as part of the Teng Tools TC control sytem. (265x142x50mm, 1.36 kilos)

TX impact sockets	1/2" drive	TX 10, 15, 20, 25, 27, 30, 40, 45, 50, 55, 60, 70
-------------------	------------	---



TT9015HX 3/8" & 1/2" drive impact hex bit socket set

15 piece 3/8" and 1/2" drive hex impact socket bit set. Supplied in the unique Teng Tools TC tray with removable lid and dove tail joints for use on it's own or as part of the Teng Tools TC control system. (265x142x50mm, 1.49 kilos)

Hex impact socket bits	3/8" drive	4, 5, 6, 7, 8, 10, 12mm
Hex impact socket bits	1/2" drive	5, 6, 8, 10, 12, 14, 17mm



TED9121 1/2" Drive Impact Socket Set

Set containing 1/2" drive regular and deep ANSI standard 6 point impact sockets and a range of accessories. Supplied in the unique Teng Tools double width TC tray with removable lid and dove tail joints for use on it's own or as part of the Teng Tools TC control system. The tools are held in place using the Teng Tools three colour pre-cut EVA foam tool control system. (265x284x50mm, 4.18 kilos)

Accessories	1/2" drive	3" and 10" extension bars, universal joint, 3/8"F:1/2"M Adaptor, 1/2"F:3/4"M adaptor
Regular sockets	1/2" drive 6 point	13, 15, 16, 17, 18, 19, 22, 24mm
Deep sockets	1/2" drive 6 point	13, 15, 16, 17, 18, 19, 22, 24mm



TTEISK73 3/8" & 1/2" drive Impact socket set

Set containing 3/8" and 1/2" drive regular and deep metric impact sockets and a comprehensive range of accessories. Supplied in the Teng Tools three colour pre-cut EVA foam tool control system. (570x375x75mm, 12.34 kilos)

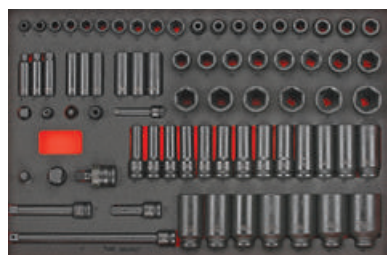

Accessories	3/8" drive	3" extension bar, 3/8"F:1/4"M adaptor, 3/8"F:1/2"M adaptor, coupler adaptor for 1/4" hex bits
Regular impact sockets	3/8" drive 6 point	8, 10, 11, 12, 13, 14, 15, 16, 17, 18, 19mm
Deep impact sockets	3/8" drive 6 point	8, 10, 11, 12, 13, 14, 16, 17, 19mm
Accessories	1/2" drive	3", 5" and 10" extension bars, universal joint, 1/2"F:3/8"M adaptor, 1/2" F:3/4"M adaptor, coupler adaptor for 5/16" hex bits
Regular impact sockets	1/2" drive 6 point	8, 10, 11, 12, 13, 14, 15, 16, 17, 18, 19, 20, 21, 22, 23, 24, 25, 26, 27, 28, 29, 30, 32mm
Deep impact sockets	1/2" drive 6 point	10, 11, 12, 13, 14, 15, 16, 17, 18, 19, 21, 22, 24, 27, 28, 29, 30, 32, 35, 36mm

TTTS08 Torque Stick Set

8 piece torque stick and wheel nut set, for tightening wheel nuts on cars. When the intended tightening torque is reached, the socket end stops while the drive end springs back between each stroke. Reduces the risk of sheared wheel bolts or deformed rims. Supplied in the unique Teng Tools TC tray with removable lid and dove tail joints for use on it's own or as part of the Teng Tools TC control system. (265x142x50mm, 2.0 kilos)

1/2" Torque sticks	Nm	90, 110, 120, 140
1/2" Wheel nut sockets	mm	17, 19, 21
Torque step up adaptor	inch	3/8 x 1/2



3/4" Drive Impact Socket Sets

TTD9416 3/4" drive impact socket set

3/4" drive impact socket set containing regular sockets 19 to 38mm, plus accessories including extension bar and retaining rings and pins. Supplied in the unique Teng Tools TC tray with removable lid and dove tail joints for use on it's own or as part of the Teng Tools TC control system. (265x284x50mm, 5.6kilos)

Accessories	3/4" drive	7" impact extension bar, 3 retaining rings, 3 retaining pins
Regular impact sockets	3/4" drive 6 point	19 (3/4"), 24, 27 (1 1/8"), 30 (1 1/4"), 32, 33, 34, 36, 38mm



TTX9415 3/4" drive impact socket set

15 piece set containing 15 metric regular and deep impact sockets to DIN standard. Suitable for use with retaining rings and pins. Supplied in the unique Teng Tools TTX tray for use on it's own or as part of the Teng Tools TXX control system. (570x115x60mm, 9.0 kilos)



Regular impact sockets	3/4" drive 6 point	19, 24, 27, 28, 30, 32, 34, 36mm
Deep impact sockets	3/4" drive 6 point	19 (3/4"), 24, 27 (1 1/8"), 30 (1 3/16"), 32, 33, 36mm

TTEISK33 3/4" drive impact socket set

Set containing 3/4" drive regular and deep metric impact sockets and a comprehensive range of accessories. Supplied in the Teng Tools three colour pre-cut EVA foam tool control system. (570x375x75mm, 20.92 kilos)

Accessories	3/4" drive	7" extension bar, universal joint, 3/4"F:1/2"M adaptor, 3/4"F:1"M adaptor
Regular impact sockets	3/4" drive 6 point	19, 21, 22, 23, 24, 27, 28, 30, 32, 33, 34, 36, 38, 41, 46mm
Deep impact sockets	3/4" drive 6 point	19, 21, 22, 23, 24, 27, 30, 32, 33, 34, 36, 38, 41, 46mm



1/2" Drive Impact Driver Sets

TTID20 1/2" drive impact driver set

Set containing 1/2" impact driver, coupler adaptor, 5/16"-3/8" hex adaptor as well as 17 bits. Supplied in the unique Teng Tools TC tray with removable lid and dove tail joints for use on it's own or as part of the Teng Tools TC control system. (265x142x50mm, 1.3 kilos)

Accessories	1/2" drive	reversible impact driver, coupler adaptor, 5/16" hex:3/8" M adaptor
Impact bits	5/16" drive	6mm flat, 8mm flat, 10mm flat, 12mm flat, PH1, PH2, PH3, PH4, 4mm hex, 5mm hex, 6mm hex, 8mm hex, TX30, TX40, TX45, TX50, TX55



TEDSD95 Torque Screwdriver, Impact Driver and Bit Set

1/4" drive 1-5Nm torque screwdriver and 1/2" drive impact driver together with assorted bits to suit most types of fastenings. Supplied in the unique Teng Tools double width TC tray with removable lid and dove tail joints for use on it's own or as part of the Teng Tools TC control system. The tools are held in place using the Teng Tools three colour pre-cut EVA foam tool control system. (265x284x50mm, 2.40 kilos)



Accessories	1/4" drive	1-5Nm torque screwdriver, quick release chuck, sliding T bar, 6" flexible extension, Ratchetting bits driver with assorted bits in the handle (5, 7mm flat, PH1, PH2, PZ1, PZ2, 1/4"M:1/4" hex adaptor)
	3/8" drive	3/8"M:5/16" hex adaptor
	1/2" drive	impact driver, 5/16" hex bit adaptor
5/16" hex 36mm bits	flat type	1.4x6, 1.4x6, 2.2x10, 1.8x12mm
	PH	PH1, PH2, PH3, PH4
	hex	4, 5, 6, 8mm
1/4" hex 25mm bits	TX	TX30, TX40, TX45, TX50, TX55
	flat type	0.6x3.5, 0.6x4.5, 0.8x4.0, 0.8x5.5, 1.0x5.5, 1.2x6.5, 1.6x8.0mm
	PH	PH1 (x3), PH2 (x6), PH3
	PZ	PZ1 (x3), PZ2 (x6), PZ3
	hex	2, 3, 4, 5, 6, 8mm
	TX	TX6, TX7, TX8, TX9, TX10, TX15, TX20 (x3), TX25 (x3), TX27, TX30, TX40
	TPX	TPX10, TPX15, TPX20 (x2), TPX25 (x2), TPX27, TPX30, TPX40
Square	1, 2, 3	
GR	2 (x3)	

ID506 1/2" drive impact driver set

Reversible action. Driver designed with 1/2" square drive, but also equipped with a chuck in which bits with 5/16" hex can be fitted. Supplied complete with chuck and four screwdriver bits for slotted heads and Phillips heads. Supplied in handy storage case. (195x66x45mm, 0.95 kilos)

Accessories	1/2" drive	Industrial quality reversible impact driver, impact coupler adaptor
Impact bits	5/16" hex	8x36mm flat, 10x36mm flat, PH2, PH3

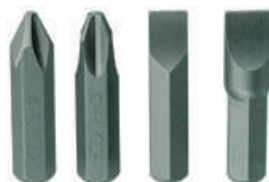

ID506BIT Impact driver bits

Bit set for impact driver set ID506.

Impact bits	5/16" hex	8x36mm flat, 10x36mm flat, PH2, PH3
-------------	-----------	-------------------------------------

ID515 1/2" drive impact driver set

Reversible action. Driver designed with 1/2" square drive, but also equipped with a chuck in which bits with 5/16" hex can be fitted. Supplied complete with 12 screwdriver bits for slotted heads, Phillips heads and internal hex screw heads. Supplied in a handy storage case. (223x115x52mm, 1,0 kilos)

Accessories	1/2" drive	Heavy duty reversible impact driver, impact coupler adaptor, 5/16" hex x 3/8" M adaptor
Impact bits	5/16" hex	6x36mm flat, 8x36mm flat, 10x36mm flat, 12x36mm flat, PH1, PH2, PH3, PH4, 4mm hex, 5mm hex, 6mm hex, 8mm hex



ID515BIT Impact driver set

Bit set for impact driver set ID515.

Impact bits	5/16" hex	6x36mm flat, 8x36mm flat, 10x36mm flat, 12x36mm flat, PH1, PH2, PH3, PH4, 4mm hex, 5mm hex, 6mm hex, 8mm hex, adaptor 5/16" hex:3/8" drive
-------------	-----------	--



Impact Bits

Impact bits 5/16" hex for use with 1/2" drive impact drivers.

Stock No.	Drive	Description	Length mm
910504	5/16" hex	4mm hex impact bit	36.0
910505	5/16" hex	5mm hex impact bit	36.0
910506	5/16" hex	6mm hex impact bit	36.0
910508	5/16" hex	8mm hex impact bit	36.0
910510	5/16" hex	10mm hex impact bit	36.0
920001	5/16" hex	PZ1 impact bit	36.0
920002	5/16" hex	PZ2 impact bit	36.0
920003	5/16" hex	PZ3 impact bit	36.0
940006	5/16" hex	6mm flat impact bit	36.0
940008	5/16" hex	8mm flat impact bit	36.0
940010	5/16" hex	10mm flat impact bit	36.0
940012	5/16" hex	12mm flat impact bit	36.0
930001	5/16" hex	PH1 impact bit	36.0
930002	5/16" hex	PH2 impact bit	36.0
930003	5/16" hex	PH3 impact bit	36.0
930004	5/16" hex	PH4 impact bit	36.0
970030	5/16" hex	TX30 impact bit	36.0
970040	5/16" hex	TX40 impact bit	36.0
970045	5/16" hex	TX45 impact bit	36.0
970050	5/16" hex	TX50 impact bit	36.0
970055	5/16" hex	TX55 impact bit	36.0



Impact Bits →

Impact Bits **NEW!**

A new range of 1/4" hex drive impact bits with a range of lengths that includes 30, 50 and 89mm. Available individually with the 30mm length range also available in packs of 5.

Impact bits – PH type

New design impact bits for higher torsion



Stock No.	Size	Drive	Pack qty	Length mm
PHP3000101	PH1	1/4" hex	1	30
PHP3000105	PH1	1/4" hex	5	30
PHP3000201	PH2	1/4" hex	1	30
PHP3000205	PH2	1/4" hex	5	30
PHP3000301	PH3	1/4" hex	1	30
PHP3000305	PH3	1/4" hex	5	30
PHP5000101	PH1	1/4" hex	1	50
PHP5000201	PH2	1/4" hex	1	50
PHP5000301	PH3	1/4" hex	1	50
PHP8900201	PH2	1/4" hex	1	89

Impact bits – GR type

New design impact bits for higher torsion



Stock No.	Size	Drive	Pack qty	Length mm
GRP3000201	GR2	1/4" hex	1	30
GRP3000205	GR2	1/4" hex	5	30
GRP5000201	GR2	1/4" hex	1	50

Impact bits – PZ type

New design impact bits for higher torsion



Stock No.	Size	Drive	Pack qty	Length mm
PZP3000101	PZ1	1/4" hex	1	30
PZP3000105	PZ1	1/4" hex	5	30
PZP3000201	PZ2	1/4" hex	1	30
PZP3000205	PZ2	1/4" hex	5	30
PZP3000301	PZ3	1/4" hex	1	30
PZP3000305	PZ3	1/4" hex	5	30
PZP5000101	PZ1	1/4" hex	1	50
PZP5000201	PZ2	1/4" hex	1	50
PZP5000301	PZ3	1/4" hex	1	50
PZP8900201	PZ2	1/4" hex	1	89

Impact bits – hex type

New design impact bits for higher torsion



Stock No.	Size	Drive	Pack qty	Length mm
HEXP3000301	3mm	1/4" hex	1	30
HEXP3000305	3mm	1/4" hex	5	30
HEXP3000401	4mm	1/4" hex	1	30
HEXP3000405	4mm	1/4" hex	5	30
HEXP3000501	5mm	1/4" hex	1	30
HEXP3000505	5mm	1/4" hex	5	30
HEXP3000601	6mm	1/4" hex	1	30
HEXP3000605	6mm	1/4" hex	5	30
HEXP5000301	3mm	1/4" hex	1	50
HEXP5000401	4mm	1/4" hex	1	50
HEXP5000501	5mm	1/4" hex	1	50
HEXP5000601	6mm	1/4" hex	1	50

Impact bits – TX type

New design impact bits for higher torsion



Stock No.	Size	Drive	Pack qty	Length mm
TXP3001001	TX10	1/4" hex	1	30
TXP3001005	TX10	1/4" hex	5	30
TXP3001501	TX15	1/4" hex	1	30
TXP3001505	TX15	1/4" hex	5	30
TXP3002001	TX20	1/4" hex	1	30
TXP3002005	TX20	1/4" hex	5	30
TXP3002501	TX25	1/4" hex	1	30
TXP3002505	TX25	1/4" hex	5	30
TXP3002701	TX27	1/4" hex	1	30
TXP3002705	TX27	1/4" hex	5	30
TXP3003001	TX30	1/4" hex	1	30
TXP3003005	TX30	1/4" hex	5	30
TXP3004001	TX40	1/4" hex	1	30
TXP3004005	TX40	1/4" hex	5	30
TXP5001001	TX10	1/4" hex	1	50
TXP5001501	TX15	1/4" hex	1	50
TXP5002001	TX20	1/4" hex	1	50
TXP5002501	TX25	1/4" hex	1	50
TXP5002701	TX27	1/4" hex	1	50
TXP5003001	TX30	1/4" hex	1	50
TXP5004001	TX40	1/4" hex	1	50
TXP8902001	TX20	1/4" hex	1	89
TXP8902501	TX25	1/4" hex	1	89
TXP8903001	TX30	1/4" hex	1	89



Impact bits – ROB type

New design impact bits for higher torsion



Stock No.	Size	Drive	Pack qty	Length mm
ROBP3000101	RS1	1/4" hex	1	30
ROBP3000105	RS1	1/4" hex	5	30
ROBP3000201	RS2	1/4" hex	1	30
ROBP3000205	RS2	1/4" hex	5	30
ROBP5000101	RS1	1/4" hex	1	50
ROBP5000201	RS2	1/4" hex	1	50
ROBP5000301	RS3	1/4" hex	1	50



Impact Accessories

Impact Accessories - 3/8" Drive

Stock No.	Drive	Description	Retaining ring	Retaining pin
980020-C	3/8"	3" impact extension bar. DIN standard	092416	P902515
980035-C	3/8"	3/8"F:1/4"M adaptor	092416	P902515
980036-C	3/8"	3/8"F:1/2"M adaptor. DIN standard	092416	P902515
980036A-C	3/8"	3/8"F:1/2"M adaptor. ANSI standard	-	-
980060-C	3/8"	Coupler adaptor for 1/4" hex	-	-
980086	3/8"	3/8"M:5/16"hex	-	-



Impact Accessories - 1/2" Drive

Stock No.	Drive	Description	Retaining ring	Retaining pin
920020-C	1/2"	3" impact extension bar. DIN standard	0935202	P90320
920020A-C	1/2"	3" impact extension bar. ANSI standard	-	-
920021-C	1/2"	5" impact extension bar. DIN standard	0935202	P90320
920021A-C	1/2"	5" impact extension bar. ANSI standard	-	-
920023-C	1/2"	10" impact extension bar. DIN standard	0935202	P90320
920023A-C	1/2"	10" impact extension bar. ANSI standard	-	-
920030-C	1/2"	impact universal joint. DIN standard	0935202	P90320
920030A-C	1/2"	impact universal joint. ANSI standard	-	-
920036-C	1/2"	impact 1/2"F:3/8"M adaptor. DIN standard	0935202	P90320
920036A-C	1/2"	impact 1/2"F:3/8"M adaptor. ANSI standard	-	-
920037-C	1/2"	impact 1/2"F:3/4"M adaptor. DIN standard	0935202	P90320
920037A-C	1/2"	impact 1/2"F:3/4"M impact adaptor. ANSI standard.	-	-
920060-C	1/2"	coupler adaptor for 5/16" hex	-	-



Impact Accessories →

Impact Accessories - 3/4" Drive

Stock No.	Drive	Description	Retaining ring	Retaining pin
940022-C	3/4"	7" impact extension bar	095036	P90435
940030-C	3/4"	impact universal joint	093538	P90437
940037-C	3/4"	impact 3/4"F:1/2"M adaptor	095036	P90435
940085-C	3/4"	impact 3/4"F:1"M adaptor	095036	P90435



Impact Accessories - 1" Drive

Stock No.	Drive	Description	Retaining ring	Retaining pin
910086	1"	impact 1"F:3/4"M adaptor	097045	P90545

Impact Accessories →

Stock No.	Description	Stock No.	Description
092416	Retaining ring 16x2.4mm	P902515	Retaining pin 2.5x15mm
092419	Retaining ring 19x2.4mm	P902518	Retaining pin 2.5x18mm
0935202	Retaining ring 20x3.5mm	P90320	Retaining pin 3x20mm
093525	Retaining ring 25x3.5mm	P90324	Retaining pin 3x24mm
093528	Retaining ring 28x3.5mm	P90328	Retaining pin 3x28mm
093530	Retaining ring 30x3.5mm	P90332	Retaining pin 3x32mm
093532	Retaining ring 32x3.5mm	P90437	Retaining pin 4x37mm
093534	Retaining ring 34x3.5mm	P90433	Retaining pin 4x33mm
095034	Retaining ring 34x5mm	P90435	Retaining pin 4x35mm
095036	Retaining ring 36x5mm	P90445	Retaining pin 4x45mm
093538	Retaining ring 38x3.5mm	P90543	Retaining pin 5x43mm
097043	Retaining ring 43x7mm	P90545	Retaining pin 5x45mm
097045	Retaining ring 45x7mm	P90551	Retaining pin 5x51mm
093546	Retaining ring 46x3.5mm	P90675	Retaining pin 6x75mm
095046	Retaining ring 46x5mm	P906110	Retaining pin 6x110mm
093548	Retaining ring 48x3.5mm		
097051	Retaining ring 51x7mm		
095775	Retaining ring 75x5.7mm		
0910075	Retaining ring 75x10mm		
09100115	Retaining ring 115x10mm		

Retaining Rings and Pins

Retaining rings and pins for use with DIN standard impact sockets and accessories.



Retaining Rings & Pins →

1/4" Drive Impact Sockets

1/4" Drive Metric Impact Sockets

1/4" drive impact sockets regular 6 point metric. Chrome molybdenum. DIN3129.

Stock No	Size mm	L mm	T mm	D1 mm	D2 mm	Weight g
960506-C	6	21.2	10.0	9.5	12.0	20
960507-C	7	21.2	11.0	11.0	12.0	20
960508-C	8	21.2	11.0	12.0	12.0	20
960510-C	10	21.2	12.5	14.0	12.0	30
960513-C	13	21.2	12.0	18.0	18.0	30

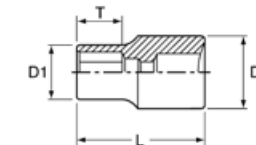

1/4" Drive Metric Impact Sockets →

3/8" Drive Impact Sockets

3/8" Drive Metric Impact Sockets

3/8" drive impact sockets regular 6 point metric. Chrome molybdenum.

Stock No	Size mm	L mm	T mm	D1 mm	D2 mm	Weight g
980508-C	8	30.0	8.0	12.5	19.0	33
980510-C	10	30.0	8.0	15.0	19.0	34
980511-C	11	30.0	9.0	17.0	19.0	37
980512-C	12	30.0	9.0	19.0	19.0	40
980513-C	13	30.0	9.0	19.0	19.0	41
980514-C	14	30.0	9.0	20.0	20.0	41
980515-C	15	30.0	11.0	22.0	22.0	64
980516-C	16	30.0	11.0	24.0	24.0	64
980517-C	17	30.0	11.0	24.0	24.0	64
980519-C	19	30.0	11.0	26.0	26.0	72

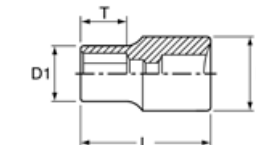

3/8" Drive Metric Impact Sockets →

3/8" Drive Deep Impact Sockets

3/8" drive impact sockets deep 6 point metric. Chrome molybdenum.

Stock No	Size mm	L mm	T mm	D1 mm	D2 mm	Weight g
980608-C	8	65.0	12.8	12.6	19.0	95
980610-C	10	65.0	26.0	15.2	19.0	89
980611-C	11	65.0	27.0	17.0	19.0	87
980612-C	12	65.0	27.0	19.0	19.0	85
980613-C	13	65.0	27.0	19.0	19.0	80
980614-C	14	65.0	27.0	20.0	20.0	87
980616-C	16	65.0	27.0	24.0	24.0	144
980617-C	17	65.0	27.0	24.0	24.0	130
980619-C	19	65.0	27.0	26.0	26.0	143

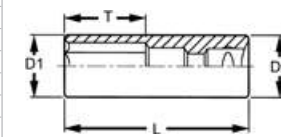

3/8" Drive Deep Impact Sockets →

3/8" Drive Hex Bit Impact Sockets

3/8" drive hex impact socket bits. Made of chrome molybdenum. With locking pin and retaining ring facility. DIN3129.

Stock No	Size mm	L1 mm	D1 mm	Weight g	Retaining Ring	Retaining Pin
981504-C	4	52.0	20.8	55	0935202	P90320
981505-C	5	52.0	20.8	57	0935202	P90320
981506-C	6	52.0	20.8	60	0935202	P90320
981507-C	7	52.0	20.8	63	0935202	P90320
981508-C	8	52.0	20.8	67	0935202	P90320
981510-C	10	52.0	20.8	74	0935202	P90320
981512-C	12	52.0	20.8	85	0935202	P90320



3/8" Drive Hex Bit Impact Sockets →

1/2" Drive Impact Sockets

1/2" Drive Metric Impact Sockets DIN Standard

1/2" drive impact sockets regular 6 point metric. Chrome molybdenum DIN standard for industrial use. DIN3129.

Stock No	Size mm	L mm	T mm	D1 mm	D2 mm	Weight g	Retaining Ring	Retaining Pin
920508-C	8	38.0	9.0	15.0	25.0	90	0935202	P90320
920510-C	10	38.0	12.0	17.5	25.0	90	0935202	P90320
920511-C	11	38.0	12.0	18.7	25.0	90	0935202	P90320
920512-C	12	38.0	12.0	20.0	25.0	90	0935202	P90320
920513-C	13	38.0	12.0	21.0	25.0	90	0935202	P90320
920514-C	14	38.0	12.0	22.5	25.0	90	0935202	P90320
920515-C	15	38.0	12.0	23.7	30.0	130	093525	P90324
920516-C	16	38.0	12.0	25.0	30.0	130	093525	P90324
920517-C	17	38.0	13.0	26.0	30.0	130	093525	P90324
920518-C	18	38.0	13.0	27.5	30.0	130	093525	P90324
920519-C	19	38.0	13.0	28.7	30.0	130	093525	P90324
920520-C	20	38.0	13.0	32.0	30.0	130	093525	P90324
920521-C	21	38.0	13.0	32.0	30.0	130	093525	P90324
920522-C	22	38.0	13.0	32.0	30.0	130	093525	P90324
920523-C	23	38.0	13.0	32.0	30.0	130	093525	P90324
920524-C	24	45.0	20.0	35.0	30.0	130	093525	P90324
920525-C	25	45.0	20.0	36.0	30.0	160	093525	P90324
920526-C	26	50.0	22.0	38.0	30.0	170	093525	P90324
920527-C	27	50.0	22.0	38.7	30.0	210	093525	P90324
920528-C	28	50.0	22.0	40.0	30.0	210	093525	P90324
920529-C	29	50.0	22.0	40.0	30.0	210	093525	P90324
920530-C	30	50.0	22.0	42.0	30.0	220	093525	P90324
920532-C	32	50.0	28.0	44.0	30.0	260	093525	P90324

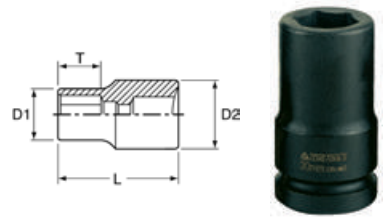

1/2" Drive Metric Impact Sockets DIN Standard →

1/2" Drive Metric Impact Sockets ANSI Standard

1/2" drive impact sockets regular 6 point metric. ANSI standard suitable for automotive use. Chrome molybdenum.

Stock No	Size mm	L mm	T mm	D1 mm	D2 mm	Weight g
920510A-C	10	38.0	12.0	17.0	22.0	69
920511A-C	11	38.0	12.0	18.0	22.0	69
920512A-C	12	38.0	12.0	19.0	22.0	69
920513A-C	13	38.0	12.0	19.0	24.0	90
920514A-C	14	38.0	12.0	22.0	24.0	83
920515A-C	15	38.0	12.0	21.0	25.0	130
920516A-C	16	38.0	12.0	25.0	25.0	130
920517A-C	17	38.0	12.0	26.0	26.0	130
920518A-C	18	38.0	13.0	26.0	26.0	130
920519A-C	19	38.0	13.0	28.0	28.0	130
920521A-C	21	38.0	13.0	30.0	30.0	127
920522A-C	22	38.0	13.0	32.0	32.0	130
920524A-C	24	45.0	13.0	34.0	34.0	150

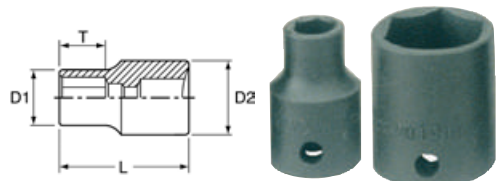

1/2" Drive Metric Impact Sockets →

1/2" Drive Stubby Metric Impact Sockets DIN standard design

1/2" drive 6 point impact sockets, short reach for use in confined spaces. Chrome molybdenum suitable for use with retaining rings and pins.

Stock No	Size mm	L mm	T mm	D1 mm	D2 mm	Weight g	Retaining Ring	Retaining Pin
920710-C	10	28	5.0	18	24	65	0935202	P90320
920712-C	12	28	5.0	20	24	65	0935202	P90320
920713-C	13	28	5.0	20	24	65	0935202	P90320
920714-C	14	28	5.0	22	24	65	0935202	P90320
920715-C	15	28	5.0	24	24	65	0935202	P90320
920716-C	16	28	5.0	24	24	66	0935202	P90320
920717-C	17	28	10.0	26	26	66	093525	P90320
920718-C	18	28	10.0	28	28	73	093525	P90320
920719-C	19	28	10.0	28	28	75	093525	P90320
920721-C	21	28	10.0	30	30	82	093525	P90324
920722-C	22	28	10.0	32	30	88	093525	P90324
920724-C	24	28	10.0	34	30	97	093525	P90324

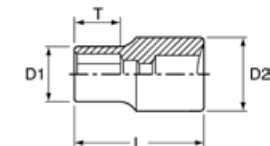

1/2" Drive Stubby Metric Impact Sockets →

1/2" Drive double ended sockets for wheel nuts

1/2" drive double ended impact sockets for wheel nuts

Stock No	Size mm	D1 mm	D2 mm	L mm
9291719	17/19	28	28	58
9292122	21/22	32	32	58

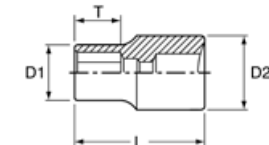

1/2" Drive For Wheel Nuts →

1/2" Drive AF Impact Sockets DIN Standard

1/2" drive impact sockets regular 6 point AF. Chrome molybdenum. DIN standard for industrial use.

Stock No	Size mm	L mm	T mm	D1 mm	D2 mm	Weight g	Retaining Ring	Retaining Pin
920114-C	7/16"	38.0	12.0	18.0	22.0	70	0935202	P90320
920116-C	1/2"	38.0	12.0	20.0	22.0	70	0935202	P90320
920118-C	9/16"	38.0	12.0	22.0	24.0	70	0935202	P90320
920120-C	5/8"	38.0	12.0	25.0	25.0	80	0935202	P90320
920122-C	11/16"	38.0	13.0	26.0	26.0	90	0935202	P90320
920124-C	3/4"	38.0	13.0	28.0	28.0	110	0935202	P90320
920126-C	13/16"	38.0	13.0	30.0	30.0	120	0935202	P90320
920128-C	7/8"	38.0	13.0	32.0	32.0	140	0935202	P90320
920130-C	15/16"	38.0	13.0	34.0	34.0	160	093530	P90328
920132-C	1"	38.0	14.0	36.0	36.0	180	093532	P90328
920136-C	1 1/8"	40.0	16.0	40.0	38.0	200	093532	P90328

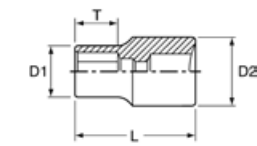

1/2" Drive AF Impact Sockets DIN Standard →

1/2" drive XZN Spline impact bit sockets

NEW!

1/2" drive impact bit sockets. Chrome molybdenum with manganese phosphate finish for added corrosion resistance.

Stock No	Size mm	L1 mm	L2 mm	D mm	Weight g
M121814-C	14	43.0	23.0	25.0	73.0
M121816-C	16	43.0	23.0	25.0	77.0
M121818-C	18	43.0	23.0	25.0	82.0
M123814-C	14	78.0	53.0	25.0	127.0
M123816-C	16	78.0	53.0	25.0	134.0
M123818-C	18	78.0	53.0	25.0	151.0

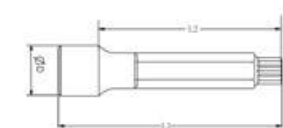

1/2" drive XZN Spline impact bit sockets →

Teng Tools

Teng Tools

1/2" Drive Deep Metric Impact Sockets DIN Standard

1/2" drive impact sockets deep 6 point metric. Chrome molybdenum. DIN standard suitable for industrial use. DIN3129.

Stock No	Size mm	L mm	T mm	D1 mm	D2 mm	Weight g	Retaining Ring	Retaining Pin
920610-C	10	78.0	14.0	17.5	25.0	180	0935202	P90320
920611-C	11	78.0	14.0	18.7	25.0	180	0935202	P90320
920612-C	12	78.0	14.0	20.0	25.0	180	0935202	P90320
920613-C	13	78.0	14.0	21.0	25.0	180	0935202	P90320
920614-C	14	78.0	17.0	22.5	25.0	180	0935202	P90320
920615-C	15	78.0	17.0	23.7	30.0	210	093525	P90324
920616-C	16	78.0	17.0	25.0	30.0	210	093525	P90324
920617-C	17	78.0	17.0	26.0	30.0	240	093525	P90324
920618-C	18	78.0	17.0	27.5	30.0	260	093525	P90324
920619-C	19	78.0	19.0	28.7	30.0	260	093525	P90324
920621-C	21	78.0	24.0	30.0	30.0	260	093525	P90324
920622-C	22	78.0	24.0	32.0	30.0	240	093525	P90324
920624-C	24	78.0	24.0	35.0	30.0	270	093525	P90324
920627-C	27	78.0	24.0	38.7	30.0	400	093525	P90324
920628-C	28	78.0	24.0	40.0	30.0	400	093525	P90324
920629-C	29	78.0	24.0	40.0	30.0	400	093525	P90324
920630-C	30	78.0	24.0	42.0	30.0	400	093525	P90324
920632-C	32	78.0	24.0	44.0	30.0	500	093525	P90324
920635-C	35	90.0	24.0	49.5	30.0	500	093525	P90324
920636-C	36	90.0	24.0	50.5	30.0	500	093525	P90324

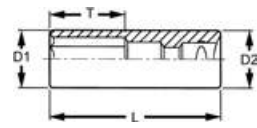

1/2" Drive Deep Metric Impact Sockets →

1/2" Drive Deep Metric Impact Sockets ANSI Standard

1/2" drive impact sockets deep 6 point metric. ANSI standard suitable for automotive use. Chrome molybdenum.

Stock No	Size mm	L mm	T mm	D1 mm	D2 mm	Weight g
920610A-C	10	78.0	14.0	17.0	22.0	157
920611A-C	11	78.0	14.0	18.0	22.0	157
920612A-C	12	78.0	14.0	19.0	22.0	157
920613A-C	13	78.0	18.0	20.0	24.0	174
920614A-C	14	78.0	18.0	22.0	24.0	177
920615A-C	15	78.0	18.0	24.0	24.0	177
920616A-C	16	78.0	18.0	24.0	24.0	168
920617A-C	17	78.0	18.0	26.0	26.0	198
920618A-C	18	78.0	18.0	26.0	26.0	198
920619A-C	19	78.0	20.0	28.0	28.0	231
920621A-C	21	78.0	24.0	30.0	30.0	257
920622A-C	22	78.0	25.0	32.0	32.0	297
920624A-C	24	78.0	26.0	34.0	34.0	332

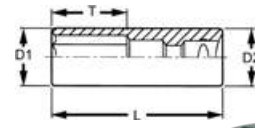

1/2" Drive Deep Metric Impact Sockets →

1/2" Drive AF Deep Impact Sockets DIN Standard

1/2" drive impact sockets deep 6 point AF. Chrome Molybdenum. DIN standard for industrial use.

Stock No	Size mm	L mm	T mm	D1 mm	D2 mm	Weight g	Retaining Ring	Retaining Pin
920214-C	7/16"	78.0	14.0	18.0	22.0	140	0935202	P90320
920216-C	1/2"	78.0	14.0	20.0	22.0	140	0935202	P90320
920218-C	9/16"	78.0	17.0	22.0	24.0	170	0935202	P90320
920220-C	5/8"	78.0	17.0	24.0	24.0	170	0935202	P90320
920222-C	11/16"	78.0	17.0	26.0	26.0	180	0935202	P90320
920224-C	3/4"	78.0	19.0	28.0	28.0	220	0935202	P90320
920226-C	13/16"	78.0	24.0	30.0	30.0	230	0935202	P90320
920228-C	7/8"	78.0	24.0	32.0	32.0	280	0935202	P90320
920230-C	15/16"	78.0	24.0	34.0	34.0	310	093530	P90328
920232-C	1"	78.0	24.0	36.0	36.0	350	093532	P90328
920242-C	1 1/8"	78.0	24.0	45.0	38.0	500	093534	P90332
920248-C	1 1/2"	78.0	24.0	52.5	38.0	500	093534	P90332

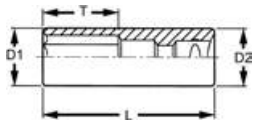

1/2" Drive AF Deep Impact Sockets →

1/2" Drive TX Impact Sockets

1/2" drive TX impact sockets regular. Chrome molybdenum.

Stock No	Size mm	L mm	D1 mm	D2 mm	Weight g	Retaining Ring	Retaining Pin
921210TX-C	10	78.0	6.5	25.0	73	0935202	P90320
921215TX-C	15	78.0	6.5	25.0	74	0935202	P90320
921220TX-C	20	78.0	6.5	25.0	74	0935202	P90320
921225TX-C	25	78.0	6.5	25.0	74	0935202	P90320
921227TX-C	27	78.0	6.5	25.0	78	0935202	P90320
921230TX-C	30	78.0	6.5	25.0	79	093525	P90324
921240TX-C	40	78.0	8.0	25.0	86	093525	P90324
921245TX-C	45	78.0	9.0	25.0	93	093525	P90324
921250TX-C	50	78.0	10.0	25.0	98	093525	P90324
921255TX-C	55	78.0	12.0	25.0	109	093525	P90324
921260TX-C	60	78.0	14.0	25.0	122	093525	P90324
921270TX-C	70	78.0	16.0	25.0	148	093525	P90324

1/2" Drive TX Impact Sockets →



1/2" Drive Hex Bit Impact Sockets

1/2" drive hex impact socket bits. Made of chrome molybdenum with locking pin and retaining ring facility. DIN3129.

Stock No.	Size mm	L1 mm	D1 mm	Weight g	Retaining Ring	Retaining Pin
921505-C	5	78.0	25.0	81	0935202	P90320
921506-C	6	78.0	25.0	86	0935202	P90320
921508-C	8	78.0	25.0	100	0935202	P90320
921510-C	10	78.0	25.0	114	0935202	P90320
921512-C	12	78.0	25.0	132	0935202	P90320
921514-C	14	78.0	25.0	155	0935202	P90320
921517-C	17	78.0	25.0	191	0935202	P90320
921519-C	19	78.0	25.0	216	0935202	P90320

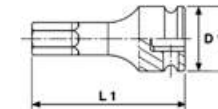

1/2" Drive Hex Bit Impact Sockets →

TTS08 Torque Stick Set

8 piece torque stick and wheel nut set, for tightening wheel nuts on cars. When the intended tightening torque is reached, the socket end stops while the drive end springs back between each stroke. Reduces the risk of sheared wheel bolts or deformed rims. Supplied in the unique Teng Tools TC tray with removable lid and dove tail joints for use on it's own or as part of the Teng Tools TC control system. (265x142x50mm, 2.0 kilos)

1/2" Torque sticks	Nm	90, 110, 120, 140
1/2" Wheel nut sockets	mm	17, 19, 21
Torque step up adaptor	inch	3/8 x 1/2



1/2" Drive Torque Sticks

1/2" drive torque sticks for tightening wheel nuts using percussive nut runners. When the intended tightening torque is reached the socket end stops while the drive end springs back between each stroke. Reduces the risk of sheared wheel bolts or deformed rims. Suitable for retaining rings and pins.

Stock No.	Drive	Torque Nm	Length mm	Retaining Ring	Retaining Pin
923090	1/2"	90	200	0935202	P90320
923110	1/2"	110	200	0935202	P90320
923120	1/2"	120	200	0935202	P90320
923140	1/2"	140	200	0935202	P90320

1/2" Drive Torque Sticks →



CLEAR FOR TAKE OFF ACCORDING TO TENG



RUBEN, Flight Engineer

When it comes to flying you don't want to gamble. You want perfectly tuned machinery. To get that, you need a perfectly tuned workshop. For some, things organised perfectly might seem boring, but when it comes to getting clear for take-off, it's vital. Welcome to our world!

Get organised™



3/4" Drive Impact Sockets

3/4" Drive Metric Impact Sockets

3/4" drive impact sockets regular 6 point metric, with locking pin and retaining ring facility. Chrome molybdenum.

Stock No.	Size mm	L mm	T mm	D1 mm	D2 mm	Weight g	Retaining Ring	Retaining Pin
940519-C	19	50.0	13.0	33.0	44.0	247	095036	P90435
940521-C	21	50.0	15.0	35.0	44.0	250	095036	P90435
940522-C	22	50.0	15.0	37.0	44.0	252	095036	P90435
940523-C	23	50.0	16.0	38.0	44.0	252	095036	P90435
940524-C	24	50.0	16.0	39.0	44.0	255	095036	P90435
940527-C	27	54.0	19.0	43.0	44.0	270	095036	P90435
940528-C	28	54.0	19.0	44.0	44.0	300	095036	P90435
940530-C	30	54.0	21.0	47.0	44.0	330	095036	P90435
940532-C	32	56.0	22.0	48.0	44.0	330	095036	P90435
940533-C	33	56.0	22.0	51.0	44.0	395	095036	P90435
940534-C	34	56.0	22.0	52.0	44.0	420	095036	P90435
940536-C	36	56.0	25.0	54.0	44.0	455	095036	P90435
940538-C	38	58.0	25.0	57.0	44.0	465	095036	P90435
940540-C	40	58.0	25.0	58.0	44.0	530	095036	P90435
940541-C	41	58.0	27.0	60.0	44.0	610	095036	P90435
940546-C	46	63.0	30.0	67.0	44.0	775	095036	P90435
940550-C	50	68.0	30.0	71.0	44.0	839	095036	P90435

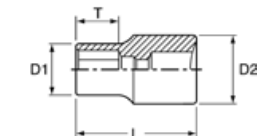

3/4" Drive Metric Impact Sockets →

3/4" Drive Deep Metric Impact Sockets

3/4" drive impact sockets deep 6 point metric with locking pin and retaining ring facility. Chrome molybdenum.

Stock No.	Size mm	L mm	T mm	D1 mm	D2 mm	Weight g	Retaining Ring	Retaining Pin
940619-C	19	95.0	31	33.0	44.0	595	095036	P90435
940621-C	21	95.0	31	35.0	44.0	610	095036	P90435
940622-C	22	95.0	31	37.0	44.0	620	095036	P90435
940623-C	23	95.0	31	38.0	44.0	630	095036	P90435
940624-C	24	95.0	31	39.0	44.0	640	095036	P90435
940627-C	27	95.0	31	43.0	44.0	680	095036	P90435
940630-C	30	95.0	33	47.0	44.0	720	095036	P90435
940632-C	32	95.0	33	49.0	44.0	870	095036	P90435
940633-C	33	95.0	34	51.0	44.0	860	095036	P90435
940634-C	34	95.0	34	52.0	44.0	810	095036	P90435
940636-C	36	95.0	36	54.0	44.0	830	095036	P90435
940638-C	38	95.0	36	57.0	44.0	920	095036	P90435
940641-C	41	95.0	36	58.0	44.0	790	095036	P90435
940646-C	46	95.0	36	67.0	44.0	900	095036	P90435
940650-C	50	95.0	36	71.0	44.0	1,227	095036	P90435

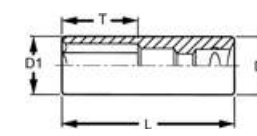

3/4" Drive Deep Metric Impact Sockets →

3/4" Drive Hex Bit Impact Sockets

3/4" drive impact hex socket bit, with locking pin and retaining ring facility. Chrome molybdenum.

Stock No.	Size mm	L mm	T mm	D1 mm	Weight g	Retaining Ring	Retaining Pin
941519-C	19	90.0	20.0	44.0	600	095036	P90435
941522-C	22	90.0	22.5	44.0	600	095036	P90435
941524-C	24	90.0	22.5	44.0	600	095036	P90435

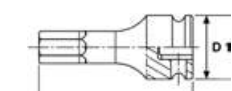

3/4" Drive Hex Bit Impact Sockets →

Teng Tools



940732-C 3/4" Drive Long Reach Impact Socket

400mm long 3/4" drive 32mm impact socket, ideal for wheel nuts on recessed truck wheels.

Stock No.	Size mm	L mm	T mm	D1 mm	D2 mm	Weight g	Retaining Ring	Retaining Pin
940732-C	32	400	22	48	44	1850	095036	P90435

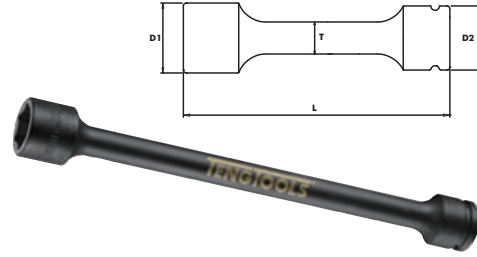

1" Drive Impact Sockets

1" Drive Regular Impact Sockets

1" drive impact sockets regular, metric with locking pin and retaining ring facility. DIN standard for industrial use.

Stock No.	Size mm	L mm	T mm	D1 mm	D2 mm	Weight g	Retaining Ring	Retaining Pin
910524	24	58.0	18.0	41.0	54.0	640	097045	P90545
910527	27	58.0	20.0	46.0	54.0	645	097045	P90545
910530	30	60.0	21.0	49.0	54.0	680	097045	P90545
910532	32	60.0	21.0	52.0	54.0	700	097045	P90545
910533	33	60.0	21.0	53.0	54.0	700	097045	P90545
910534	34	60.0	21.0	55.0	54.0	690	097045	P90545
910536	36	65.0	30.0	56.0	54.0	700	097045	P90545
910538	38	65.0	30.0	59.0	54.0	750	097045	P90545
910541	41	67.0	30.0	63.0	54.0	850	097045	P90545
910546	46	74.0	40.0	69.0	54.0	1005	097045	P90545
910550	50	80.0	43.0	74.0	54.0	1220	097045	P90545
910555	55	84.0	43.0	80.0	54.0	1470	097045	P90545
910560	60	87.0	46.0	86.0	54.0	1610	097045	P90545
910565	65	90.0	49.0	92.0	54.0	1890	097045	P90545
910570	70	96.0	51.0	99.0	54.0	2355	097045	P90545
910575	75	98.0	52.0	104.0	54.0	2455	097051	P90551
910580	80	100.0	52.0	109.0	86.0	3750	097051	P90551
910585	85	100.0	52.0	115.0	86.0	4750	0910075	P90675
910590	90	100.0	55.0	119.0	86.0	6000	0910075	P90675
910595	95	100.0	55.0	130.0	86.0	6500	097045	P90545

1" Drive Impact Sockets →

1" Drive Deep Thinwall Impact Sockets

1" drive impact sockets thinwall deep 6 point metric, with locking pin and retaining ring facility. Chrome molybdenum. DIN standard for industrial use.

Stock No.	Size mm	L mm	T mm	D1 mm	D2 mm	Weight g	Retaining Ring	Retaining Pin
910624	24	100.0	28.0	38.0	54.0	830	097045	P90545
910627	27	100.0	28.0	43.0	54.0	895	097045	P90545
910628	28	100.0	28.0	43.0	54.0	895	097045	P90545
910630	30	100.0	42.0	45.0	54.0	945	097045	P90545
910632	32	100.0	45.0	47.0	54.0	935	097045	P90545
910633	33	100.0	45.0	49.0	54.0	980	097045	P90545
910636	36	100.0	66.0	52.0	54.0	870	097045	P90545

1" Drive Impact Sockets →

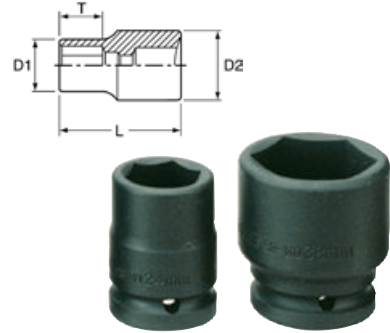

1" Drive Deep Impact Sockets

1" drive impact sockets deep 6 point metric, with locking pin and retaining ring facility. Chrome molybdenum.

Stock No.	Size mm	L mm	T mm	D1 mm	D2 mm	Weight g	Retaining Ring	Retaining Pin
910627R	27	100.0	50.0	46.0	54.0	990	097045	P90545
910630R	30	100.0	50.0	50.0	54.0	1040	097045	P90545
910632R	32	100.0	50.0	52.0	54.0	1060	097045	P90545
910633R	33	100.0	50.0	53.0	54.0	1070	097045	P90545

1" Drive Impact Sockets →



910732 1" Drive Long Reach Impact Socket

400mm long 1" drive 32mm impact socket, ideal for wheel nuts on recessed truck wheels.

Stock No.	Size mm	L mm	T mm	D1 mm	D2 mm	Weight g	Retaining Ring	Retaining Pin
910732	32	270	28	48	54	1840	097045	P90545

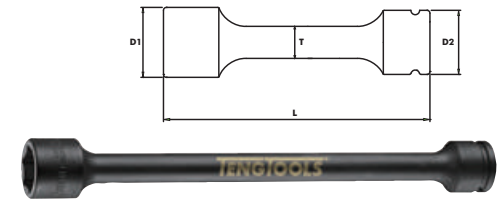

1 1/2" Drive Metric Impact Sockets

1 1/2" Drive Metric Impact Sockets

1 1/2" drive impact sockets, regular, metric with locking pin and retaining ring facility.

Stock No.	Size mm	L mm	T mm	D1 mm	D2 mm	Weight g	Retaining Ring	Retaining Pin
912041	41	80.0	27.0	69.0	86.0	1,800	0910075	P90675
912046	46	84.0	29.0	75.0	86.0	2,000	0910075	P90675
912050	50	87.0	30.0	80.0	86.0	2,400	0910075	P90675
912055	55	90.0	32.0	86.0	86.0	2,600	0910075	P90675
912060	60	95.0	35.0	91.0	86.0	2,870	0910075	P90675
912065	65	100.0	38.0	100.0	86.0	3,230	0910075	P90675
912070	70	105.0	40.0	104.0	86.0	3,670	0910075	P90675
912075	75	105.0	42.0	105.0	86.0	4,000	0910075	P90675
912080	80	110.0	46.0	116.0	86.0	4,300	0910075	P90675
912085	85	110.0	46.0	123.0	86.0	4,600	0910075	P90675
912090	90	112.0	48.0	129.0	86.0	5,100	0910075	P90675
912095	95	112.0	48.0	136.0	127.0	7,700	09100115	P906110
912100	100	115.0	50.0	142.0	127.0	8,200	09100115	P906110
912105	105	120.0	52.0	148.0	127.0	8,600	09100115	P906110
912110	110	124.0	54.0	154.0	127.0	9,100	09100115	P906110
912115	115	128.0	56.0	161.0	127.0	10,300	09100115	P906110
912120	120	132.0	58.0	167.0	127.0	11,500	09100115	P906110
912125	125	136.0	60.0	173.0	127.0	12,500	09100115	P906110
912130	130	140.0	60.0	180.0	127.0	13,500	09100115	P906110





Combination spanners

- Manufactured and designed in accordance with DIN3113A in high grade chrome vanadium steel.
- The ring head is offset 15 degrees to facilitate use even on flat surfaces.
- All ring heads are equipped with Teng Tools "hip grip" system, which means the contact surface grips on the flat surfaces of the nut or bolt head rather than on the corner. This system helps to prevent damage to nuts and bolts and makes it possible to grip nuts and bolts which already have damaged corners.



Newly developed series of non slip combination spanners

- The ring head is offset 15 degrees and is also countersunk so you can gain access in confined areas.
- The ring head is equipped with Teng Tools "hip grip" system that prevents damage to nuts and makes it possible to grip already damaged nuts.
- Hole in the handle for tool securing.
- The design of the shaft ensures an improved grip to avoid slipping and cause injury.
- The new design includes an anti-slip grip at the open end.



Ring ratchet spanners

- Ratchet spanners with 15 degree offset head for easier use against flat surfaces.
- Lever for quick reversing between left and right-hand action.
- 72 teeth give an arc of 5 degrees for smooth handling.



Ring ratchet spanners with flexible head

- Ring ratchet spanner with 180 degree flexible pivot to gain access to even the most hard to reach nuts and bolts.
- 72 teeth give an arc of 5 degrees for smooth operation.

SPANNERS

A range that has been developed over many years with DIN and ISO standards as the lowest benchmark when it concerns quality and size tolerances. This is a policy that has resulted in many top positions on best-buy lists in consumer and trade magazines. The range includes many different types of spanners for most application areas and personal taste. All spanners are available individually as well as in TT sets, tool pouches or wall holders.

TT8012 Anti slip Combination Spanner Set

12 piece metric combination spanner set featuring a typically Teng new design in combination spanners that gives an anti slip grip on the open end as well as the Teng Tools hip grip function where the spanner drives on the flank of the fastening rather than the corner, two design features that combine to give a much better grip with much less risk of damage to the fastening. The design also gives grip on fastenings with worn or rounded corners. Supplied in the unique Teng Tools TC tray with removable lid and dove tail joints for use on it's own or as part of the Teng Tools TC control system. (265x142x50mm, 1.2 kilos)

Combination spanners 8, 9, 10, 11, 12, 13, 14, 15, 16, 17, 18, 19mm



TED8012 Anti slip Combination Spanner Set

12 piece metric combination spanner set featuring a typically Teng new design in combination spanners that gives an anti slip grip on the open end as well as the Teng Tools hip grip function where the spanner drives on the flank of the fastening rather than the corner, two design features that combine to give a much better grip with much less risk of damage to the fastening. The design also gives grip on fastenings with worn or rounded corners. Supplied in the unique Teng Tools double width TC tray with removable lid and dove tail joints for use on it's own or as part of the Teng Tools TC control system. The tools are held in place using the Teng Tools three colour pre-cut EVA foam tool control system. (265x284x50mm, 1.50 kilos)

Combination spanners 8, 9, 10, 11, 12, 13, 14, 15, 16, 17, 18, 19mm



WR8012 Anti slip Combination Spanner Set

12 piece metric combination spanner set featuring a typically Teng new design in combination spanners that gives an anti slip grip on the open end as well as the Teng Tools hip grip function where the spanner drives on the flank of the fastening rather than the corner, two design features that combine to give a much better grip with much less risk of damage to the fastening. The design also gives grip on fastenings with worn or rounded corners. Complete with a wall rack for fixing to the wall or a work bench.

Combination spanners 8, 9, 10, 11, 12, 13, 14, 15, 16, 17, 18, 19mm

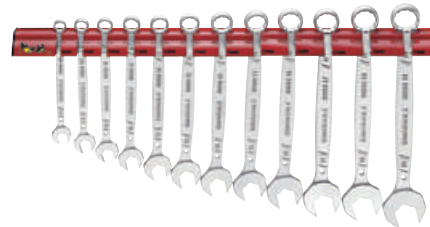

TT1236 Metric combination spanner set

12 piece metric spanner set, chrome vanadium steel. Same dimension at both ends. The 12 point ring head is set at a 15° angle. Polished heads. Satin finish. Supplied in the unique Teng Tools TC tray with removable lid and dove tail joints for use on it's own or as part of the Teng Tools TC control system. (265x142x50mm, 1.7 kilos)

Combination spanners 8, 9, 10, 11, 12, 13, 14, 15, 16, 17, 18, 19mm



TT3592 AF Combination spanner set

8 piece AF spanner set, chrome vanadium steel. Same dimension at both ends. The 12 point ring head is set at a 15° angle. Polished heads. Satin finish. Supplied in the unique Teng Tools TC tray with removable lid and dove tail joints for use on it's own or as part of the Teng Tools TC control system. (265x142x50mm, 1.0 kilos)

Combination spanners 5/16" 3/8" 7/16" 1/2" 9/16" 5/8" 11/16" 3/4"



TTX2032 Metric combination spanner set

7 piece metric combination spanner set ranging from 20 to 32mm. Chrome vanadium steel. The 12 point ring head is angled at a 15° angle. Satin finish. Supplied in the unique Teng Tools TTX tray for use on it's own or as part of the Teng Tools TC control system. (570x115x60mm, 2.6 kilos)



Combination spanners 20, 21, 22, 24, 27, 30, 32mm

TTX2640 AF combination spanner set

7 piece combination spanner set ranging from 13/16" to 1 1/4". Chrome vanadium steel. The 12 point ring head is angled at a 15° angle. Satin finish. Supplied in the unique Teng Tools TTX tray for use on it's own or as part of the Teng Tools TC control system. (570x115x72mm, 2.6 kilos)



Combination spanners 13/16" 7/8" 15/16" 1" 1 1/4" 1 1/4" 1 1/4"

WRSP12 Combination Spanner Set

12 piece metric combination spanner set. Satin finish. Chrome vanadium. Complete with a wall rack for fixing to the wall or a work bench.

Combination spanners 8, 9, 10, 11, 12, 13, 14, 15, 16, 17, 18, 19mm



TED6515 Combination Spanner Set

15 piece metric combination spanner set covering 5.5 to 19mm. Supplied in the unique Teng Tools double width TC tray with removable lid and dove tail joints for use on it's own or as part of the Teng Tools TC control system. The tools are held in place using the Teng Tools three colour pre-cut EVA foam tool control system. (265x284x50mm, 1.61 kilos)

Combination spanners 5.5, 6, 7, 8, 9, 10, 11, 12, 13, 14, 15, 16, 17, 18, 19mm



TEX2032 Combination Spanner Set

7 piece metric combination spanner set covering 20 to 32mm. Supplied in the unique Teng Tools drawer width TTX tray for use on it's own or as part of the Teng Tools TC control system. The tools are held in place using the Teng Tools three colour pre-cut EVA foam tool control system. (570x115x60mm, 2.77 kilos)



Combination spanners 20, 21, 22, 24, 27, 30, 32mm

TTESP31 Metric combination spanner set

Set containing metric combination spanners covering 5.5mm to 38mm. Supplied in the Teng Tools three colour pre-cut EVA foam tool control system. (570x375x75mm, 8.47 kilos)



Combination spanners	5.5, 6, 7, 8, 9, 10, 11, 12, 13, 14, 15, 16, 17, 18, 19, 20, 21, 22, 23, 24, 25, 26, 27, 28, 29, 30, 32, 33, 34, 36, 38mm
----------------------	---

TTESP37 Metric spanner set

Set containing metric ratcheting combination spanners, metric double open ended spanners and double ring spanners. Supplied in the Teng Tools three colour pre-cut EVA foam tool control system. (570x375x75mm, 7.62 kilos)

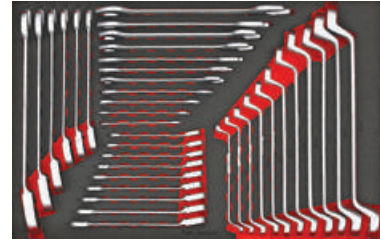

Ratcheting combination spanners	8, 9, 10, 11, 12, 13, 14, 15, 16, 17, 18, 19, 22, 24, 27mm
Double open ended spanners	6x7, 8x9, 10x11, 12x13, 14x15, 16x17, 18x19, 20x22, 21x23, 24x27, 30x32mm
Double ring spanners	6x7, 8x9, 10x11, 12x13, 14x15, 16x17, 18x19, 20x22, 21x23, 24x27, 30x32mm

TTEX32 32 piece spanner and file set

Set containing a complete range of combination spanners, ratcheting combination spanners and engineers files. Supplied in the Teng Tools three colour pre-cut EVA foam tool control system. (570x375x50mm, 5.65 kilos)



Combination spanners	8, 9, 10, 11, 12, 13, 14, 15, 16, 17, 18, 19, 20, 21, 22, 24, 27, 30, 32mm
Ratcheting combination spanners	8, 10, 11, 12, 13, 14, 17, 19mm
10" engineers files	flat, round, half round, three square and hand type flat

TTEAF62 AF socket & spanner set

Set containing AF combination spanners and socketry covering 3/16" to 1 1/4". Supplied in the Teng Tools three colour pre-cut EVA foam tool control system. (570x375x75mm, 5.9 kilos)



Combination spanners	inch		5/16"	3/8"	7/16"	1/2"	9/16"	5/8"	11/16"	3/4"	13/16"	7/8"	15/16"	1"	1 1/16"	1 1/8"	1 1/4"
Regular sockets	1/4" drive	6 point	3/16"	7/32"	1/4"	9/32"	5/16"	11/32"	3/8"	7/16"	1/2"						
Deep sockets	1/4" drive	6 point	3/16"	7/32"	1/4"	9/32"	5/16"	11/32"	3/8"	7/16"	1/2"						
Regular sockets	3/8" drive	6 point	3/8"	7/16"	1/2"	9/16"	5/8"	11/16"	3/4"								
Deep sockets	3/8" drive	6 point	3/8"	7/16"	1/2"	9/16"	5/8"	11/16"	3/4"								
Regular sockets	1/2" drive	12 point	3/8"	7/16"	1/2"	9/16"	5/8"	11/16"	3/4"	13/16"	7/8"	15/16"	1"	1 1/16"	1 1/8"	1 1/4"	

8512MM Anti Slip Combination Spanner Set

12 piece metric combination spanner set featuring a typically Teng new design in combination spanners that gives an anti slip grip on the open end as well as the Teng Tools hip grip function where the spanner drives on the flank of the fastening rather than the corner, two design features that combine to give a much better grip with much less risk of damage to the fastening. The design also gives grip on fastenings with worn or rounded corners. Supplied in a handy tool roll.



Combination spanners	8, 9, 10, 11, 12, 13, 14, 15, 16, 17, 18, 19mm
----------------------	--

8512A Anti Slip Combination Spanner Set

12 piece metric combination spanner set featuring a typically Teng new design in combination spanners that gives an anti slip grip on the open end as well as the Teng Tools hip grip function where the spanner drives on the flank of the fastening rather than the corner, two design features that combine to give a much better grip with much less risk of damage to the fastening. The design also gives grip on fastenings with worn or rounded corners. Supplied in a handy fold out storage case with magnetic fixing.



Combination spanners	8, 9, 10, 11, 12, 13, 14, 15, 16, 17, 18, 19mm
----------------------	--

6510A Combination Spanner Set

A set of 10 metric combination spanners. Chrome vanadium. Satin Finish. In a plastic holder for carrying away or fixing on the wall or on a work bench panel. DIN 3113A.



Combination spanners	8, 10, 11, 12, 13, 14, 15, 16, 17, 19mm
----------------------	---

6510MM Combination Spanner Set

10 piece metric combination spanner set with the same dimension at both ends. The 12 point ring end is set at 15 angle. Polished heads with satin finish. Supplied in a handy tool roll.



Combination spanners	8, 9, 10, 11, 12, 13, 14, 15, 17, 19mm
----------------------	--

6512N 12 Piece Combination spanner set

12 piece metric combination spanner set with the same dimension at both ends. The 12 point ring end is set at a 15° angle. Polished heads with satin finish. Supplied in a coloured display box only.

Combination spanners	8, 9, 10, 11, 12, 13, 14, 15, 16, 17, 18, 19mm
----------------------	--

**6512 12 Piece Combination Spanner Set**

12 piece metric combination spanner set with the same dimension at both ends. The 12 point ring end is set at a 15° angle. Polished heads with satin finish. Supplied in a coloured display box only.

Combination spanners	8, 9, 10, 11, 12, 13, 14, 15, 16, 17, 19, 22mm
----------------------	--

**6512MM1 Combination spanner set**

12 piece metric combination spanner set with the same dimension at both ends. The 12 point ring end is set at a 15° angle. Polished heads with satin finish. Supplied in a handy tool roll.

Combination spanners	8, 9, 10, 11, 12, 13, 14, 15, 16, 17, 18, 19mm
----------------------	--

**6515MM Combination Spanner Set**

15 piece metric combination spanner set with the same dimension at both ends. The 12 point ring head is set at a 15° angle. Polished heads with satin finish. Supplied in a handy tool roll.

Combination spanners	5.5, 6, 7, 8, 9, 10, 11, 12, 13, 14, 15, 16, 17, 18, 19mm
----------------------	---

**6517MM Combination Spanner Set**

17 piece metric combination spanner set with the same dimension at both ends. The 12 point ring head is set at a 15° angle. Polished heads with satin finish. Supplied in a handy tool roll.

Combination spanners	6, 7, 8, 9, 10, 11, 12, 13, 14, 15, 16, 17, 18, 19, 20, 21, 22mm
----------------------	--

6517 17 Piece Combination spanner set

17 piece metric combination spanner set with the same dimension at both ends. The 12 point ring end is set at a 15° angle. Polished heads with satin finish. Supplied in a coloured display box only.

Combination spanners	6, 7, 8, 9, 10, 11, 12, 13, 14, 15, 16, 17, 18, 19, 20, 21, 22mm
----------------------	--

**6512MM Combination Spanner Set**

12 piece metric combination spanner set with the same dimension at both ends. The 12 point ring head is set at a 15° angle. Polished heads with satin finish. Supplied in a handy tool roll.

Combination spanners	20, 21, 22, 23, 24, 25, 26, 27, 28, 29, 30, 32mm
----------------------	--

**6521 21 Piece Combination spanner set**

21 piece metric combination spanner set with the same dimension at both ends. The 12 point ring end is set at a 15° angle. Polished heads with satin finish. Supplied in a coloured display box only.

Combination spanners	6, 7, 8, 9, 10, 11, 12, 13, 14, 15, 16, 17, 18, 19, 20, 21, 22, 24, 27, 30, 32mm
----------------------	--

**6526MM Combination spanner set**

26 piece metric combination spanner set with the same dimension at both ends. The 12 point ring head is set at a 15° angle. Polished heads with satin finish. Supplied in a handy tool roll.

Combination spanners	6, 7, 8, 9, 10, 11, 12, 13, 14, 15, 16, 17, 18, 19, 20, 21, 22, 23, 24, 25, 26, 27, 28, 29, 30, 32mm
----------------------	--

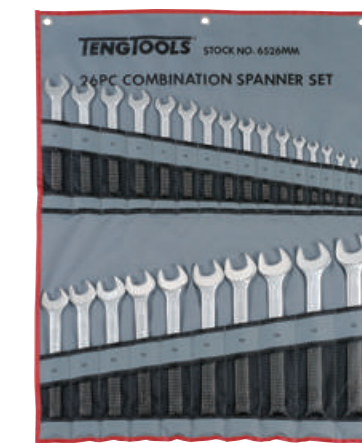

6507JMM Combination Spanner Set

7 piece metric combination spanner set with the same dimension at both ends. The 12 point ring head is set at a 15° angle. Polished heads with satin finish. Supplied in a handy tool roll.

Combination spanners 33, 34, 36, 38, 41, 46, 50mm



6509AF Combination Spanner Set

9 piece AF combination spanner set with the same dimension at both ends. The 12 point ring head is set at a 15° angle. Polished heads with satin finish. Supplied in a handy tool roll.

Combination spanners 1/4" 5/16" 3/8" 7/16" 1/2" 9/16" 5/8" 11/16" 3/4"



6507AF Combination Spanner Set

7 piece AF combination spanner set with the same dimension at both ends. The 12 point ring head is set at a 15° angle. Polished heads with satin finish. Supplied in a handy tool roll.

Combination spanners 13/16" 7/8" 15/16" 1" 1 1/8" 1 1/4"



6507JAF Combination Spanner Set

7 piece AF combination spanner set with the same dimension at both ends. The 12 point ring head is set at a 15° angle. Polished heads with satin finish. Supplied in a handy tool roll.

Combination spanners 1 5/8" 1 3/4" 1 7/8" 1 1/2" 1 3/4", 1 3/4", 1 3/4"



6515MMA Combination Spanner Set

15 piece metric combination spanner set with the same dimension at both ends. The 12 point ring head is set at a 15° angle. Polished heads with satin finish. Supplied in a special holder so that it can be connected with set 6512MMA.

Combination spanners 5.5, 6, 7, 8, 9, 10, 11, 12, 13, 14, 15, 16, 17, 18, 19mm

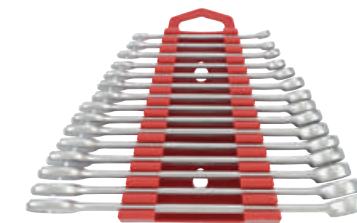

6512MMA Combination Spanner Set

12 piece metric combination spanner set with the same dimension at both ends. The 12 point ring head is set at a 15° angle. Polished heads with satin finish. Supplied in a special holder so that it can be connected with sets 6515MMA and 6507JMM.

Combination spanners 20, 21, 22, 23, 24, 25, 26, 27, 28, 29, 30, 32mm

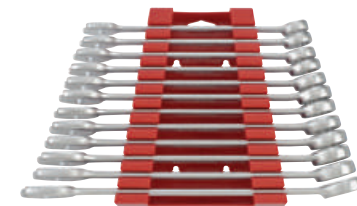

6507JMM A Combination Spanner Set

7 piece metric combination spanner set with the same dimension at both ends. The 12 point ring head is set at a 15° angle. Polished heads with satin finish. Supplied in a special holder so that it can be connected with set 6512MMA.

Combination spanners 33, 34, 36, 38, 41, 46, 50mm



Non slip combination spanners

A typically Teng new design in combination spanners that gives an anti slip grip on the open end as well as the Teng Tools hip grip function where the spanner drives on the flank of the fastening rather than the corner, two design features that combine to give a much better grip with much less risk of damage to the fastening. The design also gives grip on fastenings with worn or rounded corners.

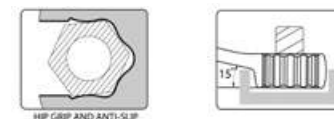

Stock no.	Size	L	H1	H2	D1	D2	T	Weight
		mm	mm	mm	mm	mm	mm	g
800608	8	120	6.6	4.5	12.8	18.9	3.2	24
800609	9	130	7.0	4.5	14.2	20.8	3.2	28
800610	10	140	7.7	5.0	15.6	22.5	3.6	36
800611	11	150	8.4	5.4	16.9	24.5	3.6	46
800612	12	160	8.5	5.5	18.0	27.2	3.6	58
800613	13	170	8.8	5.9	19.5	29.6	3.9	71
800614	14	180	9.6	6.2	21.5	31.1	4.0	81
800615	15	185	10.1	6.4	22.8	32.5	4.2	93
800616	16	195	10.5	6.5	24.2	35.0	4.5	110
800617	17	202	11.0	6.9	25.2	37.0	4.5	123
800618	18	208	11.5	7.1	26.8	39.0	4.8	135
800619	19	218	12.2	7.5	28.4	41.1	5.0	156

Non slip combination spanners →

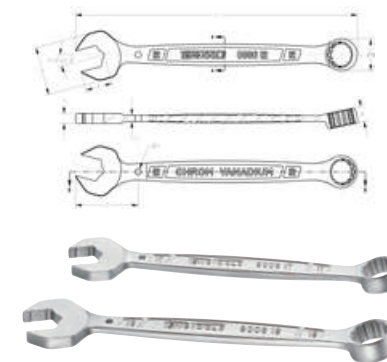

Metric Combination Spanners

Combination Spanners, Metric, DIN 3113A, Offset 15 degrees, Chrome vanadium. Satin Finish. Same dimension at both ends. The 12 point ring end is set at a 15° angle.

Stock no.	Size	L	H1	H2	D1	D2	T	Weight
	mm	mm	mm	mm	mm	mm	mm	g
6005055	5.5	95	4.1	3.5	8.9	13.6	2.4	11
600506	6	100	4.7	4.0	10.1	15.5	2.7	17
600507	7	110	5.0	4.0	11.5	17.0	2.8	23
600508	8	120	5.5	4.5	12.8	19.2	3.0	25
600509	9	130	5.9	4.5	14.2	21.2	3.3	28
600510	10	140	6.5	5.0	15.6	23.2	3.5	38
600511	11	150	6.9	5.4	16.9	25.3	3.7	47
600512	12	160	7.3	5.5	18.3	27.2	3.9	60
600513	13	170	7.8	5.9	19.7	29.4	4.1	68
600514	14	180	8.3	6.2	21.2	31.5	4.4	84
600515	15	190	8.6	6.4	22.5	33.2	4.6	98
600516	16	200	8.9	6.7	24.0	34.7	4.8	104
600517	17	210	9.3	6.9	25.3	36.5	5.0	124
600518	18	220	9.9	7.2	26.8	38.7	5.2	141
600519	19	230	10.5	7.4	28.1	40.7	5.4	158
600520	20	240	10.9	7.7	29.7	43.1	5.6	184
600521	21	250	11.3	8.0	31.3	44.8	5.7	209
600522	22	260	11.5	8.2	32.6	46.9	5.8	216
600523	23	270	11.8	8.4	34.2	48.3	5.9	258
600524	24	280	12.1	8.7	35.5	50.4	6.0	265
600525	25	290	12.5	8.9	36.9	52.0	6.2	296
600526	26	300	12.8	9.2	38.2	53.6	6.4	342
600527	27	310	13.1	9.4	39.6	55.7	6.6	385
600528	28	320	13.3	9.7	40.9	57.6	6.8	397
600529	29	330	13.5	9.9	42.3	59.7	7.0	435
600530	30	340	13.7	10.1	43.7	61.8	7.1	459
600532	32	360	14.3	10.4	46.4	65.8	7.3	527
600533	33	380	15.0	10.7	48.8	69.2	7.5	654
600534	34	380	15.0	10.7	48.8	69.2	7.5	674
600536	36	410	19.2	13.5	53.5	74.0	8.0	831
600538	38	430	20.4	15.0	56.0	77.0	9.0	967
600541	41	460	21.6	16.0	61.0	84.0	10.0	1257
600546	46	500	23.0	17.0	66.0	92.0	11.0	1693
600550	50	540	24.6	18.0	73.0	102.0	12.0	2048
600555	55	560	21.5	28.0	86.0	118.0	14.5	2800
600558	58	600	23.5	30.0	94.0	126.0	16.0	3900
600560	60	600	23.5	30.0	94.0	126.0	16.0	3900
600565	65	680	25.0	32.0	108.0	148.0	18.0	5800
600570	70	680	25.0	32.0	108.0	148.0	18.0	5800

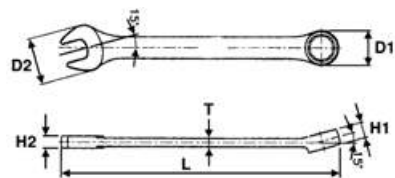

Metric Combination Spanners →

AF Combination Spanners

Combination Spanners, AF (SAE), DIN 3113A. Chrome vanadium. Satin Finish. Same dimension at both ends. The 12 point ring is at a 15° angle.

Stock no.	Size	L	H1	H2	D1	D2	T	Weight
	mm	mm	mm	mm	mm	mm	mm	g
600108	1/4"	100	4.7	4.0	10.1	15.5	2.7	16
600110	5/16"	120	5.5	4.5	12.8	19.2	3.0	25
600112	3/8"	140	6.5	5.0	15.6	23.2	3.5	37
600114	7/16"	150	6.9	5.4	16.9	25.3	3.7	50
600116	1/2"	170	7.8	5.9	19.7	29.4	4.1	69
600118	9/16"	180	8.3	6.2	21.2	31.5	4.4	80
600120	5/8"	200	8.9	6.7	24.0	34.7	4.8	107
600122	11/16"	210	9.3	6.9	25.3	36.5	5.0	127
600124	3/4"	230	10.5	7.4	28.1	40.7	5.4	157
600126	13/16"	250	11.3	8.0	31.3	44.8	5.7	212
600128	7/8"	260	11.5	8.2	32.6	46.9	5.8	204
600130	15/16"	280	12.1	8.7	35.5	50.4	6.0	264
600132	1"	290	12.5	8.9	36.9	52.0	6.2	310
600134	1 1/8"	310	13.1	9.4	39.6	55.7	6.6	400
600136	1 1/4"	330	13.3	9.7	40.9	57.6	6.8	415
600140	1 1/2"	360	14.3	10.4	46.4	65.8	7.3	540
600142	1 3/8"	380	15.0	10.7	48.8	69.2	7.5	649
600144	1 1/2"	410	19.2	13.5	53.0	74.0	8.0	858
600146	1 7/8"	410	19.2	13.5	53.0	74.0	8.0	838
600148	1 1/2"	430	20.4	15.0	56.0	77.0	9.0	1002
600152	1 3/4"	460	21.6	16.0	61.0	84.0	10.0	1309
600156	1 3/2"	500	23.0	17.0	66.0	92.0	11.0	1595
600160	1 3/4"	540	24.6	18.0	73.0	102.0	12.0	2097

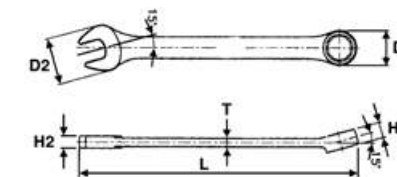

AF Combination Spanners →

TT6508R Ratcheting combination spanner set

8 piece ratcheting combination spanner set. Combined ring/open ended spanners with 12 point ring. Ratchet with flip reverse and offset by 13° for use on flat surfaces. Same size at both ends. Chrome vanadium. Satin finish. Supplied in the unique Teng Tools TC tray with removable lid and dove tail joints for use on it's own or as part of the Teng Tools TC control system. (265x142x50mm, 1.0 kilos)

Ratchet spanners 8, 10, 11, 12, 13, 14, 17, 19mm



TT6511R Ratcheting combination spanner set

11 piece ratcheting combination spanner set. Combined ring/open ended spanners with 12 point ring. Ratchet with flip reverse and offset by 13° for use on flat surfaces. Same size at both ends. Chrome vanadium. Satin finish. Supplied in the unique Teng Tools TC tray with removable lid and dove tail joints for use on it's own or as part of the Teng Tools TC control system. (265x142x50mm, 1.34 kilos)

Ratchet spanners 8, 10, 11, 12, 13, 14, 15, 16, 17, 18, 19mm



TED6512R Ratcheting Combination Spanner Set

12 piece set of metric ratcheting combination spanners with flip reverse. Supplied in the unique Teng Tools double width TC tray with removable lid and dove tail joints for use on it's own or as part of the Teng Tools TC control system. The tools are held in place using the Teng Tools three colour pre-cut EVA foam tool control system. (265x284x50mm, 1.83 kilos)

Ratcheting combination spanners 8, 9, 10, 11, 12, 13, 14, 15, 16, 17, 18, 19mm



DO'S AND DONT'S OF SPANNERS

- ✔ **The right size spanner**
Use the correct size spanner, the wrong size spanner will damage the fastening making it more difficult to tighten or loosen. It might also damage the spanner.
- ✔ **The right type of spanner**
Use the spanner type that gives you the best access, the most secure hold on the fastening and best turns the fastening (e.g. ratcheting spanners are very good for turning quickly but fixed spanners can give much more torque)
- ✘ **Keep it clean and dry**
After use always check the tools are clean and dry before putting them away, this will help to avoid problems such as corrosion and moving parts seizing or becoming tight.
- ✘ **Do not use scaffolding poles or similar**
If the fastening will not turn with the tools you are using you need to use a more powerful tool such as a larger tool or even an impact power tool. Do not use bars to increase the leverage – it is dangerous and can break the tool.
- ✘ **Do not use a vehicle to turn the nut**
Do not fix a spanner or wrench on to a fastening and then drive the vehicle to force it to turn – needless to say it is dangerous and can break the tools.

6508RMM Ratcheting Spanner Set

8 piece ratcheting combination spanner set. Combined ring/open ended spanners with 12 point ring. Ratchet with flip reverse and offset by 13° for use on flat surfaces. Same size at both ends. Chrome vanadium. Satin finish.

Ratchet spanners 8, 10, 11, 12, 13, 14, 17, 19mm



6510RMM Ratcheting Spanner Set

10 piece ratcheting combination spanner set. Combined ring/open ended spanners with a 12 point ring. Ratchet with flip reverse and offset by 13° for use on flat surfaces. Same size at both ends. Chrome vanadium. Satin finish. Supplied in a handy storage wallet.

Ratchet spanners 10, 11, 12, 13, 14, 15, 16, 17, 18, 19mm



Ratcheting Metric Combination Spanner Range

Ratcheting Combination Spanners. Combined ring/open ended spanner with 72 teeth and 12 point ring ratchet with flip reverse. Same size at both ends. The 12 point ratcheting ring end is offset at a 13° angle. Chrome vanadium. Satin Finish. DIN3113A.

Stock no.	Size mm	L mm	H1 mm	H2 mm	D1 mm	D2 mm	T mm	Weight g
600508R	8	140	6.5	4.0	17.0	17.0	2.8	30
600509R	9	150	6.9	4.4	18.5	19.0	2.7	30
600510R	10	159	7.3	4.8	20.0	21.0	3.3	50
600511R	11	165	7.7	5.2	22.0	23.0	3.6	70
600512R	12	172	8.2	5.5	23.0	25.0	3.9	80
600513R	13	178	8.5	5.8	25.0	27.0	4.0	100
600514R	14	191	9.0	6.2	27.0	29.0	4.3	120
600515R	15	200	9.4	6.5	28.0	31.0	4.5	140
600516R	16	208	9.9	6.8	30.0	33.0	4.7	170
600517R	17	226	10.3	7.2	32.0	36.0	5.0	200
600518R	18	237	10.7	7.7	33.0	38.0	5.2	210
600519R	19	248	11.2	8.2	34.0	40.0	5.5	220
600522R	22	290	13.0	9.0	38.4	45.0	6.0	360
600524R	24	323	14.5	9.8	43.6	52.0	6.5	510
600527R	27	359	15.5	10.5	52.5	56.0	7.7	640
600530R	30	403	17.0	11.4	58.5	59.0	8.2	880
600532R	32	425	17.5	12.5	62.5	63.0	8.7	1080

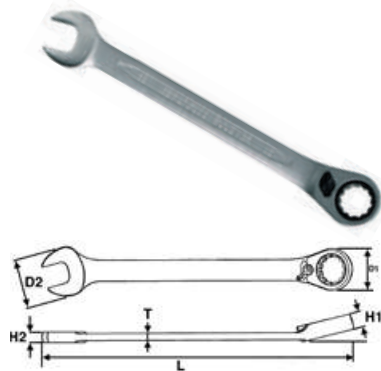

Ratcheting Metric Combination Spanner Range →

TT6508RS Ratcheting combination spanner set

8 piece ratcheting combination spanner set. Combined ring/open ended spanners with 12 point ring. 72 teeth ratchet action for rapid tightening and loosening. Same size at both ends. Chrome vanadium. Satin finish. Supplied in the unique Teng Tools TC tray with removable lid and dove tail joints for use on it's own or as part of the Teng Tools TC control system. (265x142x50mm, 1.14 kilos)

Ratchet spanners 8, 10, 11, 12, 13, 14, 17, 19mm



TT6511RS Ratcheting combination spanner set

11 piece ratcheting combination spanner set. Combined ring/open ended spanners with 12 point ring. 72 teeth ratchet action for rapid tightening and loosening. Same size at both ends. Chrome vanadium. Satin finish. Supplied in the unique Teng Tools TC tray with removable lid and dove tail joints for use on it's own or as part of the Teng Tools TC control system. (265x142x50mm, 1.34 kilos)

Ratchet spanners 8, 10, 11, 12, 13, 14, 15, 16, 17, 18, 19mm



TED6512RS Ratcheting Combination Spanner Set

12 piece set of metric ratcheting combination spanners. Supplied in the unique Teng Tools double width TC tray with removable lid and dove tail joints for use on it's own or as part of the Teng Tools TC control system. The tools are held in place using the Teng Tools three colour pre-cut EVA foam tool control system. (265x284x50mm, 1.91 kilos)

Ratcheting combination spanners 8, 9, 10, 11, 12, 13, 14, 15, 16, 17, 18, 19mm



WRSP12RS Ratcheting Combination Spanner Set

12 piece ratcheting combination spanner set. Satin finish. Chrome vanadium. Complete with a wall rack for fixing to the wall or a work bench.

Combination spanners 8, 9, 10, 11, 12, 13, 14, 15, 16, 17, 18, 19mm



6508RSMM Ratcheting spanner set

8 piece ratcheting combination spanner set. Combined ring/open ended spanners with 12 point ring. 72 teeth ratchet action for rapid tightening and loosening. Same size at both ends. Chrome vanadium. Satin finish.

Ratchet spanners 8, 10, 11, 12, 13, 14, 17, 19mm

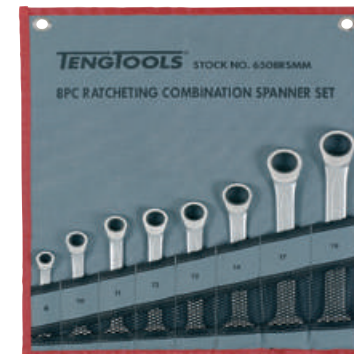

65RS12 Ratcheting Combination Spanner Set NEW!

- 12 piece ratcheting combination spanner set.
- Combined ring/open ended spanners
- 72 teeth with 12 point ratcheting ring end
- Chrome vanadium
- Supplied in plastic tray

Ratchet spanners 8, 9, 10, 11, 12, 13, 14, 15, 16, 17, 18, 19mm



6512RSMM Ratcheting Spanner Set

1 2 piece ratcheting combination spanner set. Combined ring/open ended spanners with 12 point ring. 72 teeth ratchet action for rapid tightening and loosening. Same size at both ends. Chrome vanadium. Satin finish.

Ratchet spanners 8, 9, 10, 11, 12, 13, 14, 15, 16, 17, 18, 19mm



Ratcheting Combination Spanner Range

Ratcheting combination spanners. Combined ring/open ended spanner with 72 teeth and 12 point ring ratchet. Same size at both ends. DIN899.

Stock No.	Size mm	L mm	A mm	B mm	C mm	D mm	H mm	T mm	Weight g
600508RS	8	111.0	19.6	17.0	4.0	6.8	8.0	2.8	30
600509RS	9	123.0	20.8	19.0	4.4	7.2	9.0	2.9	41
600510RS	10	131.0	22.0	20.0	4.8	7.6	9.5	3.3	48
600511RS	11	147.0	24.2	21.0	5.2	8.0	10.0	3.6	62
600512RS	12	155.0	25.7	23.0	5.5	8.5	11.0	3.9	78
600513RS	13	164.0	27.2	25.0	5.8	8.9	12.0	4.0	88
600514RS	14	182.0	30.8	27.0	6.2	9.3	13.0	4.3	112
600515RS	15	192.0	32.4	28.0	6.5	9.7	13.6	4.5	123
600516RS	16	202.0	34.0	30.0	6.8	10.2	14.4	4.7	144
600517RS	17	223.0	37.7	32.0	7.2	10.6	15.3	5.0	192
600518RS	18	234.0	39.3	33.0	7.7	11.0	16.2	5.2	207
600519RS	19	246.0	40.8	34.0	8.2	11.5	17.0	5.5	233
600520RS	20	285.0	46.0	42.0	10.0	13.0	18.8	6.4	385
600521RS	21	285.0	46.0	42.0	10.0	13.0	18.8	6.4	385
600522RS	22	285.0	46.0	42.0	10.0	13.0	18.8	6.4	387
600524RS	24	325.0	51.5	47.5	11.0	14.5	20.6	7.0	511



Ratchetting Combination Spanner Range →

TT6508RAF AF Ratcheting spanner set

8 piece ratcheting AF combination spanner set. Combined ring/open ended spanners with 12 point ring ratchet with flip reverse and offset at 13° for use on flat surfaces. Same size at both ends. Chrome vanadium. Satin finish. Supplied in the unique Teng Tools TC tray with removable lid and dove tail joints for use on it's own or as part of the Teng Tools TC control system. (265x142x50mm, 1.18 kilos)

Ratchet spanners 5/16" 3/8" 7/16" 1/2" 9/16" 5/8" 11/16" 3/4"



Ratcheting AF Combination Spanner Range

AF Ratcheting Combination Spanners. Combined ring/open ended spanner with 72 teeth and 12 point ring ratchet with flip reverse. Same size at both ends, offset at a 13° angle Chrome vanadium. Satin Finish. DIN3113A.

Stock no.	Size	L mm	H1 mm	H2 mm	D1 mm	D2 mm	T mm	Weight g
600110R	5/16"	140	6.5	4.6	16.6	16.7	3.0	30
600112R	3/8"	159	7.3	5.3	20.0	20.8	3.4	50
600114R	7/16"	165	7.7	5.6	21.8	23.0	3.7	70
600116R	1/2"	178	8.6	6.4	24.7	27.1	4.1	100
600118R	9/16"	191	9.0	6.8	27.0	29.2	4.4	120
600120R	5/8"	208	9.9	7.2	30.0	33.4	4.7	170
600122R	11/16"	226	10.3	7.7	31.8	35.5	5.1	200
600124R	3/4"	248	11.2	8.8	33.8	39.7	5.6	320
600126R	13/16"	290	13.0	9.0	40.0	46.0	6.0	360
600128R	7/8"	290	13.0	9.0	40.0	46.0	6.0	510

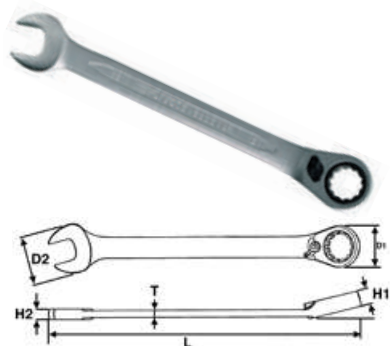

Ratcheting AF Combination Spanner Range →

TT6508RF Ratcheting combination spanner set

8 piece flexible ratcheting spanner set. Combined ring/open ended spanner and 12 point ring ratchet with 180° flexible joint. Same size at both ends, open end offset at a 13° angle. Chrome vanadium. Supplied in the unique Teng Tools TC tray with removable lid and dove tail joints for use on it's own or as part of the Teng Tools TC control system. Satin finish. (265x142x50mm, 1.1 kilos)

Ratchet spanners 8, 10, 11, 12, 13, 14, 17, 19mm



Flexible Ratchet Spanner Range

Flexible ratcheting wrenches. Combined ring/open ended spanner and 12 point ring ratchet with 180° flexible joint. Same dimensions at both ends. Chrome vanadium. Satin finish.

Stock no.	Size mm	L mm	H1 mm	H2 mm	D1 mm	D2 mm	T mm	Weight g
600507RF	7	127	6.8	4.0	17	17.6	2.8	50
600508RF	8	127	6.8	4.0	17	17.6	2.8	50
600509RF	9	131	7.2	4.4	19	19.8	2.9	50
600510RF	10	136	7.6	4.8	20	22.0	3.3	60
600511RF	11	141	8.0	5.2	21	24.1	3.6	60
600512RF	12	147	8.5	5.5	23	25.9	3.9	80
600513RF	13	154	9.0	5.8	25	27.3	4.0	100
600514RF	14	160	9.3	6.2	27	30.6	4.3	120
600515RF	15	169	9.7	6.5	28	32.2	4.3	120
600516RF	16	179	10.2	6.8	30	33.7	4.7	160
600517RF	17	190	10.6	7.2	32	36.6	5.0	190
600518RF	18	203	11.0	7.7	33	38.4	5.2	190
600519RF	19	215	11.5	8.2	34	40.2	5.5	200

Flexible Ratcheting Spanners →

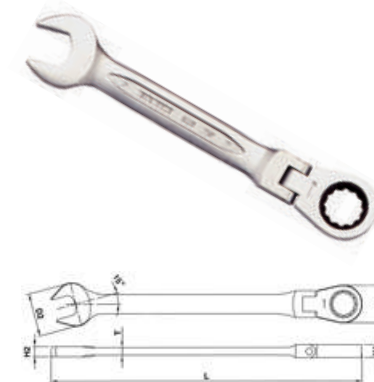

TT6010M Stubby spanner set

Set of 10 stubby spanners made of chrome vanadium steel. Same dimension at both ends. The 12 point ring head is set at a 15° angle. Satin finish. Supplied in the unique Teng Tools TC tray with removable lid and dove tail joints for use on it's own or as part of the Teng Tools TC control system. (265x142x50mm, 1.0 kilos)

Midget combination spanners 10, 11, 12, 13, 14, 15, 16, 17, 18, 19mm



Midget Combination Spanners

Midget combination spanners The 12 point ring head is set at a 15° angle. Chrome vanadium. Satin Finish. Same dimension at both ends. DIN3113A.

Stock no.	Size mm	L mm	H1 mm	H2 mm	D1 mm	D2 mm	T mm	Weight g
6005M10	10	95	7.0	5.1	16.2	21.9	3.4	30
6005M11	11	100	7.8	5.9	17.9	23.8	4.0	42
6005M12	12	105	8.2	6.6	19.1	24.7	4.2	48
6005M13	13	110	8.8	6.7	19.3	27.1	5.0	55
6005M14	14	115	9.1	7.4	21.8	28.9	5.1	66
6005M15	15	120	9.2	7.5	22.6	31.1	5.1	71
6005M16	16	125	9.8	8.1	23.6	33.0	5.6	87
6005M17	17	130	10.3	8.3	25.9	36.0	5.6	105
6005M18	18	135	11.0	8.7	27.2	36.8	5.8	118
6005M19	19	140	11.2	9.4	28.7	38.1	6.0	130

Midget Combination Spanners →

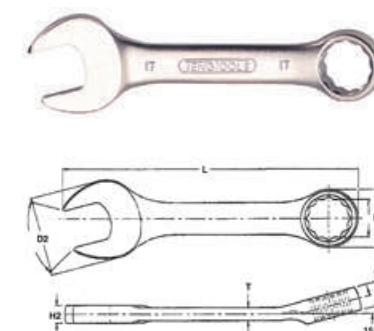



6059LMP Long Combination Spanner Set

Set of 9 long metric combination spanners. Chrome vanadium steel. Same dimensions at both ends. The 12 point ring head is angled at a 15° angle. Satin finish. Supplied in a handy tool roll.

Wrenches 8, 10, 11, 12, 13, 14, 15, 17, 19mm combination spanners

TTXLMP12 Extra Long Combination Spanner Set

12 piece extra long combination spanner set ranging from 8 to 19mm. Chrome vanadium, satin finish. Supplied in the unique Teng Tools drawer width TTX tray for use on it's own or as part of the Teng Tools TC control system. (570x115x70mm, 6.5 kilos)

Combination spanners 8, 9, 10, 11, 12, 13, 14, 15, 16, 17, 18, 19mm



WRSP12LMP Long Combination Spanner Set

12 piece extra long metric combination spanner set. Satin finish. Chrome vanadium. Complete with a wall rack for fixing to the wall or a work bench.

Combination spanners 8, 9, 10, 11, 12, 13, 14, 15, 16, 17, 18, 19mm



Long Combination Spanner Range

Long series metric Combination Spanners. Same dimension at both ends. The 12 point ring head is set at a 15° angle. Chrome vanadium. Satin finish. DIN3113A.

Stock no.	Size	L	H1	H2	D1	D2	T	Weight
mm	mm	mm	mm	mm	mm	mm	mm	g
605908	8	148	5.3	4.9	12.6	17.2	3.6	33
605909	9	158	6.2	5.0	13.7	19.4	3.8	40
605910	10	168	6.4	5.6	15.2	21.7	3.9	50
605911	11	188	7.3	5.6	16.7	23.1	4.2	62
605912	12	198	7.9	6.3	17.7	25.3	4.2	77
605913	13	208	8.6	6.7	19.8	26.6	4.5	87
605914	14	228	9.0	7.4	21.4	29.8	5.0	117
605915	15	238	9.9	7.6	22.5	32.4	5.0	142
605916	16	246	10.4	8.2	23.5	32.4	5.2	153
605917	17	266	10.5	8.2	25.4	36.0	5.8	174
605918	18	276	12.4	9.0	26.6	37.4	5.8	215
605919	19	285	12.6	9.1	28.3	39.8	6.1	220

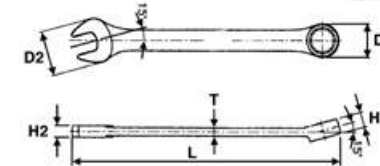

Long Combination Spanner Range →

601013 Compact Double Ring Spanner

The "Rigger Jigger". Angled, compact, special ring spanner with 12 point opening. The ideal compact ring spanner for the most popular fastening sizes (10/13mm). Total length 120mm. Ideal to keep in a pocket. DIN3113A.



6308 Double Ring Spanner Set

An 8 piece metric double ring spanner set from 6x7mm to 20x22mm with different bi-hexagonal openings at each end, all the heads are offset by 75°. Supplied in a coloured display box only.

Double ring spanners 6x7, 8x9, 10x11, 12x13, 14x15, 16x17, 18x19, 20x22mm



6311 Double Ring Spanner Set

An 11 piece metric double ring spanner set from 6x7mm to 20x22mm with different bi-hexagonal openings at each end, all the heads are offset by 75°. Supplied in a coloured display box only.

Double ring spanners 6x7, 8x9, 10x11, 12x13, 14x15, 16x17, 18x19, 20x22, 21x23, 24x27, 30x32mm

6308MM Double Ring Spanner Set

An 8 piece metric double ring spanner set from 6x7mm to 20x22mm with different bi-hexagonal openings at each end, all the heads are offset by 75°, comes complete in a handy tool roll. Satin finish. DIN 838.

Double ring spanners 6x7mm, 8x9mm, 10x11mm, 12x13mm, 14x15mm, 16x17mm, 18x19mm, 20x22mm



TTX6311 Double ring spanner set

11 piece double ring spanner set ranging from 6x7mm to 30x32mm. Chrome vanadium steel. DIN 838/ISO 3318. Satin finish. Supplied in the unique Teng Tools TTX tray for use on it's own or as part of the Teng Tools TC control system. (570x115x60mm, 2.9 kilos)

Double ring spanners 6 x 7mm, 8 x 9mm, 10 x 11mm, 12 x 13mm, 14 x 15mm, 16 x 17mm, 18 x 19mm, 20 x 22mm, 21 x 23mm, 24 x 27mm, 30 x 32mm



TEX6308 Double Ring Spanner Set **NEW!**

8 piece double ring spanner set supplied in the unique Teng Tools drawer width TTX tray for use on it's own or as part of the Teng Tools TC control system. The tools are held in place using the Teng Tools three colour pre-cut EVA foam tool control system (570x115x60mm, 1.2 kilos)



Double ring spanners	6x7, 8x9, 10x11, 12x13, 14x15, 16x17, 18x19, 20x22mm
----------------------	--

Double Ring Spanner Range

Double Ring spanners. With different size bi-hexagonal openings at each end. Double curved 75° - high angle. Metric, DIN 838. Chrome vanadium. Satin Finish. DIN3113A.

Stock no.	Size	L	H1	H2	D1	D2	T	Weight
mm	mm	mm	mm	mm	mm	mm	mm	g
630607	6x7	168	5.6	6.3	10.7	12.2	4.1	45
630809	8x9	183	6.6	7.0	13.6	15.1	4.5	60
631011	10x11	198	7.4	7.7	16.6	18.0	4.9	100
631213	12x13	217	8.1	8.4	19.5	20.9	5.4	105
631415	14x15	239	8.8	9.1	22.4	23.7	5.7	145
631617	16x17	260	9.5	9.8	25.3	26.7	6.2	195
631819	18x19	292	10.1	10.4	28.2	29.7	6.6	250
632022	20x22	318	10.9	11.4	31.1	34.0	7.1	320
632123	21x23	326.5	11.2	11.6	32.6	35.5	7.6	340
632427	24x27	329	12.4	13.4	36.9	41.0	8.1	475
633032	30x32	362	14.4	15.2	45.5	48.5	9.0	522

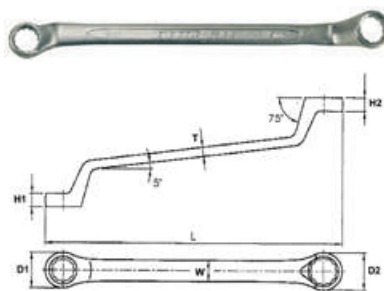

Double Ring Spanner Range →

TTXFLS06 Extra Long Double Ring Spanner Set

6 piece extra long double ring spanner set ranging from 8x10mm to 22x24mm. 12 point rings at each end. Chrome vanadium. Supplied in the unique Teng Tools drawer width TTX tray for use on it's own or as part of the Teng Tools TC control system. (570x115x70mm, 6.5 kilos)



Double ring spanners	8x10, 11x13, 12x14, 16x18, 17x19, 22x24mm
----------------------	---

TEXFLS06 Extra Long Double Ring Spanner Set **NEW!**

6 piece extra long double ring spanner set supplied in the unique Teng Tools drawer width TTX tray for use on it's own or as part of the Teng Tools TC control system. The tools are held in place using the Teng Tools three colour pre-cut EVA foam tool control system. (570x115x70mm, 1.2 kilos)



Double ring spanners	8x10, 11x13, 12x14, 16x18, 17x19, 22x24mm
----------------------	---

WRFLS05 Extra long double ring spanner Set

5 piece extra long double ring spanner set covering 8 to 24mm with different bi-hexagonal sizes at each end. Satin finish. Chrome vanadium. Complete with a wall rack for fixing to the wall or a work bench.



Double ring spanners	8x10, 11x13, 12x14, 17x19, 22x24mm
----------------------	------------------------------------

Long Double Ring Spanners

Flat double ring spanners, with different size bi-hexagonal openings at each end. Metric. Satin finish.

Stock No.	Size	L	A	B	C	D	Weight
mm	mm	mm	mm	mm	mm	mm	g
630810FL	8x10	265	12.5	15.0	7.5	8.4	72
631113FL	11x13	328	17.8	20.3	10.4	11.3	155
631214FL	12x14	328	17.8	20.3	10.4	11.3	157
631618FL	16x18	408	23.4	26.3	12.8	14.4	284
631719FL	17x19	407	23.7	26.6	13.0	14.8	284
632224FL	22x24	430	31.3	34.0	15.4	17.7	482

Long Double Ring Spanner Range →

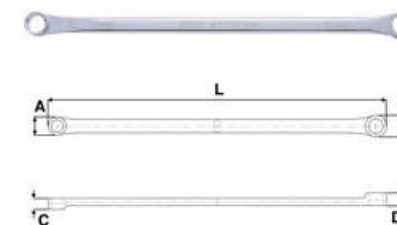

600 Spanner Ring

The Teng Tools spanner ring is ideal for storing combination and double ring spanners.



6208 Double Open Ended Spanner Set

An 8 piece metric double open ended spanner set from 6x7mm to 20x22mm with different openings at each end. DIN3110 ISO3318. Supplied in a coloured display box only.

Double open ended spanners	6x7, 8x9, 10x11, 12x13, 14x15, 16x17, 18x19, 20x22mm
----------------------------	--





TT6208 Double open ended spanner set

Set of 8 double open ended spanners. Chrome vanadium steel. Polished heads. DIN3110. Supplied in the unique Teng Tools TC tray with removable lid and dove tail joints for use on it's own or as part of the Teng Tools TC control system. (265x142x50mm, 0.8 kilos) (265x142x50mm, 0.8 kilos)

Double open ended spanners	6x7mm, 8x9mm, 10x11mm, 12x13mm, 14x15mm, 16x17mm, 18x19mm, 20x22mm
----------------------------	--



6211MM Double Open Spanner Set

11 piece double open ended spanner set with the different dimensions at each end. DIN 3110 ISO3318. Polished heads with satin finish. Supplied in a handy tool roll.

Double open ended	6x7mm, 8x9mm, 10x11mm, 12x13mm, 14x15mm, 16x17mm, 18x19mm, 20x22mm, 21x23mm, 24x27mm, 30x32mm
-------------------	---



6211 11 Piece Double open ended spanner set

11 piece metric double open ended spanner set with the different dimension at each end. DIN3110 ISO3318. Polished heads with satin finish. Supplied in a coloured display box only.

Double open ended	6x7mm, 8x9mm, 10x11mm, 12x13mm, 14x15mm, 16x17mm, 18x19mm, 20x22mm, 21x23mm, 24x27mm, 30x32mm
-------------------	---

Double Open Ended Spanners Range

Double Open Ended Spanners, Metric, DIN 3110, Offset 15°. Different dimensions at each end. Chrome vanadium. Satin Finish. DIN3113A.

Stock no.	Size	L	H	D1	D2	T	Weight
	mm	mm	mm	mm	mm	mm	g
620607	6x7	123	3.7	18.0	15.5	3.7	25
620809	8x9	140	4.0	22.7	20.4	4.0	35
621011	10x11	156	5.0	27.1	24.9	5.0	50
621213	12x13	172	5.5	31.2	29.2	5.5	75
621415	14x15	188.5	5.9	35.3	33.3	5.9	105
621617	16x17	204	6.3	38.9	37.1	6.3	155
621819	18x19	221	6.7	42.8	40.9	6.7	190
622022	20x22	237	7.1	48.8	44.8	7.1	220
622123	21x23	247	7.7	50.8	46.8	7.7	245
622427	24x27	263	8.1	59.1	52.8	8.1	305
623032	30x32	298	9.0	69.8	65.4	9.0	465

Double Open Ended Spanners Range →

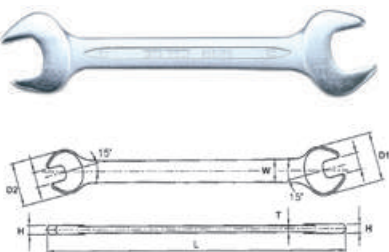

EVERY SECOND COUNTS

POLE POSITION ACCORDING TO TENG



Get organised™



WRENCHES

Double ring spanners

- Double offset ring heads with a 75 degree angle gives excellent access.
- The best-selling "Rigger Jigger" combines 10 mm and 13 mm ring heads on a pocket-sized short spanner, ideal for the most common sizes of nuts and bolts.



Swivel head wrenches

- Twelve-point swivel head wrenches with one size at each end and 180 degree flexible pivot to gain access to even the most hard to reach nuts and bolts.
- Designed with thicker handles for a more comfortable grip.
- Ideal for quick tightening or loosening.
- Hole in the handle for tool securing or hanging.
- The range includes "Bi-Flex" wrenches with a 1/4" square drive for use with sockets and a 1/4" hexagonal drive for use with bits.



Socket drivers

- Made in TTMV steel for extra strength and hardness.
- Hex opening for safe use with nuts and bolts.
- Ergonomically designed bi-material handles with hole for tool-securing when working at height or for hanging.



Open Ended Slogging Wrenches

Open ended impact slogging wrenches. DIN3126. Chrome Molybdenum.

Stock No	Size	L	A	B	C	D	L3	H	Weight
		mm	mm	mm	mm	mm	mm	mm	g
902024	24	178	52.3	14.5	23.4	7.8	107.5	10.2	250
902027	27	180	55.0	15.5	25.2	8.6	107.5	10.2	350
902030	30	190	60.4	16.2	30.0	9.5	107.5	15.6	500
902032	32	190	60.5	16.7	30.5	9.8	108.0	14.8	480
902036	36	214	71.3	17.0	35.0	9.8	118.0	14.9	700
902038	38	215	72.0	17.3	37.0	9.8	118.0	16.2	750
902041	41	233	82.4	19.2	39.3	12.0	127.6	18.3	900
902046	46	252	93.2	20.4	44.2	12.8	135.6	18.8	1300
902050	50	275	104.0	21.3	48.0	13.2	140.8	19.6	1500
902055	55	295	114.4	23.8	54.2	15.3	158.6	24.2	1950
902060	60	315	125.1	26.6	58.8	17.3	166.2	24.8	2500
902065	65	340	138.0	28.8	55.0	17.6	175.0	25.1	3300
902070	70	370	152.7	30.6	69.0	19.0	190.0	32.0	4300
902075	75	370	152.7	31.0	69.0	19.0	190.0	33.4	4700
902080	80	397	175.0	33.2	71.5	19.0	180.0	46.6	5500
902085	85	397	175.0	33.2	71.5	19.0	180.0	46.6	5200
902090	90	444	191.0	34.7	80.0	19.6	190.0	51.7	7000
902095	95	444	191.3	36.3	80.0	21.0	190.0	52.2	6600
902100	100	488	225.0	42.3	85.0	21.8	205.0	55.5	10500

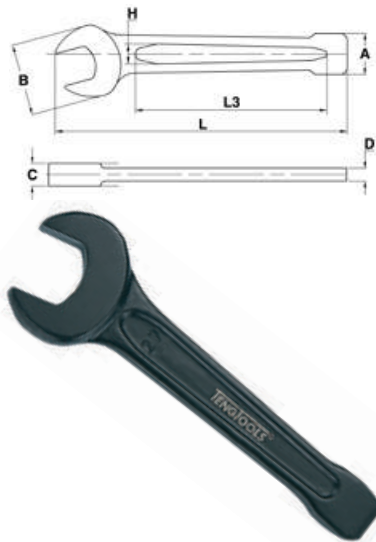

Open Ended Slogging Wrenches →

Ring Type Slogging Wrenches

Ring type impact slogging wrenches. DIN3126. Chrome Molybdenum.

Stock No	Size	L	A	B	C	D	L3	H	Weight
		mm	mm	mm	mm	mm	mm	mm	g
903024	24	162	42.8	14.7	24.6	7.9	93.9	9.4	248
903027	27	180	45.2	15.4	25.0	8.6	107.3	9.4	260
903030	30	190	50.6	16.2	29.4	9.3	107.3	11.5	376
903032	32	190	53.7	16.4	31.7	10.0	107.3	12.3	480
903036	36	205	58.3	17.9	35.6	10.5	107.3	13.3	520
903038	38	229	63.7	19.9	36.9	12.0	130.3	13.3	660
903041	41	230	63.9	19.9	37.4	12.3	130.3	13.3	780
903046	46	240	73.5	21.8	43.9	12.5	130.9	14.5	1150
903050	50	255	78.5	23.2	46.3	13.0	134.5	17.0	1070
903055	55	266	85.1	25.0	49.4	15.5	141.2	19.3	1350
903060	60	280	91.7	26.5	52.2	16.5	150.0	22.7	1650
903065	65	298	100.0	27.5	54.0	16.5	150.0	23.2	1890
903070	70	330	109.5	32.8	62.0	20.0	165.0	24.6	2850
903075	75	330	110.0	32.8	62.2	20.0	154.0	24.6	2700
903080	80	355	129.4	37.0	82.3	23.8	170.0	40.0	3400
903085	85	355	129.5	37.3	82.0	23.4	170.0	40.0	4100
903090	90	395	143.5	40.0	72.7	24.2	170.0	47.5	5200
903095	95	390	144.0	37.1	72.8	20.8	165.0	47.5	5100
903100	100	420	155.0	41.6	80.0	23.6	175.0	50.0	6700

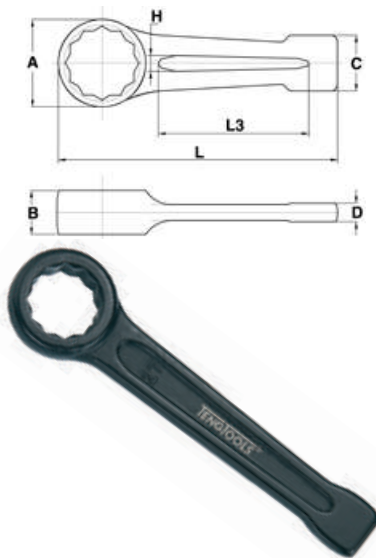

Ring Type Slogging Wrenches →

TT6506 Double flex wrench set

6 piece double flex wrench set, with different size 12 point sockets at each end. Satin finish. Chrome vanadium. Supplied in the unique Teng Tools TC tray with removable lid and dove tail joints for use on it's own or as part of the Teng Tools TC control system. (265x142x50mm, 1.57 kilos)

Double flex wrenches	8x9mm, 10x11mm, 12x13mm, 14x15mm, 16x17mm, 18x19mm
----------------------	--



WRDF06 Double Flex Wrench Set

6 piece double flex wrench set, with different size swivelling 12 point sockets at each end. Satin finish. Chrome vanadium. Complete with a wall rack for fixing to the wall or a work bench.

Double flex wrenches	8x9, 10x11, 12x13, 14x15, 16x17, 18x19mm
----------------------	--

Double flex wrenches

Double flex wrenches, with different sizes 12 point sockets at each end. Chrome vanadium. Satin finish. DIN3113A.

Stock No.	Size	L	D1	D2	W	T	Weight
	mm	mm	mm	mm	mm	mm	g
650809	8x9	192	12.2	13.5	10.0	4.6	95
651011	10x11	200	15.5	16.9	10.0	4.6	105
651013	10x13	213	14.5	18.2	12.5	5.0	140
651213	12x13	218	18.2	19.2	12.5	5.0	150
651415	14x15	243	20.5	21.7	14.0	5.8	215
651617	16x17	275	23.0	24.2	15.0	6.5	300
651819	18x19	284	25.5	26.7	16.0	7.5	382

Stock No.	Size	L	D1	D2	W	T	Weight
	mm	mm	mm	mm	mm	mm	g
611214	3/8"x7/16"	200	15.5	16.9	10.0	4.6	105
611618	1/2"x9/16"	218	18.2	19.2	12.5	5.0	150
612022	5/8"x11/16"	275	23.0	24.2	14.0	6.5	300

Double Flex Wrenches →

691406 Bi-Flex Wrench

Bi-Flex wrench with 1/4" bit socket at one end of the wrench (to suit most screwdriver bits) and with 1/4" drive at the other end (to suit 1/4" drive sockets). Chrome vanadium. Satin finish.

Size	L	D1	D2	W	T	Weight
	mm	mm	mm	mm	mm	g
1/4" hex x 1/4" M	196	14.5	14.5	10.0	4.6	102

Flare Nut Wrenches Range

Double Flare Nut Wrenches with different openings at each end. DIN3113A Chrome vanadium. Satin Finish.

Stock No.	Size	L	H	D1	D2	C1	C2	T	Weight
	mm	mm	mm	mm	mm	mm	mm	mm	g
641011	10x11	152.4	7.9	21.4	23.0	7.0	8.2	4.3	60
641213	12x13	178.6	10.0	25.0	27.4	9.0	10.3	5.7	113
641314	13x14	178.6	13.1	25.0	27.4	14.3	15.1	5.7	113
641617	16x17	196.0	15.1	29.9	31.9	15.4	17.0	6.4	113
641922	19x22	207.7	17.0	34.2	38.2	18.9	20.0	7.4	113

Stock No.	Size	L	H	D1	D2	C1	C2	T	Weight
	mm	mm	mm	mm	mm	mm	mm	mm	g
661416	7/16x1/2	158.8	11.9	23.0	24.3	8.2	9.0	5.5	113

Flare Nut Wrenches →

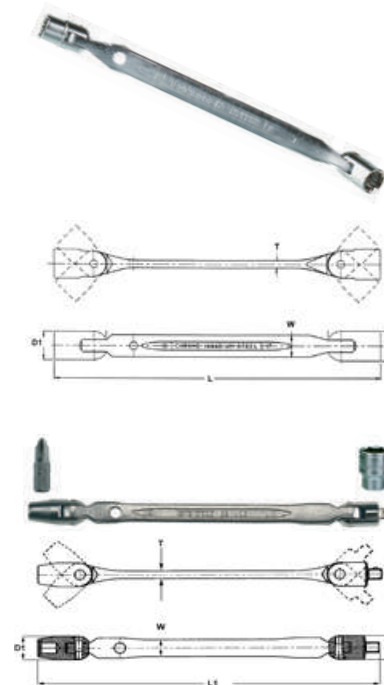

Door and Window Hinge Adjustment Wrenches

NEW!

Wrenches that are specifically designed for adjusting exterior door and window hinges. A range of sizes to suit different designs.

Stock No.	Length mm	Hole diameter mm	Weight g
DHW1300	220	13	170
DHW1417	290	14 x 17	310
DHW1922	300	19 x 22	440



TTRORS RORS wrench set

6 fibre reinforced chrome vanadium steel ratcheting offset ring spanners. Double ended with 25° 12 point heads (6x8mm 6 point). Reversible action. Satin finish. Supplied in the unique Teng Tools TC tray with removable lid and dove tail joints for use on it's own or as part of the Teng Tools TC control system. (265x142x50mm, 1.26 kilos)

RORS wrenches	6 x 8mm, 7 x 9mm, 10 x 13mm, 12 x 14mm, 17 x 19mm, 21 x 22mm
---------------	--



Ratcheting Offset Ring Spanners

Double Ratcheting Offset Ring Spanners (RORS), Offset 25 degrees. Chrome vanadium. Satin Finish.

Stock No.	Size mm	L mm	H mm	D1 mm	D2 mm	Weight g
680608	6x8	112	8.0	20.0	20.0	63
680709	7x9	133	8.4	21.0	23.0	81
681013	10x13	163	10.2	26.0	30.0	149
681214	12x14	172	10.2	30.0	32.0	169
681719	17x19	203	11.0	37.0	40.0	254
682122	21x22	235	11.4	41.0	45.0	290

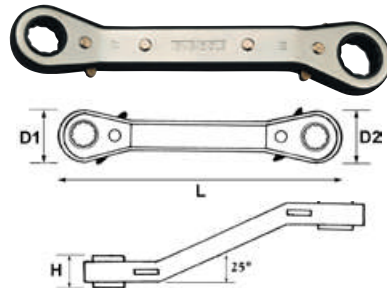

Ratcheting Offset Ring Spanners →

6503RX Multidrive Ratchet Ring Spanner Set

3 piece set of ratcheting ring spanners with two sizes at each end covering 12 sizes from 8mm to 19mm with just three spanners. 12 point with flip reverse at both ends. Satin finish. Supplied in a handy storage wallet.

Multidrive ring spanners	8x9 + 10x11, 12x13 + 14x15, 16x17+18x19
--------------------------	---



Multidrive Ratchet Ring Spanners

Ratcheting ring spanners with two sizes at each end. 12 point with flip reverse at both ends. Satin finish.

Stock no.	Sizes	L mm	D1 mm	D2 mm	Weight g
60050811RX	8x9 + 10x11	150	19.2	22.0	13.5
60051215RX	12x13 + 14x15	190	25.5	28.0	18.4
60051619RX	16x17+18x19	320	31.7	34.0	20.8

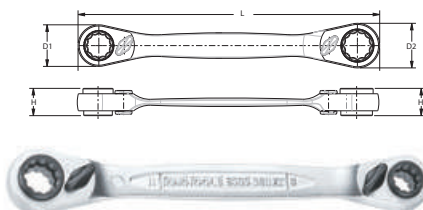

Multidrive Ratchet Ring Spanners →

Ratcheting Offset TX-E Spanners

Double offset ring spanner with different size sockets at each end, for TX-E heads. Angled 25° towards the handle. Reversible action. Chrome vanadium. Satin finish.

Stock no.	Size	L mm	H mm	D1 mm	D2 mm	Weight g
680607E	E6xE7	112	8.0	20.0	20.0	66
680810E	E8xE10	133	8.2	21.0	23.0	84
681112E	E11xE12	140	8.2	23.0	26.0	95
681416E	E14xE16	172	10.2	30.0	32.0	174
681820E	E18xE20	203	11.5	37.0	40.0	280
682224E	E22xE24	235	11.5	41.0	44.0	330

Ratcheting Offset TX-E Spanners →

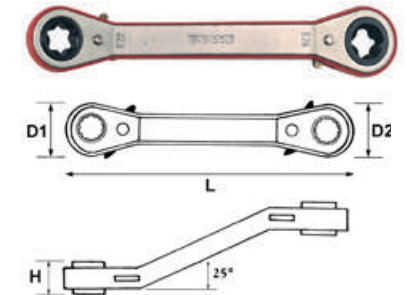

Teng Tools - The choice of champions including 2017 World Speedway Champion Jason Doyle.

Design

- Integral measurement scale on the jaws makes it easy to accurately measure the size of nuts.
- A wider jaw opening increases the bolt sizes that can be worked on.
- Bi-material handle gives extra comfort, especially when the adjustable wrench is used for long periods.
- Hole in the handle for tool-securing when working at height or for practical hanging.

Quality

- Exceeds specifications in the international standards: ISO6787-1982, ASME B.107.8M-1996, BS6333-1995, DIN3117-1988, JISB4604-1976, SABS1211-1984
- Made of high grade chrome vanadium steel with a phosphate surface.

Range

- Available from 4" (100 mm) to 24" (600 mm), which gives a tightening range on nuts from 0 to 70 mm.
- Adjustable wrenches with bi-material handles in 5 different sizes.
- A range of adjustable wrenches with bi-material handles and extra wide jaw opening.
- Now also an adjustable wrench with practical pipe grip at the end of the handle.

Where space is limited

- 15 degree jaw angle means that the adjustable wrench can be used in confined spaces where only 30 degree rotation is possible.
- Thin heads give better access.
- The moving jaw does not protrude from the body making it easier to work in hard to reach areas.



ADJUSTABLE WRENCHES

We proudly present Teng Tools adjustable wrenches. Here you will find an adjustable wrench for every need: the range includes the classic model in eight sizes with a capacity up to 70 mm, the ergonomic model with a comfortable handle in five sizes, the adjustable wrench with extra wide opening and one model with a pipe grip at the end. Our wrenches offer numerous smart benefits, such as integrated scale and non-protruding jaws.

Adjustable Wrenches with Graduated Scale

Industrial adjustable wrenches made of chrome vanadium. Exceeding international standards ISO 6787-1982, ASME B.107.8M-1996, BS 6333-1995, DIN 3117-1988, JIS B4604-1976. The 15° jaw allows the wrench to be used in narrow areas as only 30° turning is needed. The wider jaw opening increases the range of bolt sizes to be worked on. Non protruding on the movable jaw end gives better action when space is limited. The handle provides a comfortable hand fit. Phosphate finish.

Stock No.	L mm	L inch	Capacity mm	Capacity inch	T mm	D mm	ISO Norm	Weight g
4001	100	4	17	5/8"	14	31	33	50
4002	150	6	24	13/16"	19	44	85	140
4003	200	8	28	1 1/8"	26	57	180	260
4004	250	10	33	1 1/4"	31	68	320	440
4005	300	12	38	1 1/2"	32	80	515	660
4006	375	15	50	1 3/8"	44	100	920	1200
4007	450	18	60	2 1/4"	53	122	-	2000
4008	600	24	70	2 3/4"	62	144	-	3700

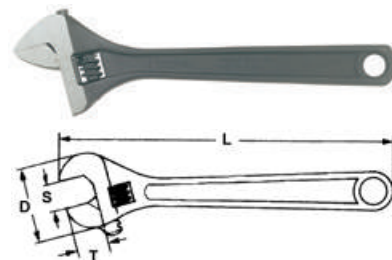

Adjustable Wrenches Range →

Service Kits

All Teng Tools adjustable wrenches should be cleaned and maintained on a regular basis to reduce wear and to prolong life. However, with all tools involving moving parts some wear will occur with time. Teng Tools offer a full range of complete service kits and spare parts for all their adjustable wrenches – full details available from your local Teng Tools stockist but the table below lists the service kits for the most commonly used adjustable wrenches. Each service kit includes a replacement screw, knurl and spring.

Stock no.	Suitable for
4001RK	4001 4" adjustable wrench
4002RK	4002 6" adjustable wrench
4003RK	4003 8" adjustable wrench
4004RK	4004 10" adjustable wrench
4005RK	4005 12" adjustable wrench
4006RK	4006 15" adjustable wrench
4007RK	4007 18" adjustable wrench
4008RK	4008 24" adjustable wrench

TTADJ04 Adjustable wrench set

Set containing 3 Teng Tools adjustable wrenches with bi-material grip handles and the 8" wide jaw opening adjustable wrench with vinyl grip. Supplied in the unique Teng Tools TC tray with removable lid and dove tail joints for use on it's own or as part of the Teng Tools TC control system. (265x142x50mm, 1.37 kilos)

Adjustable wrenches	6" (23.9mm capacity)
	8" (28.6mm capacity)
	10" (32.8mm capacity)
	8" wide jaw (38.6mm capacity)



TEDADJ4 Adjustable wrench Set

4 piece adjustable wrench set. Supplied in the unique Teng Tools double width TC tray with removable lid and dove tail joints for use on it's own or as part of the Teng Tools TC control system. The tools are held in place using the Teng Tools three colour pre-cut EVA foam tool control system. (265x284x50mm, 1.58 kilos)

Adjustable wrenches	6" (150mm), 8" (200mm), 10" (250mm)
	Wide jaw adjustable wrench 8" (200mm)



Adjustable wrenches with Bi-material grip and graduated scale

Industrial adjustable wrenches made of chrome vanadium. Exceeding international standards ISO6787-1982, ASME B.107.8M-1996, BS6333-1995, JISB4604-1976. The 15° jaw allows the wrench to be used in narrow areas as only 30° turning is needed. The wider jaw opening increases the range of bolt sizes that can be fitted. Non protruding on the moveable jaw end gives better access where space is limited. Phosphate finish with graduated scale and bi-material grip handle.

Stock No.	L mm	L inch	Capacity mm	Capacity inch	H mm	W mm	ISO Norm	Weight g
4002IQ	157	6	24	15/16"	20.0	52	85	140
4003IQ	206	8	28	1 1/8"	25.3	62	180	260
4004IQ	255	10	33	1 1/4"	29.5	72	320	440
4005IQ	305	12	38	1 1/2"	32.2	83	515	660
4006IQ	380	15	50	1 3/8"	44.7	108	920	1200



Adjustable Wrenches →



Service Kits

All Teng Tools adjustable wrenches should be cleaned and maintained on a regular basis to reduce wear and to prolong life. However, with all tools involving moving parts some wear will occur with time. Teng Tools offer a full range of complete service kits and spare parts for all their adjustable wrenches – full details available from your local Teng Tools stockist but the table below lists the service kits for the most commonly used adjustable wrenches. Each service kit includes a replacement screw, knurl and spring.

Stock No.	Suitable for
4002IQRK	4002IQ 6" adjustable wrench
4003IQRK	4003IQ 8" adjustable wrench
4004IQRK	4004IQ 10" adjustable wrench
4005IQRK	4005IQ 12" adjustable wrench
4006IQRK	4006IQ 15" adjustable wrench

Wide jaw opening adjustable wrenches

Adjustable wrenches with an extra wide jaw opening. Chrome vanadium steel, a 15° jaw angle, ergonomically designed bi-material handle grip and phosphate finish with a graduated scale on the jaws. Exceeding international standards ISO6787-1982, ASME B.107.8-1996, BS6333-1995, DIN3117-1988, JIS B4604-1976.

Stock No.	Length mm	Length inch	Capacity mm	Capacity AF	T mm	D mm	Weight g
4002WT	172	7	34.0	1 3/8"	30.0	63.5	185
4003WT	221	8	38.6	1 1/2"	34.1	72.1	260
4004WT	275	10	50	2"	41.0	92.1	440
4005WT	317	12	60	2 3/8"	55.7	110.5	660

Adjustable Wrenches →



Service Kits

All Teng Tools adjustable wrenches should be cleaned and maintained on a regular basis to reduce wear and to prolong life. However, with all tools involving moving parts some wear will occur with time. Teng Tools offer a full range of complete service kits and spare parts for all their adjustable wrenches – full details available from your local Teng Tools stockist but the table below lists the service kits for the most commonly used adjustable wrenches. Each service kit includes a replacement screw, knurl and spring.

Stock no.	Suitable for
4002WTRK	4002WT 6" wide jaw adjustable wrench
4003WTRK	4003WT 8" wide jaw adjustable wrench
4004WTRK	4004WT 10" wide jaw adjustable wrench
4005WTRK	4005WT 12" wide jaw adjustable wrench

TTXMB02 Water Pump Plier and Adjustable Wrench Set NEW!

Two really handy tools in one TTX tray for use on it's own or as part of the Teng Tools TC control system. The set includes the MB482-10Q Quick adjust 10" water pump plier and the 4003J 10" "Alligator" adjustable wrench with pipe grip. (570x115x40mm, 0.97 kilos).



Wrenches	10"	Alligator adjustable
Pliers	10"	Quick action water pump

TEXMB02 Water Pump Pliers & Alligator Adjustable Wrench Set NEW!

Two really handy tools in one TTX Tray for use on it's own or as part of the Teng Tools TC control system. The set includes the MB482-10Q quick adjustable water pump plier and the 4003J 10" "Alligator" adjustable wrench with pipe grip. The tools are held in place using the Teng Tools three colour pre-cut EVA foam tool control system. (570x115x40mm, 0.97 kilos)



Wrenches	10"	Alligator adjustable
Pliers	10"	Quick action water pipe

4003J "Alligator" Adjustable Wrench

A very handy 8" adjustable wrench with a practical pipe grip on one end with a capacity of M2 to M8 and a regular Teng Tools adjustable wrench jaw at the other with a jaw capacity of 32mm (1 3/8"). The jaw has a gauge and is set at a 15° angle for easier use. No part of the jaw movement protrudes making it ideal for use in confined areas. A hanging hole enables a safety hook to be fitted for fall arrest or for hanging on a work bench panel. Phosphate finish chrome vanadium.



Pipe Wrenches

Lightweight aluminium pipe wrenches in a sturdy design. One hand operation leaving the other hand free.

Stock No.	Capacity mm	Capacity inches	Overall length mm	Overall length inches	Weight g
PW12A	39	1 1/4"	300	12	710
PW14A	47	1 7/8"	350	14	950
PW18A	63	2 1/2"	450	18	1600
PW24A	76	3"	600	24	2450
PW36A	127	5"	900	36	4460



Pipe Wrenches →

BWT406 Basin tap Wrench

A basin tap wrench for reaching behind the sink or bath. A spring loaded, serrated jaw quickly grips on nuts and pipes, etc. between 32 and 48mm diameter. A telescopic handle for even easier access in difficult to reach places giving an overall length of between 275 and 400mm.



TTX3892 3/8" Torque Wrench set

22 piece set consisting of a 3/8" drive torque wrench, 10 crow foot wrenches, bit adaptor, 8 TX bits, 3" and 5" extension bars. Supplied in the unique Teng Tools TC tray for use on it's own or as part of the Teng Tools TC control system. (570x115x60mm, 0.9 kilos)



Torque wrench	3/8" drive	angular gauge torque wrench(20-100Nm, 15-75 ft/lb)
Accessories	3/8" drive	3" and 5" extensions, adaptor for 10mm hex bits
TX bits	10mm hex drive	TX8, TX10, TX15, TX20, TX25, TX27, TX30, TX40
Crow foot wrenches	3/8" drive	10, 11, 12, 13, 14, 15, 16, 17, 18, 19mm

M3808MM Crow foot wrench set

3/8" drive metric crow foot wrenches. Set of 8 spanners. Satin finish. Chrome vanadium steel. The spanners are supplied on a clip rail with 3/8" drive. For tightening with socket tools e.g. extension bar and ratchet handle.

Crow foot wrenches 10, 11, 12, 13, 16, 17, 18, 19 mm



Crow foot wrenches

Metric Crow Foot Wrenches for tightening with socket tools, e.g. extension bar and ratchet handle. Chrome vanadium. Satin Finish.

Stock no.	Drive	Size mm	L mm	H mm	D mm	Weight g
M386510-C	3/8"	10	32.3	4.8	21.3	36
M386511-C	3/8"	11	34.3	5.2	23.1	50
M386512-C	3/8"	12	36.2	5.6	25.5	58
M386513-C	3/8"	13	37.4	6.0	26.9	70
M386514-C	3/8"	14	40.0	6.2	30.2	86
M386515-C	3/8"	15	41.3	6.7	33.3	90
M386516-C	3/8"	16	41.3	6.7	33.3	114
M386517-C	3/8"	17	45.5	8.5	38.1	116
M386518-C	3/8"	18	45.5	8.5	38.1	140
M386519-C	3/8"	19	47.6	8.5	39.6	168

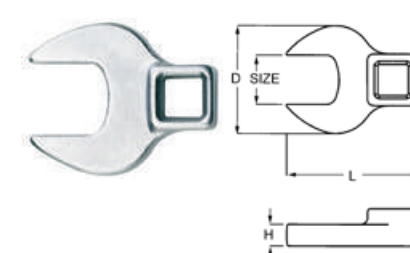

Crow Foot Wrenches →



TTXMDN Nut driver set

9 piece nut driver set with chrome vanadium steel blades, 6 point opening and ergonomically designed two component handles with hanging hole. Supplied in the unique Teng Tools TC tray for use on it's own or as part of the Teng Tools TC control system. (570x115x40mm, 1.6 kilos)



Nut drivers 5, 5.5, 6, 7, 8, 10, 11, 12, 13mm

TTEX23 Wrenches set

Set containing metric T handle nut drivers and metric hex and TX/TPX T handle drivers. Supplied in the Teng Tools three colour pre-cut EVA foam tool control system. (570x375x75mm, 2.47 kilos)

Nut drivers	5, 5.5, 6, 7, 8, 10, 11, 12, 13mm
T handle hex drivers	2.5, 3, 4, 5, 6, 7, 8mm
T handle TX/TPX drivers	T10, T15, T20, T25, T27, T30, T40

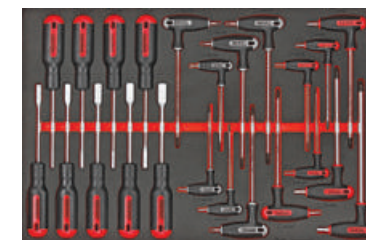

Nut Drivers

Mega Drive nut drivers. Chrome vanadium steel shank. 6 point opening. Ergonomically designed bi-material handle with hanging hole. DIN3125.

Stock No.	Size mm	Shaft length mm	Overall length mm	Weight g
MDN405	5.0	125	245	120
MDN4055	5.5	125	245	120
MDN406	6.0	125	245	120
MDN407	7.0	125	245	120
MDN408	8.0	125	245	120
MDN410	10.0	125	245	120
MDN411	11.0	125	245	120
MDN412	12.0	125	245	120
MDN413	13.0	125	245	120



Nut Drivers →

Stock No. Size mm Overall length mm

MDNT405	5.0	288
MDNT4055	5.5	288
MDNT406	6.0	288
MDNT407	7.0	288
MDNT408	8.0	288
MDNT409	9.0	288
MDNT410	10.0	288
MDNT411	11.0	288
MDNT412	12.0	288
MDNT413	13.0	288
MDNT414	14.0	288

T handle nut drivers

Mega Drive T Handle nut drivers with chrome vanadium steel shank with 6 point opening. Ergonomically designed bi-material handle with hanging hole. DIN3125.



T Handle Nut Drivers →



TTXTB09 3/8" drive extra long socket set

9 piece set with 3/8" drive sockets and a T bar with handle. Supplied in the unique Teng Tools drawer width TTX tray for use on it's own or as part of the Teng Tools TC control system. (570x115x70mm, 6.5 kilos)

Extra long sockets	8, 10, 12, 13, 14, 17, 19mm
Accessories	2 piece T bar handle



TBW10 3/8" Drive T Bar Deep Metric Socket Set

A 10 piece set of deep sockets with a T bar handle and 3/8" drive. Supplied with a T bar and plastic T handle grip in a handy storage wallet. (2.33 kilos).

300mm long deep sockets	3/8" drive	7, 8, 10, 12, 13, 14, 17, 19mm
Accessories	2 piece T bar handle	



3/8" drive T bar deep sockets

300mm long deep sockets with a T bar handle and 3/8" drive.

Stock No.	Size mm	Drive	L mm	D mm	Weight g
TBSKT07	7	3/8"	300	10.8	200
TBSKT08	8	3/8"	300	12.0	200
TBSKT10	10	3/8"	300	14.7	220
TBSKT12	12	3/8"	300	17.1	240
TBSKT13	13	3/8"	300	18.5	240
TBSKT14	14	3/8"	300	19.5	240
TBSKT17	17	3/8"	300	23.3	340
TBSKT19	19	3/8"	300	23.7	360

T-HD01	200mm x 8mm replacement bar for use with T Bar deep sockets
T-HD	for use with T-HD01 to form a comfortable to use T handle

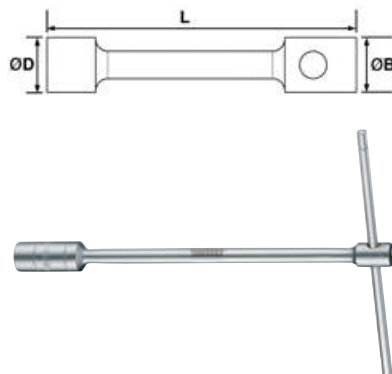

3/8" drive T bar deep sockets →

THHP08 Hook wrench set

Set consisting of 3 combined pin/hook spanners with 3 pin adaptors and 2 spare pins with 6 and 8mm diameters. Supplied in the unique Teng Tools TC tray with removable lid and dove tail joints for use on it's own or as part of the Teng Tools TC control system. (265x142x50mm, 1.1 kilos)

Hook handles	3/4" to 2", 1 1/4" to 3", 2" to 4 1/2"
Pin adaptors	4mm, 5mm, 6mm
Pins	6mm, 8mm



Hook Wrenches

Adjustable Hook Wrenches. With hook for locking nuts according to DIN 1804. Chrome vanadium.

Stock NO.	Capacity mm	Capacity inch	Overall length (closed) mm	Overall length (closed) in	Weight g
HP101	19 to 50	3/4" to 2	145	5 7/8	122
HP102	32 to 75	1 1/4" to 3	178	7	234
HP103	50 to 120	2" to 4 1/2"	247	9 7/8	447

Hook Wrenches →



Pin Wrenches

Adjustable Pin Wrenches. With fixed pin for locking nuts according to DIN 1816. Chrome vanadium.

Stock No.	Pin size	Capacity mm	Capacity inch	Overall length mm	Overall length in	Weight g
HP2014	4	19 to 50	3/4" to 2	145	5 7/8	122
HP2015	5	19 to 50	3/4" to 2	145	5 7/8	122
HP2025	5	32 to 75	1 1/4" to 3	178	7	227
HP2026	6	32 to 75	1 1/4" to 3	178	7	227
HP2036	6	50 to 120	2" to 4 1/2"	247	9 7/8	451
HP2038	8	50 to 120	2" to 4 1/2"	247	9 7/8	451



Pin Wrenches

Replacement Pins for Hook Wrenches

Being small items the pins in the pin wrenches can be mislaid, Teng Tools can supply the individual pins as required.

Stock No	Suitable for
HP2014-P	HP2014 hook wrench
HP2015-P	HP2015 & HP2025 hook wrenches
HP2026-P	HP2026 hook wrench
HP2036-P	HP2036 hook wrench
HP2038-P	HP2038 hook wrench

TTXQRS07 Quick wrench set

A set of 7 wrenches especially designed for loosening and tightening pipe and hose couplings. Ideal for use in confined spaces. The ring end has a clever design so that it opens up to easily access the nut on the coupling. Includes 13, 17, 19, 22, 24, 27, 32mm. Supplied in the unique Teng Tools drawer width TTX tray for use on it's own or as part of the Teng Tools TC control system (570x115x70mm, 1.88 kilos).



Quick wrenches for couplings and hose fittings

A wrench especially designed for loosening and tightening pipe and hose couplings. Ideal for use in confined spaces. The ring end has a clever design so that it opens up to easily access the nut on the coupling.

Stock No.	Size mm	L mm	D mm	H1 mm	H2 mm	Weight g
600813	13	141	27.5	7.2	8.0	92
600814	14	191	35.7	10.0	9.0	165
600816	16	191	35.7	10.0	9.0	165
600817	17	191	35.7	10.0	9.0	180
600819	19	191	35.7	10.0	9.0	225
600822	22	233	40.7	13.0	12.0	294
600824	24	235	43.2	13.0	12.0	300
600827	27	325	54.2	14.1	14.4	625
600830	30	325	56.4	15.9	14.4	610
600832	32	325	58.5	15.9	14.4	625

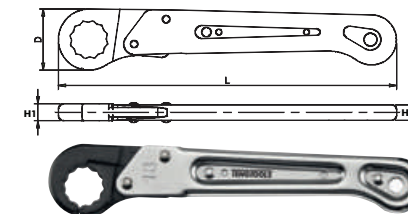

Quick Wrenches

Ratcheting Podgers

Podgers with two sizes per wrench. 12 point double ended sockets with a strong 32 tooth reversible ratchet mechanism.

Stock No.	Sizes mm	L mm	A mm	B mm	C mm	D mm	Weight g
PGW1719	17 x 19	315	42	50	26.0	26.3	450
PGW1922	19 x 22	315	42	50	26.0	29.5	450
PGW2124	21 x 24	315	42	50	28.0	32.0	462
PGW2730	27 x 30	366	65	63	36.6	40.0	1,350

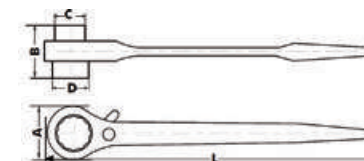



HEX KEYS

Teng Tools wide range of hex keys consists of a range of keys made of chrome vanadium steel for industrial use and a series made of chrome-molybdenum for heavy duty usage.

From standard keys and TX keys in chrome vanadium steel to extra-long and with ballpoint heads in chrome-molybdenum steel. In metric sizes from 1.5 mm up to a full 36 mm and in imperial sizes from 1/16" up to 3/8". They are available with a T-handle and in different sets.

In other words, here you'll find the hex key you need!

Hex keys with ballpoint heads

- Available in sets with metric sizes, imperial sizes and TX, with different options in terms of content and design, up to 10 mm.
- Up to 25 degree angle entry gives easy access, quick insertion and fast removal.
- Ideal for areas that are hard to reach.
- Ergonomic as they permit a natural hand and wrist movement.

Hex keys with T-handle

- Available in metric sizes, imperial sizes and TX, either individually or in TT sets or wall holder.

Folding sets

- Available in metric sizes, imperial sizes and TX.
- Anodised aluminium handle and plastic cores ensure stability and comfort in combination with a low weight.
- A stop mechanism means the keys can be opened out individually up to 90 degrees for easy and stable use even under torque.

Standard hex keys

- Available in sets in metric sizes, imperial sizes as well as individually up to 19 mm or 1/2" and in TX.



Hex Keys

TTHT28 Hex key set

Set of 28 ball point hex keys, (metric and AF) and TX keys. Supplied in the unique Teng Tools TC tray with removable lid and dove tail joints for use on it's own or as part of the Teng Tools TC control system. (265x142x50mm, 1,22 kilos)

Hex keys	mm	1.5, 2.0, 2.5, 3.0, 4.0, 5.0, 6.0, 7.0, 8.0, 10.0
Hex keys	AF	5/64" 3/32" 1/8" 5/32" 3/16" 7/32" 1/4" 5/16" 3/8"
TX key	TX	TX8, TX9, TX10, TX15, TX20, TX25, TX27, TX30, TX40



TEDHT42 Hex and TX wrench Set

A comprehensive set of hex and TX keys and wrenches. Supplied in the unique Teng Tools double width TC tray with removable lid and dove tail joints for use on it's own or as part of the Teng Tools TC control system. The tools are held in place using the Teng Tools three colour pre-cut EVA foam tool control system. (265x284x50m, 1.75 kilos)

Hex key sets	metric	1.5, 2, 2.5, 3, 4, 5, 6, 8, 10 and 7mm
	inch	5/64", 3/32", 1/8", 5/32", 3/16", 7/32", 1/4", 5/16", 3/8"
TX key set	TX	8, 9, 10, 15, 20, 25, 27, 30, 40
Fold up set		4, 5, 6mm hex, TX25, TX30, 1.0x5.5 flat, PH2, PZ2
Mini TX keys	TX	6, 7, 8, 9, 10, 15



1425 Metric hex key set

Set of 10 hex keys with holding ring. Chrome vanadium steel. Black.

Accessories	ring holder
Individual hex keys	1.5, 2.0, 2.5, 3.0, 4.0, 5.0, 6.0, 7.0, 8.0, 10.0mm



1424 AF hex key set

Set of 10 hex keys with ring holder. Chrome vanadium steel. Black.

Accessories	ring holder
Individual hex keys	1/16" 5/64" 3/32" 1/8" 5/32" 3/16" 7/32" 1/4" 5/16" 3/8"



1479MMR Metric hex key set

Set of 9 hex keys. Chrome vanadium steel. Black. In folding plastic holder.

Accessories	folding holder
Individual hex keys	1.5, 2.0, 2.5, 3.0, 4.0, 5.0, 6.0, 8.0, 10.0mm



Hex Keys

1479MMRL Extra long metric hex key set

9 piece extra long hex key set. Chrome vanadium steel. Individually size marked for easy identification. Supplied in folding plastic holder.

Accessories	folding holder
Individual hex keys	1.5, 2.0, 2.5, 3.0, 4.0, 5.0, 6.0, 8.0, 10.0mm



1476NMM metric hex key set

7 piece hex key set. Chrome vanadium steel. Retractable in aluminium case. DIN2936.

Accessories	ergonomically designed aluminium holder
Individual hex keys	1.5, 2.0, 2.5, 3.0, 4.0, 5.0, 6.0mm



1476NMM1 metric hex key set

7 piece hex key set. Chrome vanadium steel. Retractable in aluminium case. DIN2936.

Accessories	ergonomically designed aluminium holder
Individual hex keys	2.5, 3.0, 4.0, 5.0, 6.0, 8.0, 10.0mm



1477NX Assorted Key Set

8 piece set including hexagon, TX and screwdriver keys. Chrome vanadium steel. Retractable in aluminium case.

Accessories	ergonomically designed aluminium holder
Individual hex keys	4, 5, 6mm
Individual TX keys	TX25, TX30
Individual Screwdriver keys	1.0x5.5mm flat, PH1, PZ2



1473 Bicycle Tool Kit

11 piece set especially designed for cyclists and including hexagon, TX and screwdriver keys, a tyre lever and a chain tool. Chrome nickel finish. Retractable in aluminium case.

Accessories	ergonomically designed aluminium holder, tyre lever and chain tool
Individual hex keys	2, 2.5, 3, 4, 5, 6mm
Individual TX keys	TX25
Individual Screwdriver keys	1.0x5.5mm flat, PH2



1476NAF AF hex key set

7 piece hex key set. Chrome vanadium steel. Retractable in aluminium case. DIN2936.

Accessories	ergonomically designed aluminium holder
Individual hex keys	1/16" 5/64" 3/32" 1/8" 5/32" 3/16" 7/32"

**1471MM Metric hex key set**

7 piece hex key set. Chrome vanadium steel. Retractable in chromed case. Features a fold out ring connector for use with a safety wire such as the Teng Tools SSH range of safety wires included in the Service Tools section of this catalogue.

Accessories	chrome plated metal holder with safety wire connector
Individual hex keys	1.5, 2.0, 2.5, 3.0, 4.0, 5.0, 6.0mm

**1471MMA Metric hex key set**

7 piece hex key set. Chrome vanadium steel. Retractable in chromed case. Features a fold out ring connector for use with a safety wire such as the Teng Tools SSH range of safety wires included in the Service Tools section of this catalogue.

Accessories	chrome plated metal holder with safety wire connector
Individual hex keys	2.5, 3.0, 4.0, 5.0, 6.0, 8.0, 10.0mm

**1471AF AF hex key set**

7 piece hex key set. Chrome vanadium steel. Retractable in chromed case. Features a fold out ring connector for use with a safety wire such as the Teng Tools SSH range of safety wires included in the Service Tools section of this catalogue.

Accessories	chrome plated metal holder with safety wire connector
Individual hex keys	1/16", 5/64", 3/32", 1/8", 5/32", 3/16", 7/32"

**1471AFA AF hex key set**

6 piece hex key set. Chrome vanadium steel. Retractable in chromed case. Features a fold out ring connector for use with a safety wire such as the Teng Tools SSH range of safety wires included in the Service Tools section of this catalogue.

Accessories	chrome plated metal holder with safety wire connector
Individual hex keys	1/8", 5/32", 3/16", 1/4", 5/16", 3/8"

**1474 AF Ball point hex key set**

Set of 7 hex keys. Chrome vanadium steel. Black. With ball point heads on the long key end which permits turning at a 30° angle. Supplied in plastic holder.

Accessories	self locking plastic handle
Individual hex keys	1/8" 5/32" 3/16" 7/32" 1/4" 5/16" 3/8"

**1475 Metric ball point hex key set**

Set of 7 hex keys. Chrome vanadium steel. Black. With ball point heads on the long key end which permits turning at a 30° angle. Supplied in plastic holder.

Accessories	self locking plastic handle
Individual hex keys	2.5, 3.0, 4.0, 5.0, 6.0, 8.0, 10.0mm

**1479MM Metric ball point hex key set**

Set of 9 metric chrome vanadium steel hex keys. With ball point head on the long key end for 30° access. Supplied in folding plastic holder.

Accessories	folding holder
Individual hex keys	1.5, 2.0, 2.5, 3.0, 4.0, 5.0, 6.0, 8.0, 10.0mm

**1479MMA Metric ball point hex key set**

Set of 9 chrome vanadium steel hex keys. With ball point head on the long key end for 30° access. Supplied in folding plastic holder.

Accessories	folding holder
Individual hex keys	1.5, 2.0, 2.5, 3.0, 4.0, 5.0, 6.0, 7.0, 10.0mm

**1499MM chrome molybdenum hex key set**

Set of 9 chrome molybdenum alloy steel hex keys for added strength. With ball point end on the long hex key end for 30° access. Supplied in folding plastic holder.

Accessories	folding holder
Individual hex keys	1.5, 2.0, 2.5, 3.0, 4.0, 5.0, 6.0, 8.0, 10.0mm



1479AF AF ball point hex key set

Set of 9 AF chrome vanadium steel hex keys.
With ball point head on the long key end for 30° access.
Supplied in folding plastic holder.

Accessories	folding holder
Individual hex keys	5/64" 3/32" 1/8" 5/32" 3/16" 7/32" 1/4" 5/16" 3/8"



1499AF chrome molybdenum hex key set

Set of 9 chrome molybdenum alloy steel hex keys for added strength. With ball point end on the long hex key end for 30° access. Supplied in folding plastic holder.

Accessories	folding holder
Individual hex keys	5/64", 3/32", 1/8", 5/32", 3/16", 7/32", 1/4", 5/16", 3/8"



Individual Metric Hex Keys

Individual metric hex keys with dimension marked on each black key. Individually carded. DIN2936.

Stock No.	Size mm	short arm length mm	long arm length mm
3105007	0.7	8	35
3105009	0.9	10	38
3105013	1.3	12	41
3105015	1.5	14	45
310502	2.0	16	50
3105025	2.5	18	56
310503	3.0	20	63
310504	4.0	25	70
3105045	4.5	26	75
310505	5.0	28	80
3105055	5.5	30	85
310506	6.0	32	90
310507	7.0	34	95
310508	8.0	36	100
310509	9.0	38	106
310510	10.0	40	112
310512	12.0	45	125
310514	14.0	56	140
310517	17.0	63	160
310519	19.0	70	180
310522	22.0	80	200
310527	27.0	100	250
310532	32.0	125	315
310536	36.0	140	355



Individual Metric Hex Keys →

Individual extra long metric hex keys

Individual extra long metric hex keys each individually marked with the size. Chrome vanadium steel.

Stock No.	Size mm	short arm length mm	long arm length mm
3205015	1.5	14	90
320502	2.0	16	100
3205025	2.5	18	112
320503	3.0	20	126
320504	4.0	25	140
320505	5.0	28	160
320506	6.0	32	180
320508	8.0	36	200
320510	10.0	40	224



Individual AF hex keys

Individual AF hex keys with dimension marked on each black key. Ground key ends. Loose. DIN2936.

Stock No.	Size AF	short arm length mm	long arm length mm
310102	1/16"	14	44
3101025	5/64"	15	48
310103	3/32"	17	51
3101035	7/64"	18	54
310104	1/8"	19	57
3101045	9/64"	20	60
310105	5/32"	21	64
310106	3/16"	24	70
310107	7/32"	26	76
310108	1/4"	28	83
310110	5/16"	32	95
310112	3/8"	35	108
310114	7/16"	38	121
310116	1/2"	41	133



Individual AF Hex Keys →

Individual Metric ball point hex keys

Individual hex key wrenches. Chrome vanadium. Black.
With ball point heads on the long end which permits turning at a 30° angle. Individually carded.

Stock No.	Size mm	short arm length mm	long arm length mm
3105015BL-C	1.5	17	76
310502BL-C	2.0	19	83
3105025BL-C	2.5	20	90
310503BL-C	3.0	22	99
310504BL-C	4.0	28	111
310505BL-C	5.0	32	126
310506BL-C	6.0	38	143
310507BL-C	7.0	34	144
310508BL-C	8.0	44	160
310510BL-C	10.0	50	180

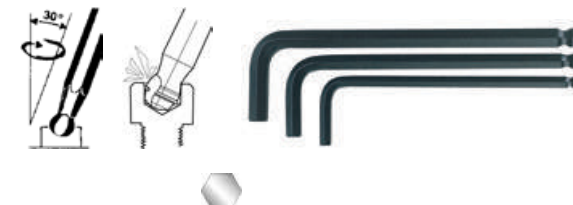

Individual Metric Ball Point Hex Keys →

Individual chrome molybdenum ball point metric hex keys

Individual chrome molybdenum hexagon keys for added strength. With ball point ends on the long end which permits turning at a 30° angle. Individually size marked for easy identification.

Stock No.	Size mm	short arm length mm	long arm length mm
3905015BL	1.5	14	77
390502BL	2.0	16	83
3905025BL	2.5	18	90
390503BL	3.0	20	98
390504BL	4.0	25	106
390505BL	5.0	28	118
390506BL	6.0	32	137
390508BL	8.0	36	156
390510BL	10.0	40	170



Individual AF ball point hex keys

Individual AF hex key wrenches. Chrome vanadium. Black.
With ball point heads on the long end which permits turning at a 30° angle. Individually carded.

Stock No.	Size AF	Short arm length mm	Long arm length mm
3101025BL	5/64"	15	82
310103BL	3/32"	17	88
310104BL	1/8"	19	96
310105BL	5/32"	21	105
310106BL	3/16"	24	114
310107BL	7/32"	26	124
310108BL	1/4"	28	135
310110BL	5/16"	32	151
310112BL	3/8"	35	170

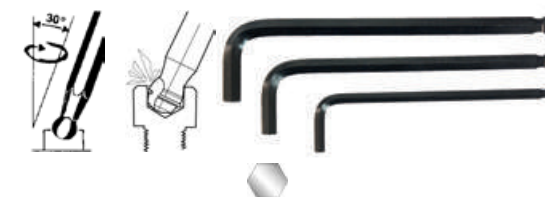

Individual Ball Point Hex Keys

Hex Keys

Individual chrome molybdenum ball point AF hex keys

Individual chrome molybdenum hexagon keys for added strength. With ball point ends on the long end which permits turning at a 30° angle. Individually size marked for easy identification.

Stock No.	Size mm	short arm length mm	long arm length mm
3901025BL	5/64"	15	82
390103BL	3/32"	17	88
390104BL	1/8"	19	96
390105BL	5/32"	21	105
390106BL	3/16"	24	114
390107BL	7/32"	26	124
390108BL	1/4"	28	135
390110BL	5/16"	32	151
390112BL	3/8"	35	170



TTHEX7 T Handle hex key set

Set of 7 hex keys with T handle. The ball point head on the long key end improves access. Supplied in the unique Teng Tools TC tray with removable lid and dove tail joints for use on it's own or as part of the Teng Tools TC control system. (265x142x50mm, 0.72 kilos)

T handle driver	hex/ball point	100mm (long arm)	2.5, 3, 4mm
T handle driver	hex/ball point	150mm (long arm)	5, 6, 7mm
T handle driver	hex/ball point	190mm (long arm)	8mm



TTHEX7S Individual Metric T Handle Hex Drivers **NEW!**

Set of hex keys with T handle. Both ends with regular hexagon fitting. (ie. no ball point) Supplied in the unique Teng Tools TC tray with removable lid and dove tail joints for use on it's own or as part of the Teng Tools TC control system. (265x142x50mm, 0.8 kilos)

T handle driver	hex point	100mm (long arm)	2.5, 3, 4mm
T handle driver	hex point	150mm (long arm)	5, 6, 7mm
T handle driver	hex point	190mm (long arm)	8mm



TEDHEX7 T handle Hex Key Set

7 piece set of T handle hex keys with ball point ends on the long key end. Supplied in the unique Teng Tools double width TC tray with removable lid and dove tail joints for use on it's own or as part of the Teng Tools TC control system. The tools are held in place using the Teng Tools three colour pre-cut EVA foam tool control system. (265x284x50mm, 1.11 kilos)

T handle hex keys	2.5, 3, 4, 5, 6, 7, 8mm
-------------------	-------------------------



WRHEX07 T handle hex key set

7 piece metric T handle hex key set with a ball point end on the long arm for 30° access. Complete with a wall rack for fixing to the wall or a work bench.

T handle hex keys	2.5, 3, 4, 5, 6, 7, 8mm
-------------------	-------------------------

Hex Keys

TTEX23 Wrenches set

Set containing metric T handle nut drivers and metric hex and TX/TPX T handle drivers. Supplied in the Teng Tools three colour pre-cut EVA foam tool control system. (570x375x75mm, 2.47 kilos)

Nut drivers	5, 5.5, 6, 7, 8, 10, 11, 12, 13mm
T handle hex drivers	2.5, 3, 4, 5, 6, 7, 8mm
T handle TX/TPX drivers	T10, T15, T20, T25, T27, T30, T40

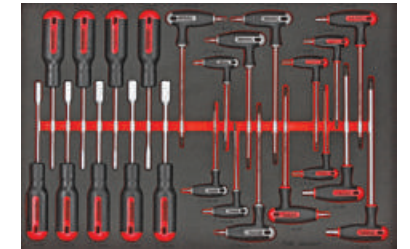

Individual Metric T handle hex drivers

Hex keys with T handle. With ball point head on the long key end, which improves access.

Stock No.	Size mm	short arm length mm	long arm length mm
510502	2.0	12	100
5105025	2.5	12	100
510503	3.0	12	100
510504	4.0	12	100
510505	5.0	15	150
510506	6.0	15	150
510507	7.0	15	150
510508	8.0	18	190
510510	10.0	20	200
510512	12.0	20	200

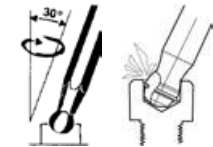

Individual Metric T handle Hex Drivers →

Individual Metric T Handle Hex Drivers **NEW!**

- Prevents wear inside hexagon socket screws.
- Provides larger contact zones in the screw head
- Ergonomically designed bi-material handle



Stock No.	Size mm	Short arm length mm	Short arm length mm	Weight g
5106025	2.5	15	100	20
510603	3.0	15	100	25
510604	4.0	15	100	37
510605	5.0	18	150	80
510606	6.0	18	150	100
510607	7.0	18	150	120
510608	8.0	18	190	180

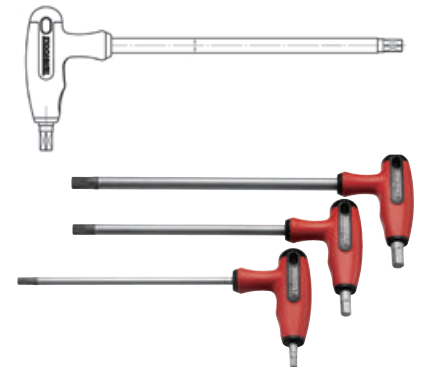

Hex type screwdrivers

Hex type screwdrivers, with ergonomically designed bi-material handle with hanging hole. TT-MV plus steel, black tips.

Stock No.	Size mm	shaft type	Tip	L1 mm	L2 mm
MD7020HN	2	Round	hex	100	196
MD7025HN	2.5	Round	hex	100	196
MD7030HN	3	Round	hex	100	196

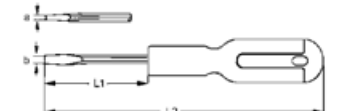

Hex Type Screwdrivers →

Hex screwdrivers - ball type

Hex type screwdrivers with a ball pointed end, ergonomically designed bi-material handle with hanging hole. TT-MV plus steel, black tips.

Stock No.	Size mm	shaft type	Tip	L1 mm	L2 mm
MD7020HBN	2	Round	hex ball	100	196
MD7025HBN	2.5	Round	hex ball	100	196
MD7030HBN	3	Round	hex ball	150	246
MD7040HBN	4	Round	hex ball	150	258
MD7050HBN	5	Round	hex ball	150	266
MD7060HBN	6	Round	hex ball	150	266
MD7080HBN	8	Round	hex ball	150	275

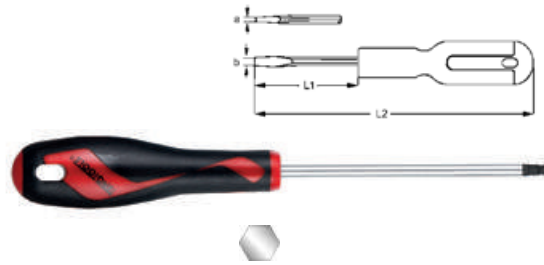

Hex Screwdrivers - Ball Type →

TTHEX7AF T Handle AF hex key set

Set of 7 hex keys with T handle. The ball point head on the long key end improves access. Supplied in the unique Teng Tools TC tray with removable lid and dove tail joints for use on it's own or as part of the Teng Tools TC control system. (265x142x50mm, 0.75 kilos)

T handle driver hex/ball point	100mm (long arm)	3/32" 1/8" 5/32"
T handle driver hex/ball point	150mm (long arm)	3/16" 7/32" 1/4"
T handle driver hex/ball point	190mm (long arm)	5/16"



WRHEX07AF T handle hex key set

7 piece imperial T handle hex key set with a ball point end on the long arm for 30° access. Complete with a wall rack for fixing to the wall or a work bench.

T handle hex keys	3/32", 1/8", 5/32", 3/16", 7/32", 1/4", 5/16"
-------------------	---

Individual AF T Handle Hex Drivers

Hex keys with T handle. With ball point head on the long key end, which improves access. CrMo alloy steel for extra strength.

Stock No.	Size AF	short arm length mm	long arm length mm
510103	3/32"	12	100
510104	1/8"	12	100
510105	5/32"	12	100
510106	3/16"	12	100
510107	7/32"	15	150
510108	1/4"	15	150
510110	5/16"	15	150

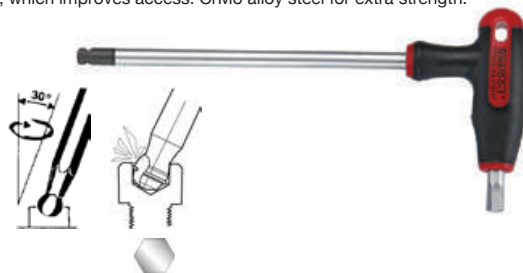

T handle Hex Drivers →

1479TX TX key set

TX keys for internal TX heads. Chrome vanadium steel. Supplied in plastic holder.

Accessories	folding holder
Individual TX keys	TX8, TX9, TX10, TX15, TX20, TX25, TX27, TX30, TX40

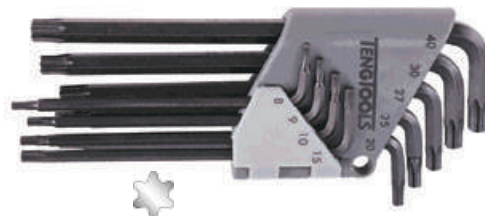

Individual TX keys

TX keys for internal heads, made of chrome vanadium steel. DIN2936.

Stock No.	Size TX	Max head width mm	For screws M	Length mm
320008	8	2.31	2.5	16x80
320009	9	2.50	3.0	16x83
320010	10	2.74	3.0-3.5	17x86
320015	15	3.27	3.5-4.0	18x90
320020	20	3.86	4.0-5.0	19x95
320025	25	4.43	4.5-5.0	20x100
320027	27	4.99	4.5-6.0	22x105
320030	30	5.52	6.0-7.0	24x114
320040	40	6.65	7.0-8.0	26x124
320045	45	7.82	8.0-10.0	29x133
320050	50	8.83	10.0	32x152



TX Keys →

1479TX1 TX key set with ball point heads

TX keys for internal TX heads with a ball point end for easier access at an angle. Chrome vanadium steel. Supplied in a plastic holder.

Accessories	folding holder
Individual TX keys	TX8, TX9, TX10, TX15, TX20, TX25, TX27, TX30, TX40



Individual ball point TX keys

TX keys for internal heads with ball point ends, made of chrome vanadium steel.

Stock No.	Size TX	Max head width mm	For screws M	Length mm
320008BL	8	2.31	2.5	16x80
320009BL	9	2.50	3.0	16x83
320010BL	10	2.74	3.0-3.5	17x86
320015BL	15	3.27	3.5-4.0	18x90
320020BL	20	3.86	4.0-5.0	19x95
320025BL	25	4.43	4.5-5.0	20x100
320027BL	27	4.99	4.5-6.0	22x105
320030BL	30	5.52	6.0-7.0	24x114
320040BL	40	6.65	7.0-8.0	26x124
320045BL	45	7.82	8.0-10.0	29x133
320050BL	50	8.83	10.0	32x152



Ball Point Hex Keys →

1487 TX key set

Set of 7 TX keys with a ring holder. For internal TX heads. Chrome vanadium steel.

Accessories	ring holder
Individual TX keys	TX10, TX15, TX20, TX25, TX27, TX30, TX40



1476NTX TX key set

8 piece TX key set. Chrome vanadium steel. Retractable in aluminium case.

Accessories	aluminium case with nylon inserts
Individual TX keys	TX9, TX10, TX15, TX20, TX25, TX27, TX30, TX40



1476NTX1 TX key set with ball point heads

8 piece TX key set with ball point heads for 20° access. Chrome vanadium steel. Retractable in aluminium case.

Accessories	ergonomically designed aluminium holder
Individual TX keys	TX9, TX10, TX15, TX20, TX25, TX27, TX30, TX40



1476NTX2 chrome molybdenum TX key set

8 piece TX key set. Chrome molybdenum steel for added strength. Retractable in chromed case. Features a fold out ring connector for use with a safety wire such as the Teng Tools SSH range of safety wires included in the Service Tools section of this catalogue.

Accessories	chrome plated metal holder with safety wire connector
Individual TX keys	TX9, TX10, TX15, TX20, TX25, TX27, TX30, TX40



1499TX chrome molybdenum TX key set

Set of 9 chrome molybdenum alloy steel TX keys for added strength. With ball point end on the long hex key end for 20° access. Supplied in folding plastic holder.

Accessories	folding holder
Individual TX keys	TX8, TX9, TX10, TX15, TX20, TX25, TX27, TX30, TX40



Individual chrome molybdenum ball point TX keys

Individual chrome molybdenum TX keys for added strength. With ball point ends on the long end which permits turning at a 20° angle. Individually size marked for easy identification.

Stock No.	Size TX	short arm length mm	long arm length mm
390908BL	8	16	80
390909BL	9	16	83
390910BL	10	17	86
390915BL	15	18	90
390920BL	20	19	95
390925BL	25	20	100
390927BL	27	22	105
390930BL	30	24	114
390940BL	40	26	124



276

TTEX7 T Handle hex key set

Set of 7 TX keys with T handle. For internal TX heads (also for tamper proof screws). Supplied in the unique Teng Tools TC tray with removable lid and dove tail joints for use on it's own or as part of the Teng Tools TC control system. (265x142x50mm, 0.72 kilos)

T handle driver	TX/TPX	100mm (long arm)	TX/TPX10, TX/TPX15, TX/TPX20
T handle driver	TX/TPX	150mm (long arm)	TX/TPX25, TX/TPX27, TX/TPX30
T handle driver	TX/TPX	190mm (long arm)	TX/TPX40



TEDTX7 T handle TX Key Set

7 piece set of T handle TX keys with TPX ends on the long key end. Supplied in the unique Teng Tools double width TC tray with removable lid and dove tail joints for use on it's own or as part of the Teng Tools TC control system. The tools are held in place using the Teng Tools three colour pre-cut EVA foam tool control system. (265x284x50mm, 0.98 kilos)

T handle TX keys	TX10, TX15, TX20, TX25, TX27, TX30, TX40
------------------	--



WRTX07 T handle TX key set

7 piece T handle TX key set with a TPX end on the long arm for tamper proof TX fastenings. Complete with a wall rack for fixing to the wall or a work bench.

T handle TX keys	TX10, TX15, TX20, TX25, TX27, TX30, TX40
------------------	--



T handle TX/TPX Drivers

TX keys with T handle for internal TX heads. Long key end also has a slot for tamper proof screws. CrMo alloy steel for extra strength.

Stock No.	Size	short arm length mm	long arm length mm
520009	TX/TPX9	12	100
520010	TX/TPX10	12	100
520015	TX/TPX15	12	100
520020	TX/TPX20	12	100
520025	TX/TPX25	15	150
520027	TX/TPX27	15	150
520030	TX/TPX30	15	150
520040	TX/TPX40	18	190
520045	TX/TPX45	20	200
520050	TX/TPX50	20	200
520055	TX/TPX55	20	200

T handle TX/TPX drivers →



277

HOW TO USE A TORQUE WRENCH

TORQUE PLUS RANGE

Compact, lightweight and reliable

Always:

- Always use a torque wrench to apply a specific torque value. Never use it as the primary means of tightening or loosening fasteners.
- Always clean dirty or rusted threads before tightening.
- Always carry a torque wrench with care. A single fall can knock the accuracy off by as much as 30 percent. If you do drop it, get it recalibrated.
- Always store a torque wrench in its protective case when not in use.
- Always apply torque in a slow, methodical manner. Avoid sudden, jerking movements.
- Always grasp a torque wrench in the centre of the handle. If two hands are needed, place one hand on top of the other.
- Always return a torque wrench to the 'zero' setting before storage.
- Always use the correct drive of torque wrench to suit the size of the fastening you need to turn.

Never:

- Never use a torque wrench as a breaker bar. This will damage the torque mechanism.
- Never exceed the recommended working range of a torque wrench.



Teng Tools torque wrenches have quickly become one of the most used within the automotive sector as well as light industry. This new range of industrial quality 'Plus' torque wrenches are supplied with a fully traceable calibration certificate from the date of manufacture. They are 72 teeth which allows for accessibility in confined spaces and they perform to an accuracy of $\pm 4\%$ which meets international standards.

Stock No.	Drive	Range (Nm)	Scale (Nm)
3892P060	3/8"	12-60	0.5
3892P100	3/8"	20-100	0.5
1292P100	1/2"	20-100	0.5
1292P200	1/2"	40-200	1.0
1292P320	1/2"	60-320	2.0
3492P500	3/4"	100-500	2.5

Get organised™



Torque Tester

A digital test instrument designed to check torque wrench readings. Robust and easy to use with fixing points for installation on a solid surface such as a work bench. Accuracy is +/-1% of the measurement value and a factory test certificate is included. For clockwise measurement.



Stock No.	Plug type	Range Nm	Depth mm	Width mm	Height mm	Weight g
TORQ02	Euro	1.5-30	205	155	76	2,940
TORQ03	Euro	7.5-150	205	155	76	3,940
TORQ04	Euro	25-500	205	155	76	4,060
TORQ05	Euro	50-1,000	205	155	76	4,060

Torque Tester

A digital test instrument designed to check torque wrench readings. Can also be connected to the Teng Tools TORP01 printer to print off a record of the readings taken. Robust and easy to use with fixing points for installation on a solid surface such as a work bench. Accuracy is +/-1% of the measurement value and a factory test certificate is included. For clockwise measurement.



Stock No.	Plug type	Range Nm	Depth mm	Width mm	Height mm	Weight g
TORQ99E	Euro	10-400	200	160	85	2,500

Torque Test Printer

A printer to print off a record of the readings taken on the TORQ99 torque wrench tester.



Stock No.	Plug type	Depth mm	Width mm	Height mm	Weight g
TORP01E	Euro	220	180	95	1,840

TORQ99 Stand for Torque Wrench Tester and Printer

Metal stand designed specifically for the Teng Tools TORQ99 tester and TORP01 printer. Measures 570x340x950mm, weight 1.64 kilos.



Torque Tester with Stand and Printer

Torque test centre complete with stand, printer and torque wrench tester (TORQ99)

Stock No.	Plug type	Depth mm	Width mm	Height mm	Weight g
TORQ	Euro	570	340	950	43.5



TTSD39 Torque screwdriver set

1/4" drive torque screwdriver with "slipper" mechanism for when torque is reached. Supplied with 36 bits, 4" extension bar and bit chuck holder. Supplied in the unique Teng Tools TC tray with removable lid and dove tail joints for use on it's own or as part of the Teng Tools TC control system. (265x142x50mm, 0.66 kilos)

25mm Bits	1/4" hex	PH0, PH1, PH2, PH3 PZ0, PZ1, PZ2, PZ3 TX8, TX9, TX10, TX15, TX20, TX25, TX27, TX30, TX40 TPX10, TPX15, TPX20, TPX25, TPX30 ROB1, ROB2, ROB3 GR PH2x2 pc hex 2, 3, 4, 5, 6mm flat 3.0x0.5mm, 4.5x0.6mm 5.5x0.8mm, 6.5x1.2mm
Accessories	1/4" drive 1/4" hex	torque screwdriver 1-5Nm, 4" extension bar bit chuck holder



Get Organised with Teng Tools - be more efficient and save time and money.

TEDSD95 Torque Screwdriver, Impact Driver and Bit Set

1/4" drive 1-5Nm torque screwdriver and 1/2" drive impact driver together with assorted bits to suit most types of fastenings. Supplied in the unique Teng Tools double width TC tray with removable lid and dove tail joints for use on it's own or as part of the Teng Tools TC control system. The tools are held in place using the Teng Tools three colour pre-cut EVA foam tool control system. (265x284x50mm, 2.40 kilos)



Accessories	1/4" drive	1-5Nm torque screwdriver, quick release chuck, sliding T bar, 6" flexible extension, Ratchetting bits driver with assorted bits in the handle (5, 7mm flat, PH1, PH2, PZ1, PZ2, 1/4"M:1/4" hex adaptor)
	3/8" drive	3/8"M:5/16" hex adaptor
	1/2" drive	impact driver, 5/16" hex bit adaptor
5/16" hex 36mm bits	flat type	1.4x6, 1.4x8, 2.2x10, 1.8x12mm
	PH	PH1, PH2, PH3, PH4
	hex	4, 5, 6, 8mm
	TX	TX30, TX40, TX45, TX50, TX55
1/4" hex 25mm bits	flat type	0.6x3.5, 0.6x4.5, 0.8x4.0, 0.8x5.5, 1.0x5.5, 1.2x6.5, 1.6x8.0mm
	PH	PH1 (x3), PH2 (x6), PH3
	PZ	PZ1 (x3), PZ2 (x6), PZ3
	hex	2, 3, 4, 5, 6, 8mm
	TX	TX6, TX7, TX8, TX9, TX10, TX15, TX20 (x3), TX25 (x3), TX27, TX30, TX40
	TPX	TPX10, TPX15, TPX20 (x2), TPX25 (x2), TPX27, TPX30, TPX40
	Square	1, 2, 3
	GR	2 (x3)

Torque Screwdrivers

1/4" drive torque screwdriver with "slipper" mechanism for when torque is reached. Ranges covered 1-5 Nm and 2-8Nm.

Stock No.	Description	Range NM
1492SD	torque screwdriver	1-5

Torque Screwdrivers →



Torque Screwdrivers – CT version

All Teng Tools torque wrenches are individually tested and certified at the time of manufacture. However, we are also able to offer torque wrenches with a certificate of tests conducted at the time of despatch from our central warehouse. All tests and equipment conform to the relevant ISO standards and individual torque wrenches will be checked and a certificate issued at the time the order is placed with us. The cost of this service is included in the price of CT type torque wrenches as shown in the table.

Stock No.	Description	Range NM
1492SD-CT	torque screwdriver calibrated	1-5

Torque Screwdrivers →



1492AG-E 1/4" Drive Torque Wrench

Torque wrench according to ISO6789. With ratchet the torque wrench can be used for both tightening, and final checking of the torque. Reversible with lever, but only for right-hand action for torque checking. Equipped with angular gauge for after tightening. Graduated in Nm and ft/lbs. Lockable setting. Accuracy +/-4%. Satin finish.

Stock No.	Range Nm	Range ft/lb	Scale Nm	Scale ft/lb	L mm	W mm	H mm	Weight g
1492AG-E	5-25	4-18	0.4	0.4	277	27.6	20.6	580



282

1492AG-CT 1/4" Drive Torque Wrench – CT version

All Teng Tools torque wrenches are individually tested and certified at the time of manufacture. However, we are also able to offer torque wrenches with a certificate of tests conducted at the time of despatch from our central warehouse. All tests and equipment conform to the relevant ISO standards and individual torque wrenches will be checked and a certificate issued at the time the order is placed with us. The cost of this service is included in the price of CT type torque wrenches as shown in the table.

Stock No.	Range Nm	Range ft/lb	Scale Nm	Scale ft/lb	L mm	W mm	H mm	Weight g
1492AG-CT	5-25	4-18	0.4	0.4	277	27.6	20.6	580



TTX3892 3/8" Torque Wrench set

22 piece set consisting of a 3/8" drive torque wrench, 10 crow foot wrenches, bit adaptor, 8 TX bits, 3" and 5" extension bars. Supplied in the unique Teng Tools TC tray for use on it's own or as part of the Teng Tools TC control system. (570x115x60mm, 0.9 kilos)

Torque wrench	3/8" drive	angular gauge torque wrench(20-110Nm, 15-75 ft/lb)
Accessories	3/8" drive	3" and 5" extensions, adaptor for 10mm hex bits
TX bits	10mm hex drive	TX8, TX10, TX15, TX20, TX25, TX27, TX30, TX40
Crow foot wrenches	3/8" drive	10, 11, 12, 13, 14, 15, 16, 17, 18, 19mm



Torque wrench	3/8" drive	20-110Nm (15-81ft/lb)
	1/2" drive	40-210Nm (30-150 ft/lb)



TEX1238 Torque Wrench Set

1/2" drive and 3/8" drive angular gauge torque wrenches covering 20-210Nm (15-150 ft/lb) in total. Supplied in the unique Teng Tools drawer width TTX tray for use on it's own or as part of the Teng Tools TC control system. The tools are held in place using the Teng Tools three colour pre-cut EVA foam tool control system. (570x115x60mm, 2.77 kilos)

3/8" Drive Torque Wrenches

Torque wrench according to ISO6789. With ratchet the torque wrench can be used for both tightening and final checking of the torque. Reversible with lever, but only for right hand action for torque checking. Equipped with angular gauge for after tightening. Graduated in Nm and ft/lbs. Lockable setting. Accuracy +/-4%. Satin finish.

3/8" Drive Torque Wrenches →

Stock No.	Range Nm	Range ft/lb	Scale Nm	Scale ft/lb	L mm	W mm	H mm	Weight g
3892AG-E1	5-25	4-18	0.4	0.4	277	27.6	20.6	580
3892AG-E3	20-110	15-75	1.0	1.0	368	35.9	27.7	580



3/8" Drive Torque Wrenches - CT Version

All Teng Tools torque wrenches are individually tested and certified at the time of manufacture. However, we are also able to offer torque wrenches with a certificate of tests conducted at the time of despatch from our central warehouse. All tests and equipment conform to the relevant ISO standards and individual torque wrenches will be checked and a certificate issued at the time the order is placed with us. The cost of this service is included in the price of CT type torque wrenches as shown in the table.

3/8" Drive Torque Wrenches - CT Version →

Stock No.	Range Nm	Range ft/lb	Scale Nm	Scale ft/lb	L mm	B mm	H mm	Weight g
3892AG1-CT	5-25	4-18	0.4	0.4	277	27.6	20.6	580
3892AG3-CT	20-110	15-75	1.0	1.0	368	35.9	27.7	580



283

3/8" Drive Torque Plus Torque Wrenches

NEW!

Industrial grade torque wrenches designed and manufactured to exceed ISO6789 with an accuracy of +/- 4% maximum. Each torque wrench is supplied with an individual, fully traceable calibration certificate from the date of manufacture. A 72 teeth ratchet mechanism allows for greater access even in confined spaces and incorporates a quick release mechanism and twist reverse for changing direction but torque is only measurable in the conventional right hand direction. The scale is an easy to read window style Nm scale while the handle has an ergonomically designed bi-material grip for added comfort and a hanging facility that can also be used in conjunction with a Teng Tools safety wire for added security when working at heights. The Plus torque wrenches also feature a safety locking button to enable reliable locking of the torque setting.

Stock No.	Range Nm	Scale Nm	L mm	W mm	H mm	Weight g
3892P060	12-60	0.5	380	36	36	930
3892P100	20-100	0.5	410	36	36	960



3/8" Drive Torque Plus Torque Wrenches – CT version

NEW!

All Teng Tools torque wrenches are individually tested and certified at the time of manufacture. However, we are also able to offer torque wrenches with a certificate of tests conducted at the time of despatch from our central warehouse. All tests and equipment conform to the relevant ISO standards and individual torque wrenches will be checked and a certificate issued at the time the order is placed with us. The cost of this service is included in the price of CT type torque wrenches as shown in the table.

Stock No.	Range Nm	Scale Nm	L mm	W mm	H mm	Weight g
3892P060-CT	12-60	0.5	380	36	36	930
3892P100-CT	20-100	0.5	410	36	36	960



3892D100 3/8" Drive Electronic/Digital Torque Wrench

An easy to use electronic, digital torque wrench. 9 separate torque settings with individual torque, percentage tolerance and unit settings to enable the torque wrench to be pre-programmed for different torque tolerances before use. An audio visual warning system alerts the user with an orange light before, a green light on and a red light after the target torque is reached. Accuracy +/- 1%, reading in Nm, ft/lb, in/lb and kg/m. Quick release mechanism on the square drive and bi-directional torque facility. Each torque setting has an individual recallable memory storing the last nine settings. Uses standard AA batteries and supplied in a storage case for protection and convenient storage when not in use. The torque wrench meets or exceeds the demands according to ISO6789:2003 and is supplied with a certificate of calibration at the time of production.

Stock No.	Range Nm	Range ft/lb	Scale Nm	Scale ft/lb	L mm	W mm	H mm	Weight g
3892D100	10-100	7-75	0.1	0.1	457	42.5	46.5	904



3892D100-CT 3/8" Drive Electronic/Digital Torque Wrench – CT version

An easy to use electronic, digital torque wrench. 9 separate torque settings with individual torque, percentage tolerance and unit settings to enable the torque wrench to be pre-programmed for different torque tolerances before use. An audio visual warning system alerts the user with an orange light before, a green light on and a red light after the target torque is reached. Accuracy +/- 1%, reading in Nm, ft/lb, in/lb and kg/m. Quick release mechanism on the square drive and bi-directional torque facility. Each torque setting has an individual recallable memory storing the last nine settings. Uses standard AA batteries and supplied in a storage case for protection and convenient storage when not in use. The torque wrench meets or exceeds the demands according to ISO6789:2003 and is supplied with a certificate of calibration issued at the time the order is placed with us.

Stock No.	Range Nm	Range ft/lb	Scale Nm	Scale ft/lb	L mm	W mm	H mm	Weight g
3892D100-CT	10-100	7-75	0.1	0.1	457	42.5	46.5	904



TTX1292 1/2" Torque Wrench set

1/2" drive torque wrench with built in angular gauge (40-210Nm/30-150ft/lb) in a TTX tool tray. Supplied in the unique Teng Tools TC tray for use on it's own or as part of the Teng Tools TC control system. (570x115x60mm, 1.6 kilos)



Torque wrench 1/2" drive angular torque wrench (40-200Nm, 30-150ft/lb)

TEX1238 Torque Wrench Set

1/2" drive and 3/8" drive angular gauge torque wrenches covering 20-210Nm (15-150 ft/lb) in total. Supplied in the unique Teng Tools drawer width TTX tray for use on it's own or as part of the Teng Tools TC control system. The tools are held in place using the Teng Tools three colour pre-cut EVA foam tool control system. (570x115x60mm, 2.77 kilos)

Torque wrench	3/8" drive	20-110Nm (15-81ft/lb)
	1/2" drive	40-210Nm (30-150 ft/lb)



1/2" Drive Torque Wrenches

Torque wrench according to ISO6789. With ratchet the torque wrench can be used for both tightening and final checking of the torque. Reversible with lever, but only for right hand action for torque checking. Equipped with angular gauge for after tightening. Graduated in Nm and ft/lbs. Lockable setting. Accuracy +/-4%. Satin finish.

Stock No.	Range Nm	Range ft/lb	Scale Nm	Scale ft/lb	L mm	W mm	H mm	Weight g
1292AG-EP	40-210	30-150	1.0	1.0	465	46.9	33.4	1340
1292AG-E4	70-350	50-250	5.0	5.0	632	47.1	37.1	2400



1/2" Drive Torque Wrenches →

1/2" Drive Torque Wrenches - CT Version

All Teng Tools torque wrenches are individually tested and certified at the time of manufacture. However, we are also able to offer torque wrenches with a certificate of tests conducted at the time of despatch from our central warehouse. All tests and equipment conform to the relevant ISO standards and individual torque wrenches will be checked and a certificate issued at the time the order is placed with us. The cost of this service is included in the price of CT type torque wrenches as shown in the table.

Stock No.	Range Nm	Range ft/lb	Scale Nm	Scale ft/lb	L mm	W mm	H mm	Weight g
1292AGP-CT	40-210	30-150	1.0	1.0	465	46.9	33.4	1340
1292AG4-CT	70-350	50-250	5.0	5.0	632	47.1	37.1	2400



1/2" Drive Torque Wrenches →

Bi Directional 1/2" Drive Torque Wrenches

Torque wrench according to ISO6789. Bi-directional torque wrench for left/right hand threads with push through square drive and flip reverse ratchet action for torque checking. Equipped with angular gauge for after tightening. Graduated in Nm and ft/lbs. Lockable setting. Accuracy +/-4%. Satin finish.

Stock No.	Range Nm	Range ft/lb	Scale Nm	Scale ft/lb	L mm	W mm	H mm	Weight g
1292AG-ER	40-200	30-150	1.0	1.0	465	49.6	33.4	1340
1292AG-E4R	70-350	50-250	5.0	5.0	632	47.1	37.1	2400



Bi Directional 1/2" Drive Torque Wrenches →

Bi Directional 1/2" Drive Torque Wrenches - CT Version **NEW!**

All Teng Tools torque wrenches are individually tested and certified at the time of manufacture. However, we are also able to offer torque wrenches with a certificate of tests conducted at the time of despatch from our central warehouse. All tests and equipment conform to the relevant ISO standards and individual torque wrenches will be checked and a certificate issued at the time the order is placed with us. The cost of this service is included in the price of CT type torque wrenches as shown in the table.

Stock No.	Range Nm	Range ft/lb	Scale Nm	Scale ft/lb	L mm	W mm	H mm	Weight g
1292AGR-CT	40-210	30-150	1.0	1.0	465	49.6	33.4	1340
1292AG4R-CT	70-350	50-250	5.0	5.0	632	47.1	37.1	2400



1/2" Drive Torque Wrenches - CT Version →

1/2" Drive Torque Plus Torque Wrenches **NEW!**

Industrial grade torque wrenches designed and manufactured to exceed DIN3122 with an accuracy of +/- 4% maximum. Each torque wrench is supplied with an individual, fully traceable calibration certificate from the date of manufacture. A 72 teeth ratchet mechanism allows for greater access even in confined spaces and incorporates a quick release mechanism and twist reverse for changing direction but torque is only measurable in the conventional right hand direction. The scale is an easy to read window style Nm scale while the handle has an ergonomically designed bi-material grip for added comfort and a hanging facility that can also be used in conjunction with a Teng Tools safety wire for added security when working at heights. The Plus torque wrenches also feature a safety locking button to enable reliable locking of the torque setting.

Stock No.	Range Nm	Scale Nm	L mm	W mm	H mm	Weight g
1292P100	20-100	0.5	410	36	36	965
1292P200	40-200	1.0	490	42	44	1,465
1292P320	60-320	2.0	560	42	44	1,645



1/2" Drive Torque Plus Torque Wrenches - CT version **NEW!**

All Teng Tools torque wrenches are individually tested and certified at the time of manufacture. However, we are also able to offer torque wrenches with a certificate of tests conducted at the time of despatch from our central warehouse. All tests and equipment conform to the relevant ISO standards and individual torque wrenches will be checked and a certificate issued at the time the order is placed with us. The cost of this service is included in the price of CT type torque wrenches as shown in the table.

Stock No.	Range Nm	Scale Nm	L mm	W mm	H mm	Weight g
1292P100-CT	20-100	0.5	410	36	36	965
1292P200-CT	40-200	1.0	490	42	44	1,465
1292P320-CT	60-320	2.0	560	42	44	1,645



TTPSTQ04 Preset Torque Wrench set

4 piece 1/2" drive preset torque wrenches, set to 90, 110, 120 and 140Nm. Accuracy to +/- 4%, with rubber handle and supplied with a separate wall rack. ISO6789. Supplied in the unique Teng Tools tray for use on it's own or as part of the Teng Tools TC control system. (570x262x73mm, 5.80 kilos)

1/2"drive preset torque wrenches 90, 110, 120, 140Nm

Preset 1/2" Drive Torque Wrenches

Pre set torque wrenches according to ISO6789. For continued use up to 5000 clicks. Equipped with angular gauge for after tightening. Settings in Nm. Lockable setting. Accuracy +/- 4%. Satin finish.

1/2" Drive Torque Wrenches →

Stock No.	Preset Torque Nm	L mm	W mm	H mm	Weight g
1292AG-090	90	513	46.9	33.4	1400
1292AG-110	110	513	46.9	33.4	1400
1292AG-120	120	513	46.9	33.4	1400
1292AG-140	140	513	46.9	33.4	1400



1292D200 1/2" Drive Electronic/Digital Torque Wrench

An easy to use electronic, digital torque wrench. 9 separate torque settings with individual torque, percentage tolerance and unit settings to enable the torque wrench to be pre-programmed for different torque tolerances before use. An audio visual warning system alerts the user with an orange light before, a green light on and a red light after the target torque is reached. Accuracy +/- 1%, reading in Nm, ft/lb, in/lb and kg/m. Quick release mechanism on the square drive and bi-directional torque facility. Each torque setting has an individual recallable memory storing the last nine settings. Uses standard AA batteries and supplied in a storage case for protection and convenient storage when not in use. The torque wrench meets or exceeds the demands according to ISO6789:2003 and is supplied with a certificate of calibration at the time of production.

Stock No.	Range Nm	Range ft/lb	Scale Nm	Scale ft/lb	L mm	W mm	H mm	Weight g
1292D200	20-200	30-150	0.1	0.1	548	42.5	46.5	1200



1292D200-CT 1/2" Drive Electronic/Digital Torque Wrench - CT version

An easy to use electronic, digital torque wrench. 9 separate torque settings with individual torque, percentage tolerance and unit settings to enable the torque wrench to be pre-programmed for different torque tolerances before use. An audio visual warning system alerts the user with an orange light before, a green light on and a red light after the target torque is reached. Accuracy +/- 1%, reading in Nm, ft/lb, in/lb and kg/m. Quick release mechanism on the square drive and bi-directional torque facility. Each torque setting has an individual recallable memory storing the last nine settings. Uses standard AA batteries and supplied in a storage case for protection and convenient storage when not in use. The torque wrench meets or exceeds the demands according to ISO6789:2003 and is supplied with a certificate of calibration issued at the time the order is placed with us.

Stock No.	Range Nm	Range ft/lb	Scale Nm	Scale ft/lb	L mm	W mm	H mm	Weight g
1292D200-CT	20-200	30-150	0.1	0.1	548	42.5	46.5	1200



3/4" Drive Torque Wrenches

Torque wrench according to ISO6789. With ratchet the torque wrench can be used for both tightening, and final checking of the torque. Reversible with lever, but only for right hand action for torque checking. Equipped with angular gauge for after tightening. Graduated in Nm and ft/lbs. Lockable setting. Accuracy +/-4%. Satin finish.

3/4" Drive Torque Wrenches →

Stock No.	Range Nm	Range ft/lb	Scale Nm	Scale ft/lb	L mm	W mm	H mm	Weight g
3492AG-E	90-450	70-350	5.0	5.0	850	72.5	53.5	3840
3492AG-E1	140-700	100-500	2.5	2.5	1065	72.5	53.5	6160
3492AG-E2	200-980	140-700	2.5	2.5	1213	72.5	53.5	6160



3/4" Drive Torque Wrenches - CT Version

All Teng Tools torque wrenches are individually tested and certified at the time of manufacture. However, we are also able to offer torque wrenches with a certificate of tests conducted at the time of despatch from our central warehouse. All tests and equipment conform to the relevant ISO standards and individual torque wrenches will be checked and a certificate issued at the time the order is placed with us. The cost of this service is included in the price of CT type torque wrenches as shown in the table.

Stock No.	Range Nm	Range ft/lb	Scale Nm	Scale ft/lb	L mm	W mm	H mm	Weight g
3492AG-CT	90-450	70-350	5.0	5.0	850	72.5	53.5	3840
3492AG1-CT	140-700	100-500	2.5	2.5	1065	72.5	53.5	6160
3492AG2-CT	200-980	140-700	2.5	2.5	1213	72.5	53.5	6160



3/4" Drive Torque Wrenches - CT Version →

3/4" Drive Torque Plus Torque Wrenches

Industrial grade torque wrenches designed and manufactured to exceed ISO6789 with an accuracy of +/- 4% maximum. Each torque wrench is supplied with an individual, fully traceable calibration certificate from the date of manufacture. A 72 teeth ratchet mechanism allows for greater access even in confined spaces and incorporates a quick release mechanism and twist reverse for changing direction but torque is only measurable in the conventional right hand direction. The scale is an easy to read window style Nm scale while the handle has an ergonomically designed bi-material grip for added comfort and a hanging facility that can also be used in conjunction with a Teng Tools safety wire for added security when working at heights. The Plus torque wrenches also feature a safety locking button to enable reliable locking of the torque setting.

NEW!

Stock No.	Range Nm	Scale Nm	L mm	W mm	H mm	Weight g
3492P500	100-500	2.5	790	68	62	3,100



3/4" Drive Torque Plus Torque Wrenches – CT version

All Teng Tools torque wrenches are individually tested and certified at the time of manufacture. However, we are also able to offer torque wrenches with a certificate of tests conducted at the time of despatch from our central warehouse. All tests and equipment conform to the relevant ISO standards and individual torque wrenches will be checked and a certificate issued at the time the order is placed with us. The cost of this service is included in the price of CT type torque wrenches as shown in the table.

Stock No.	Range Nm	Scale Nm	L mm	W mm	H mm	Weight g
3492P500-CT	100-500	2.5	790	68	62	3,100



3492AG-ER Bi Directional 3/4" Drive Torque Wrenches

Torque wrench according to ISO6789. Bi-directional torque wrench for left/right hand threads with push through square drive and flip reverse ratchet action for torque checking. Equipped with angular gauge for after tightening. Graduated in Nm and ft/lbs. Lockable setting. Accuracy +/-4%. Satin finish.

Range	Range ft/lb	Scale Nm	Scale ft/lb	L mm	W mm	H mm	Weight g
90-450	70-350	5.0	5.0	850	72.5	53.5	3840



3492AGR-CT Bi Directional 3/4" Drive Torque Wrenches – CT version

All Teng Tools torque wrenches are individually tested and certified at the time of manufacture. However, we are also able to offer torque wrenches with a certificate of tests conducted at the time of despatch from our central warehouse. All tests and equipment conform to the relevant ISO standards and individual torque wrenches will be checked and a certificate issued at the time the order is placed with us. The cost of this service is included in the price of CT type torque wrenches as shown in the table.

Range	Range ft/lb	Scale Nm	Scale ft/lb	L mm	W mm	H mm	Weight g
90-450	70-350	5.0	5.0	850	72.5	53.5	3840



Service kits

Service kits for torque wrenches.

Stock No.		
1492AGERK	1/4"	Service kit for 1492AG-E
3892AG1RK	3/8"	Service kit for 3892AG-E1
3892AG3RK	3/8"	Service kit for 3892AG-E3
1292AGERK	1/2"	Service kit for 1292AG-E, 1292AG-EP and pre set range of torque wrenches
1292AGERRK	1/2"	Service kit for 1292AG-ER
1292AG4RK	1/2"	Service kit for 1292AG-E4
1292AG4RRK	1/2"	Service kit for 1292AG-E4R
3492AGERRK	3/4"	Service kit for 3492AG-ER
3492AGERK	3/4"	Service kit for 3492AG-E, 3492AG-E1 +3492AG-E2

ACD01

Torque Wrenches for Air Conditioning Engineers

A set of four pre-set open jaw torque wrenches especially developed for use by air conditioning engineers. Supplied in a handy carrying case. ISO6789-1992. Accuracy +/-4%. (overall weight 1.40 kilos). Also available individually.

	Spanner size	Preset torque
Torque wrenches	17	18
	22	42
	26	55
	29	65



Torque Wrenches for Air Conditioning Engineers

Pre-set open jaw torque wrenches especially developed for use by air conditioning engineers. ISO6789-1992. Accuracy +/-4%.

Stock No.	Spanner size mm	Preset torque Nm	Weight g
TQS018	17	18	396
TQS042	22	42	428
TQS055	26	55	546
TQS065	29	65	576



TTAG Angular Gauge

For use with torque wrenches that do not have an in-built angular gauge. Enables the reading of the number of degrees of "after tightening" when tightening on certain applications where the angle needs to be measured (stretch bolts, etc). A static read off point, fixing magnet and a pair of angle scales make it possible to take a reading in most situations.



TTXMP12 Torque Multiplier set

A 1292AG-EP 1/2" drive tested and certified torque wrench 200Nm together with an MP1400 torque multiplier that converts the torque at a ratio of 3:1 up to a maximum torque capacity of 1,500Nm with a 3/4" male square drive. Supplied in the unique Teng Tools TTX tray for use on it's own or as part of the Teng Tools TC control system. (570x115x60mm, 4.0 kilos)

Torque wrench	1/2" drive angular gauge covering 40 to 210Nm (1292AG-EP)
Torque multiplier	1/2" F:3/4" M torque multiplier (3 to 1 ratio) and maximum torque capacity 1,500Nm (MP1400)



TEXMP12 Torque Multiplier Set **NEW!**

A 1292AG-EP 1/2" drive tested and certified 200Nm torque wrench together with an MP1400 torque multiplier that converts the torque at a ratio of 3:1 up to a maximum capacity of 1500Nm with a 3/4" male square drive. Supplied in the unique Teng Tools drawer width TTX tray for use on it's own or as part of the Teng Tools TC control system. The tools are held in place using the Teng Tools three colour pre-cut EVA foam tool control system. (570x115x60mm, 4.6 kilos)

Torque wrench	1/2" drive angular gauge covering 40 to 210NM (1292AG-EP)
Torque multiplier	1/2" F:3/4" M torque multiplier (3 to 1 ratio) and maximum torque capacity



Torque Wrenches

Torque Multipliers (1:3 ratio)

Designed for tightening and loosening nuts and bolts where extra torque is required. Use together with a torque wrench and impact sockets to convert torque at a ratio of 3 to 1.

Stock No		MP1400	MP2700
Max tightening torque	Nm	1,500	3,000
Max tightening torque	lb/ft	1,100	2,200
Torque multiplication		x 3	x 3
External diameter	mm	69	92
Input drive		½"	¾"
Output drive		¾"	1"
Weight	kilos	2.28	4.78

Support leg	Stock No	MPSL01	MPSL02
Service kit	Stock No	MP1400RK-1	MP2700RK-1
	Price	£239.00	£259.00



Torque Multipliers (1:9 ratio)

Designed for tightening and loosening nuts and bolts where extra torque is required. Use together with a torque wrench and impact sockets to convert torque at a ratio of 9 to 1.

Stock No		MP91500
Max tightening torque	Nm	1,500
Max tightening torque	lb/ft	1,100
Torque multiplication		x 9
Input drive		½"
Output drive		¾"
Weight	kilos	3.18

Service kit	Stock No	MP91500RK
-------------	----------	-----------



Torque Wrenches → Insert tools with 9 x 12mm rectangular fitting

3892CQ100R Insert Tool

Insert 3/8" drive ratchet adaptor with 45 teeth. With 9 x 12mm rectangular fitting. Use with regular or deep 3/8" drive sockets and socket accessories. Satin finish.

W	H	L	L1	Weight
mm	mm	mm	mm	kilos
35	36.5	36.3	20.0	0.15



Torque Wrenches

Insert Tools - Open ended spanners

Insert tool open ended spanners with 9 x 12mm rectangular fitting. Satin finish.

Stock no.	Size	Fitting mm	W mm	H mm	L mm	L1 mm	Weight g
690510	10	9 x 12	30	15	39	18	42
690511	11	9 x 12	30	15	39	18	43
690512	12	9 x 12	30	16	40	18	48
690513	13	9 x 12	30	16	42	20	52
690514	14	9 x 12	35	17	42	20	59
690515	15	9 x 12	35	17	43	20	59
690516	16	9 x 12	38	18	43	20	67
690517	17	9 x 12	38	18	44	20	67
690518	18	9 x 12	42	18	46	22	75
690519	19	9 x 12	42	18	46	22	75

Insert Tools - Open ended spanners →

Insert Tools - Ring spanners

Insert tool ring spanners with 9 x 12mm rectangular fitting. Satin finish.

Stock no.	Size	Fitting mm	W mm	H mm	L mm	L1 mm	Weight g
690710	10	9 x 12	26.5	16	45	18	52
690711	11	9 x 12	26.5	16	45	18	50
690712	12	9 x 12	26.7	16	46	18	48
690713	13	9 x 12	27.2	16	49	20	60
690714	14	9 x 12	27.0	18	50	20	64
690715	15	9 x 12	27.0	18	50	20	64
690716	16	9 x 12	27.0	18	50	20	62
690717	17	9 x 12	28.6	18	54	22	74
690718	18	9 x 12	28.6	18	54	22	74
690719	19	9 x 12	28.6	18	54	22	68

Insert Tools - Ring spanners →

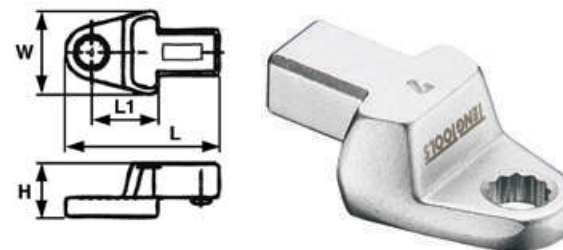
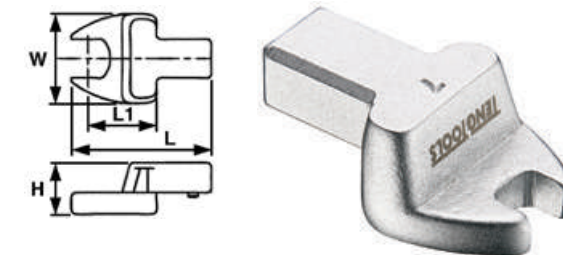

Torque Wrenches → Insert tools with 14 x 18mm rectangular fitting

Insert Tools - Open ended spanners

Insert tool open ended spanners with 14 x 18mm rectangular fitting. Satin finish.

Stock no.	Size	Fitting mm	W mm	H mm	L mm	L1 mm	Weight g
690613	13	14 x 18	35	21	63	32	148
690614	14	14 x 18	35	22	63	32	154
690615	15	14 x 18	35	23	64	32	154
690616	16	14 x 18	38	23	64	32	173
690617	17	14 x 18	38	23	64	32	173
690618	18	14 x 18	42	24	65	32	192
690619	19	14 x 18	42	25	65	32	193
690621	21	14 x 18	50	25	66	32	217
690622	22	14 x 18	53	26	66	32	222
690624	24	14 x 18	53	26	67	32	225
690626	26	14 x 18	60	27	70	33	273
690627	27	14 x 18	60	27	70	34	281
690629	29	14 x 18	66	28	74	36	312
690630	30	14 x 18	66	28	74	36	312
690632	32	14 x 18	66	29	77	38	322
690634	34	14 x 18	73	29	82	43	345
690636	36	14 x 18	73	29	82	42	368
690638	38	14 x 18	73	29	82	41	366
690640	40	14 x 18	82	29	83	42	383
690641	41	14 x 18	82	29	84	42	400
690642	42	14 x 18	82	29	83	42	410
690644	44	14 x 18	91	29	86	41	423
690646	46	14 x 18	91	29	86	43	436

Insert Tools - Open ended spanners →

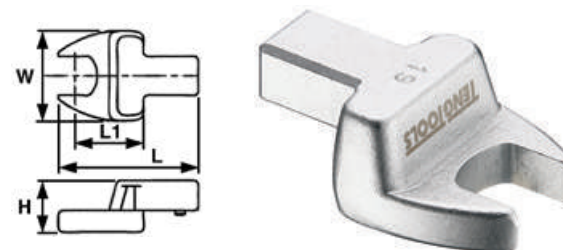

Torque Wrenches

Insert Tools - Ring spanners

Insert tool ring spanners with 14 x 18mm rectangular fitting for use with TQWC200 or TQWC500 torque wrenches. Satin finish.

Stock no.	Size	Fitting mm	W mm	H mm	L mm	L1 mm	Weight g
690813	13	14 x 18	38.0	22	72	32	200
690814	14	14 x 18	38.0	22	72	32	200
690815	15	14 x 18	38.0	22	73	32	194
690816	16	14 x 18	38.0	24	73	32	204
690817	17	14 x 18	38.0	24	73	32	194
690818	18	14 x 18	44.0	24	75	32	234
690819	19	14 x 18	44.0	24	75	32	230
690821	21	14 x 18	41.0	26	76	32	236
690822	22	14 x 18	42.0	25	77	32	250
690824	24	14 x 18	42.0	26	78	32	254
690826	26	14 x 18	42.0	26	78	32	240
690827	27	14 x 18	43.4	27	82	34	280
690829	29	14 x 18	43.3	28	85	36	306
690830	30	14 x 18	47.3	28	87	36	328
690832	32	14 x 18	47.3	29	87	36	312
690834	34	14 x 18	50.0	29	90	38	324
690836	36	14 x 18	52.0	29	91	38	316
690838	38	14 x 18	54.6	31	94	40	342
690840	40	14 x 18	54.6	30	93	40	367
690841	41	14 x 18	60.0	32	99	42	376
690842	42	14 x 18	60.0	32	99	42	376
690844	44	14 x 18	60.0	31	99	44	386
690846	46	14 x 18	64.8	32	103	42	396

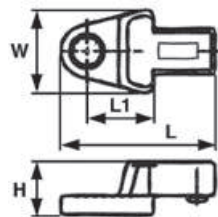

Insert Tools - Ring spanners →

DO'S AND DONT'S OF TORQUE

- ✔ **The right drive**
 Use the correct drive of torque wrench to suit the size of fastening you need to turn and how much torque you need to apply. The larger the drive the more torque can be applied.
- ✔ **Keep it clean and dry**
 After use always check the tools are clean and dry before putting them away, this will help to avoid problems such as corrosion and moving parts seizing or becoming tight.
- ✔ **Store it properly**
 After use return the torque wrench setting to zero and store the tool in it's original case or a suitable case that will give adequate protection
- ✔ **Check it regularly**
 All torque wrenches need to be checked periodically and sometimes adjusted.
- ✔ **Be careful**
 Torque wrenches are a measuring instrument and need to be treated with care – if you drop it you should get the calibration checked before using the torque wrench again
- ✘ **Do not use scaffolding poles or similar**
 If the fastening will not turn with the tools you are using you need to use a more powerful tool such as a larger tool or even an impact power tool. Do not use bars to increase the leverage – it is dangerous and can break the tool.
- ✘ **Do not use a vehicle to turn the nut**
 Do not fix a torque wrench on to a fastening and then drive the vehicle to force it to turn – needless to say it is dangerous and can break the tools.
- ✘ **Do not use it as a breaker bar**
 Torque wrenches are for measuring and should not be used as a breaker bar to shift stubborn fastenings.

EVERY SECOND COUNTS

POLE POSITION ACCORDING TO TENG



Get organised™





SCREWDRIVERS

Teng Tools screwdrivers

Screwdrivers in the Teng Tools range have steel alloy TT-MV plus blades. This makes the shaft harder, yet also more flexible. The bi-material handle is designed to suit either your need for power transfer or speed. The range includes more than 100 different screwdrivers and also a number of screwdriver sets.

Range

- Complete range of screwdrivers that covers most needs of a professional user. More than 100 different screwdrivers are included and are available with slotted, PH, PZ, HEX, TX, TPX as well as square tips, both individually and in a number of sets.
- Screwdrivers with a power through blade and striking head, extra-long screwdrivers with PH and slotted tips.
- Flared or parallel phosphate tips to suit different applications.
- Select the handle for power, size L (triangular shaped) or speed, size M (round) in the most popular sizes: PH2, PZ 2 and slotted.

SCREWDRIVERS



Handle

- The handle has a unique, ergonomically designed two component grip with a greater volume to give better support, increased comfort and improved power transfer.
- The handle is moulded around the blade, this ensures that all Teng Tools screwdrivers are completely straight and permits much larger wings on the blade, which in turn allows a much greater torque.
- Hole in the handle for tool-securing when working at height, for hanging or for use as a T-handle.

Blade

- steel alloy blade, TT-MV Plus, gives 20 % greater capacity than standard screwdrivers. Hardness is 59-61 HRC at the same time the material is more flexible.

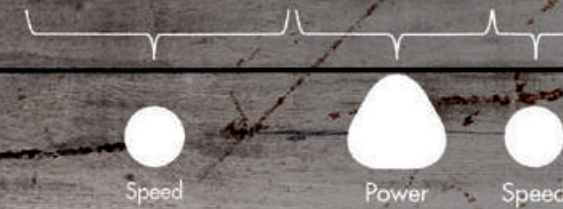
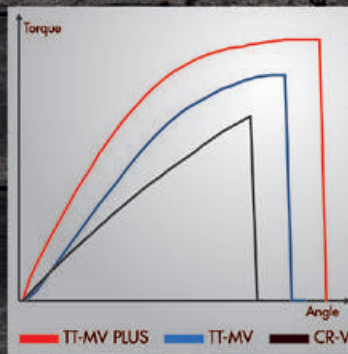

The handle on the larger sizes has three different zones: speed, power, speed. The speed zones are round and the power zone is triangular shaped.



The smaller handles, where less force is required, have a round profile to make it easier to work quickly.

Get organised™



MD9053N 53 Piece screwdriver set

A comprehensive screwdriver set including 19 screwdrivers and a ratcheting bits driver together with a selection of screwdriver bits. Features include screwdrivers with ergonomically designed bi-material handles with hanging hole and T drive facility for added torque and comfort. Supplied in a handy carrying case. All Teng Tools screwdrivers are designed to have a hole in the handle which can also be used for securing the tool with a fall protection wire if needed.

Screwdrivers	Flat type	3.0x75mm, 3.0x100mm, 4.0x100mm, 5.5x75mm, 5.5x150mm, 6.0x38mm, 6.5x100mm, 6.5x150mm, 8.0x150mm, 10.0x200mm
	PH type	PH1x75mm, PH2x38mm, PH2x100mm, PH3x150mm
	PZ type	PZ0x75mm, PZ1x75mm, PZ2x38mm, PZ2x100mm, PZ3x150mm
Accessories		Ratcheting bits driver with 1.2x5mm and 1.4x7mm flat bits, PH1, PH2, PZ1 and PZ2 bits
¼" hex 25mm screwdriver bits	PZ type	0
	TX type	TX6, TX7, TX8, TX9, TX10, TX15 (x2), TX20 (x2) TX25 (x2), TX27, TX30, TX40
	TPX type	TPX20, TPX25, TPX30
	Square	1, 2, 3
	Hexagon	2, 3, 4, 5, 6, 8mm



MD910N 10 Piece screwdriver set

Set of 10 screwdrivers for slotted heads as well as Phillips and Pozi drive heads. Features include TT-MV PLUS steel blades and ergonomically designed bi-material handles with hanging hole and T drive facility for added torque and comfort. Supplied in a handy carrying case. All Teng Tools screwdrivers are designed to have a hole in the handle which can also be used for securing the tool with a fall protection wire if needed.

Screwdrivers	Flat type	3.0x100mm, 5.5x75mm, 5.5x150mm, 6.5x150mm
	1,000 volt flat	3.0x100mm
	PH type	PH0x75mm, PH1x75mm, PH2x100mm
	PZ type	PZ1x75mm, PZ2x100mm

MD912N 12 Piece screwdriver set

Set of 12 screwdrivers for slotted heads as well as Phillips and Pozi drive heads. Features include TT-MV PLUS steel blades and ergonomically designed bi-material handles with hanging hole and T drive facility for added torque and comfort. Supplied in a full colour display box with PS tray. All Teng Tools screwdrivers are designed to have a hole in the handle which can also be used for securing the tool with a fall protection wire if needed.

Screwdrivers	Flat type	2.5x75mm, 3.5x100mm, 4x150mm, 5.5x150mm, 6.5x150mm, 10x200mm
	PH type	PH0x75mm, PH1x75mm, PH2x100mm, PH2x200mm
	PZ type	PZ1x75mm, PZ2x100mm



MD912N1 12 Piece screwdriver set

Set of 12 screwdrivers for slotted heads as well as Phillips, Pozi and TX drive heads, including the most popular 1,000 volt insulated screwdrivers (produced and tested according to the EN60900 standard. Approved for working up to 1,000 volt AC). Features include TT-MV PLUS steel blades and ergonomically designed bi-material handles with hanging hole and T drive facility for added torque and comfort. Supplied in a full colour display box with PS tray. All Teng Tools screwdrivers are designed to have a hole in the handle which can also be used for securing the tool with a fall protection wire if needed.

Screwdrivers	Flat type	3.0x75mm, 3.5x100mm, 5.5x150mm, 2.5x75mm insulated, 3.0x100mm insulated.
	PH type	PH1x75mm, PH2x100mm, PH1x80mm insulated
	PZ type	PZ2x100mm
	TX type	TX20x100mm, TX25x100mm, TX30x100mm



MD906N 6 Piece screwdriver set

Set of 6 screwdrivers for slotted heads as well as Phillips and Pozi drive heads. Features include TT-MV PLUS steel blades and ergonomically designed bi-material handles with hanging hole and T drive facility for added torque and comfort. Supplied in a full colour display box with PS tray. All Teng Tools screwdrivers are designed to have a hole in the handle which can also be used for securing the tool with a fall protection wire if needed.

Screwdrivers	Flat type	3 x 75mm, 5.5 x 150mm
	PH type	PH1 x 75mm, PH2 x 100mm
	PZ type	PZ1 x 75mm, PZ2 x 100mm



MD906N2 6 Piece screwdriver set

Set of 6 screwdrivers for Pozi and TX drive heads. Features include TT-MV PLUS steel blades and ergonomically designed bi-material handles with hanging hole and T drive facility for added torque and comfort. Supplied in a full colour display box with PS tray. All Teng Tools screwdrivers are designed to have a hole in the handle which can also be used for securing the tool with a fall protection wire if needed.

Screwdrivers	PZ type	PZ1 x 75mm, PZ2 x 100mm
	TX type	TX10 x 100mm, TX15 x 100mm, TX20 x 100mm, TX25 x 100mm



MD906N3 6 Piece screwdriver set

Set of 6 screwdrivers for slotted heads and Phillips type heads. Features include TT-MV PLUS steel blades and ergonomically designed bi-material handles with hanging hole and T drive facility for added torque and comfort. Supplied in a full colour display box with PS tray. All Teng Tools screwdrivers are designed to have a hole in the handle which can also be used for securing the tool with a fall protection wire if needed.

Screwdrivers	Flat type	3 x 75mm, 4 x 100mm, 5.5 x 75mm, 6.5 x 100mm
	PH type	PH1 x 75mm, PH2 x 100mm



MD906N4 6 Piece screwdriver set

Set of 6 screwdrivers for slotted heads and Pozi type heads. Features include TT-MV PLUS steel blades and ergonomically designed bi-material handles with hanging hole and T drive facility for added torque and comfort. Supplied in a full colour display box with PS tray. All Teng Tools screwdrivers are designed to have a hole in the handle which can also be used for securing the tool with a fall protection wire if needed.

Screwdrivers	Flat type	3 x 75mm, 4 x 100mm, 5.5 x 75mm, 6.5 x 100mm
	PZ type	PZ1 x 75mm, PZ2 x 100mm



MDMC702N 2 Piece screwdriver set with pocket clips

A flat blade and PH type screwdriver together as a set. TT-MV PLUS steel, black tip, ergonomically designed bi-material handles with pocket clip. All Teng Tools screwdrivers are designed to have a hole in the handle which can also be used for securing the tool with a fall protection wire if needed.

Screwdriver	Flat type	3.0 x 50mm
	PH type	PH1 x 50mm



TT917N 7 Piece Screwdriver set

7 piece screwdriver set including flat as well as PH and PZ types. Features include TT-MV PLUS steel blades and ergonomically designed bi-material handles with hanging hole and T drive facility for added torque and comfort. Supplied in the unique Teng Tools TC tray with removable lid and dove tail joints for use on it's own or as part of the Teng Tools TC control system. All Teng Tools screwdrivers are designed to have a hole in the handle which can also be used for securing the tool with a fall protection wire if needed. (265x142x50mm, 0.7 Kilos)

Screwdrivers	Flat type	3x75mm, 5.5x75mm, 6.5x100mm
Screwdrivers	PH type	PH0x75mm, PH1x75mm, PH2x100mm
Screwdrivers	PZ type	PZ2x100mm



Screwdrivers

TTX918N 8 Piece Screwdriver Set

8 piece screwdriver set including flat, regular and PH types with ergonomically designed bi-material handle with hanging hole. Supplied in the unique Teng Tools TTX tray for use on it's own or as part of the Teng Tools TC control system. Supplied in a handy carrying case. All Teng Tools screwdrivers are designed to have a hole in the handle which can also be used for securing the tool with a fall protection wire if needed. (570x115x40mm, 1.0 kilos)



Screwdrivers	Flat type	6.5 x 38mm stubby, 3 x 100mm, 6.5 x 100mm, 10 x 200mm, 5.5 x 150mm, 8 x 150mm
Screwdrivers	PH type	PH2 x 38mm stubby, PH3 x 150mm

TTD914N 14 Piece Screwdriver set

14 piece screwdriver set including flat as well as PH and PZ types. Features include TT-MV PLUS steel blades and ergonomically designed bi-material handles with hanging hole and T drive facility for added torque and comfort. Supplied in the unique Teng Tools double TC tray with removable lid and dove tail joints for use on it's own or as part of the Teng Tools TC control system. All Teng Tools screwdrivers are designed to have a hole in the handle which can also be used for securing the tool with a fall protection wire if needed. (265x248x50mm, 1.2 kilos)



Screwdrivers	Flat type	3x75mm, 3.5x100mm, 5.5x75mm, 5.5x125mm, 6.5x38mm stubby, 6.5x100mm
Screwdrivers	PH type	PH0x75mm, PH1x75mm, PH2x38mm stubby, PH2x100mm
Screwdrivers	PZ type	PZ0x75mm, PZ1x75mm, PZ2x38mm stubby, PZ2x100mm

TED911N Screwdriver Set

11 piece screwdriver set. Supplied in the unique Teng Tools double width TC tray with removable lid and dove tail joints for use on it's own or as part of the Teng Tools TC control system. The tools are held in place using the Teng Tools three colour pre-cut EVA foam tool control system. All Teng Tools screwdrivers are designed to have a hole in the handle which can also be used for securing the tool with a fall protection wire if needed. (265x284x50mm, 1.22 kilos)



Screwdrivers	flat type	round shaft	3.5x100, 5.5x75mm, 6.5x38mm stubby
	flat type	hexagon shaft	5.5x125, 6.5x100mm
Screwdrivers	PH type	round shaft	PH0x75, PH1x75, PH2x38mm stubby
	PH type	hexagon shaft	PH2x100mm
Screwdrivers	PZ type	round shaft	PZ1x75mm
	PZ type	hexagon shaft	PZ2x100mm

TEX915N Screwdriver Set

5 piece screwdriver set. Supplied in the unique Teng Tools drawer width TTX tray for use on it's own or as part of the Teng Tools TC control system. The tools are held in place using the Teng Tools three colour pre-cut EVA foam tool control system. All Teng Tools screwdrivers are designed to have a hole in the handle which can also be used for securing the tool with a fall protection wire if needed. (570x115x40mm, 1.22 kilos)

Screwdrivers	Flat type	5.5x150, 6.5x150, 8.0x150, 10.0x200mm
Screwdrivers	PH type	PH3x150mm



Screwdrivers

WRMD10N Screwdriver Set

10 piece screwdriver set. Screwdrivers have bi-material TPR grip for added comfort and grip. Complete with a wall rack for fixing to the wall or a work bench. All Teng Tools screwdrivers are designed to have a hole in the handle which can also be used for securing the tool with a fall protection wire if needed.



Screwdrivers	Flat type	0.5x3.0x100, 1.0x5.5x75, 1.0x5.5x150, 1.2x6.5x150, 1.2x8.0x150mm
	PH	PH0x75, PH1x75, PH2x100mm
	PZ	PZ1x75, PZ2x100mm

TTEM122N Screwdriver Set

Set containing a comprehensive range of Mega Drive screwdrivers and bits. Supplied in the Teng Tools three colour pre-cut EVA foam tool control system. All Teng Tools screwdrivers are designed to have a hole in the handle which can also be used for securing the tool with a fall protection wire if needed. (570x375x75mm, 3.13 kilos)



Screwdrivers	Flat type	2.5x75mm, 3.5x75mm, 3.0x100mm, 4.0x100mm, 5.5x75mm, 5.5x150mm, 6.5x38mm, 6.5x100mm, 6.5x150mm, 8.0x150mm, 10.0x200mm
Screwdrivers	PH type	PH0x75mm, PH1x38mm, PH1x75mm, PH2x38mm, PH2x100mm, PH3x150mm, PH4x200mm
Screwdrivers	PZ type	PZ0x75mm, PZ1x38mm, PZ1x100mm, PZ2x38mm, PZ2x100mm, PZ2x150mm, PZ3x150mm
Accessories	1/4" hex drive	6 in 1 ratcheting bits driver set, bit holders for 25mm bits
25mm hex bits	1/4" hex drive	0.6x3.5mm, 0.6x4.5mm, 0.8x4.0mm (x2), 0.8x5.5mm (x2), 1.2x6.5mm, 1.6x8.0mm flat, PH1 (x3), PH2 (x3), PH3 (x3), PZ1 (x3), PZ2 (x3), PZ3 (x3), TX6, 7, 8, 9, 10, 15, 20 (x3), 25 (x3), 27, 30, 40, 2, 3, 4, 5, 6, 8mm hex, ROB1, ROB2, ROB3, GR2 (x3), TPX10, 15, 20 (x2), 25 (x2), 27, 30, 40
50mm hex bits	1/4" hex drive	0.6x3.5mm, 0.8x4.0mm, 0.8x5.5mm, 1.0x5.5mm, 1.2x6.5mm flat (3 of each), 4, 5, 6, 8mm (3 of each), PH1, PH2 (x2), PH3, PZ1, PZ2 (x2), PZ3, TX8, 10 (x2), 15, 20 (x2), 25 (x2), 27, 30.

TTEM98N 98 piece screwdriver and bits driver set

Set containing a wide range of screwdrivers covering all types and including a range of 1,000 volt insulated screwdrivers (produced and tested according to the EN60900 standard. Approved for working up to 1,000 volt AC). Supplied in the Teng Tools three colour pre-cut EVA foam tool control system. All Teng Tools screwdrivers are designed to have a hole in the handle which can also be used for securing the tool with a fall protection wire if needed. (570x375x50mm, 2.83 kilos)



Screwdrivers	TX type	TX8x75, TX9x75mm
Screwdrivers	TPX type	TPX10x100, TPX15x100, TPX20x100, TPX25x100, TPX30x100mm
Power thru screwdrivers	Flat type	6.5x100, 8x150, 10x200mm
Power thru screwdrivers	PH type	PH2x100, PH3x150mm
1,000 volt screwdrivers	Flat type	2.5x75, 4x100, 5.5x125mm
1,000 volt screwdrivers	PH type	PH0x60, PH1x8, PH2x100mm
1,000 volt screwdrivers	PZ type	PZ2x100mm
Mini screwdrivers	Flat type	2.0x40, 2.5x40, 3.0x40mm
Mini screwdrivers	PH type	PH00x40, PH0x40, PH1x40mm
Mini screwdrivers	TX type	TX6, TX7, TX8, TX9, TX10, TX15
1/4" hex 25mm screwdriver bits	Flat type	0.6x3.5, 0.6x4.5, 0.8x4.0(2pieces), 0.8x5.5, 1.0x5.5(2 pieces), 1.2x6.5, 1.6x8.0mm
1/4" hex 25mm screwdriver bits	GR type	PH2 (3 pieces)
1/4" hex 25mm screwdriver bits	Hex type	2, 3, 4, 5, 6, 8mm
1/4" hex 25mm screwdriver bits	PH type	PH1 (3 pieces), PH2 (3 pieces), PH3 (3 pieces),
1/4" hex 25mm screwdriver bits	PZ type	PZ1 (3 pieces), PZ2 (3 pieces), PZ3 (4 pieces)
1/4" hex 25mm screwdriver bits	ROB type	1,2,3 square
1/4" hex 25mm screwdriver bits	TX type	TX6, TX7, TX8, TX10, TX15, TX20 (3 pieces), TX25 (3 pieces), TX27, TX30, TX40
1/4" hex 25mm screwdriver bits	TPX type	TPX10, TPX15, TPX20 (2 pieces), TPX25 (2 pieces), TPX27, TPX30, TPX40
Ratcheting bits driver		Reversible for use with 1/4" hexagon drive bits. Supplied with 6 assorted bits stored in slide out holder in the handle
Accessories		Magnetic charger and discharger for magnetising and/or demagnetising screwdriver tips, "bullet holders" for bits
Accessories	1/4" drive	1/4" M:1/4" hexagon adaptor, coupler adaptor

TTMD12D Screwdriver set

Set of 12 interchangeable screwdriver blades including TX, hex as well as Phillips and Pozidrive heads. With chrome vanadium steel blades. Supplied in the unique Teng Tools TC tray with removable lid and dove tail joints for use on it's own or as part of the Teng Tools TC control system. All Teng Tools screwdrivers are designed to have a hole in the handle which can also be used for securing the tool with a fall protection wire if needed. (265x142x50mm, 0.6 kilos)

Screwdrivers	Changeable handle for 1/4" shank
Screwdrivers TX Type	TX10xTX15, TX20xTX25, TX30xTX40
Screwdrivers Hex type	Hex ball 3.0 x Hex 3.0mm, Hex ball 4.0 x Hex 4.0mm, Hex ball 5.0 x Hex 5.0mm, Hex ball 6.0 x Hex 6.0mm
Screwdrivers PH type	PH1 x PH2, PH3 x Flat 6.5mm
Screwdrivers Flat type	4.0 x 5.5mm



Double Ended Blades

Double ended screwdriver blades with hexagon shape, to fit holder MD901, also replacement parts for set TTMD12D.

Stock no.	Description	Tips
MD901	Handle for TTMD12D	-
PZZ0102	Combination blade	PZ1 - PZ2
PHH0102	Combination blade	PH1 - PH2
FTF04055	Combination blade	flat 4.0mm - flat 5.5mm
PHF0365	Combination blade	PH3 - flat 6.5mm
TXX1015	Combination blade	TX10 - TX15
TXX2025	Combination blade	TX20 - TX25
TXX3040	Combination blade	TX30 - TX40
HBH0303	Combination blade	hex ball 3.0mm - hex 3.0mm
HBH0404	Combination blade	hex ball 4.0mm - hex 4.0mm
HBH0505	Combination blade	hex ball 5.0mm - hex 5.0mm
HBH0606	Combination blade	hex ball 6.0mm - hex 6.0mm



Double Ended Blades →



MR500 Magnetic Charger

Supplied on a key ring this tool can be used to magnetise and/or demagnetise any type of screwdriver.

GET A GRIP WITH TENG TOOLS!

The two most important parts of any screwdriver are the tip and the handle. The length of the blade is chosen to suit the type of access needed but it is what you hold and what turns the screw that makes the difference between a good screwdriver and a not so good one.

If the tip is made from the correct material, to the right hardness and in the correct dimensions it will give a snug fit to the screw head which will make it much easier to apply torque without damaging the fastening or the blade slipping out of the screw. With our TT-MV material and exhaustive quality control tests you can be confident that a Teng Tools screwdriver will fit and fit securely.

When it comes to the design of the handle many screwdriver brands have gone off in all sorts of weird and wonderful directions with strange shapes, different materials and colour schemes that can look distinctly odd. Teng Tools have never ventured down this road, preferring instead to focus on the shape and function of the handle to create a screwdriver that fits the hand comfortably without slipping to allow more torque and fewer blisters.

The new range of Teng Tools screwdrivers has been developed in conjunction with experts in ergonomics and material technology but more importantly together with people who actually use screwdrivers to give a handle that really does give you a better grip.

Screwdrivers - flat type

Flat screwdrivers. DIN 5264. TT-MV PLUS steel, black tips, ergonomically designed bi-material handle with hanging hole. All Teng Tools screwdrivers are designed to have a hole in the handle which can also be used for securing the tool with a fall protection wire if needed.

Stock no.	a mm	b mm	Shaft type	Tip	L1 mm	L2 mm	Weight g	Handle
MD914N	0.4	2.5	round	parallel	50	146	24	S
MD915N	0.5	2.5	round	parallel	75	171	24	S
MD915N1	0.5	2.5	round	parallel	200	296	25	S
MD920N	0.5	3	round	parallel	75	171	27	S
MD920N1	0.5	3	round	parallel	100	196	31	S
MD916N	0.6	3.5	round	parallel	75	171	29	S
MD916N1	0.6	3.5	round	parallel	100	196	31	S
MD916N2	0.6	3.5	round	parallel	150	246	38	S
MD917N	0.8	4.0	round	parallel	100	196	31	S
MD917N1	0.8	4	round	parallel	400	496	41	S
MD917N2	0.8	4	round	parallel	150	246	38	S
MD922N	1.0	5.5	round	flared	75	246	38	S
MD923N	1.0	5.5	round	flared	150	258	64	M
MD923N1	1.0	5.5	round	flared	200	308	74	M
MD928N	1.2	6.5	round	flared	38	96	45	XS
MD928N1	1.2	6.5	round	flared	100	216	93	L
MD928N2	1.2	6.5	round	flared	150	266	105	L
MD928N3	1.2	6.5	round	flared	200	316	115	L
MD928N4	1.2	6.5	round	flared	100	208	105	M
MD928N5	1.2	6.5	round	flared	150	258	110	M
MD928N6	1.2	6.5	round	flared	200	308	113	M
MD928N7	1.2	6.5	round	flared	400	508	185	M
MD930N	1.6	10	round	flared	200	325	231	XL
MD931N	1.0	5.5	hexagon	flared	125	253	96	L
MD932N	1.2	6.5	hexagon	flared	100	216	101	L
MD932N1	1.2	6.5	hexagon	flared	150	266	114	L
MD932N2	1.2	6.5	hexagon	flared	400	516	181	L
MD934N	1.2	8	hexagon	flared	150	275	156	XL
MD935N	1.6	10	hexagon	flared	200	325	226	XL

Screwdrivers - Flat Type →

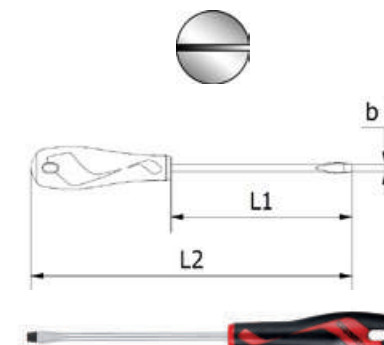

MDMC718N Flat tip screwdriver with pocket clip

Flat blade screwdriver. TT-MV PLUS steel, black tip, ergonomically designed bi-material handle with pocket clip.

Stock No.	Tip width mm	Blade length mm	Overall length mm	Weight g
MDMC718N	3.0	50	120	12



Screwdrivers - PH type

PH type screwdrivers. DIN 5260. TT-MV PLUS steel, black tips, ergonomically designed bi-material handle with hanging hole. All Teng Tools screwdrivers are designed to have a hole in the handle which can also be used for securing the tool with a fall protection wire if needed.

Stock no.	Size	Shaft type	Tip	L1 mm	L2 mm	Weight g	Handle
MD940N	PH0	round	phillips	75	171	27	S
MD940N1	PH0	round	phillips	300	369	41	S
MD947N	PH1	round	phillips	38	96	40	XS
MD947N1	PH1	round	phillips	75	183	29	M
MD947N2	PH1	round	phillips	150	258	61	M
MD948N	PH2	round	phillips	38	96	46	XS
MD948N1	PH2	round	phillips	100	216	93	L
MD948N2	PH2	round	phillips	200	316	115	L
MD948N3	PH2	round	phillips	400	516	153	L
MD948N4	PH2	round	phillips	100	208	90	M
MD948N5	PH2	round	phillips	200	308	110	M
MD948N8	PH2	round	phillips	300	408	114	M
MD948N6	PH2	round	phillips	400	508	148	M
MD949N	PH3	round	phillips	150	275	152	XL
MD950N	PH4	round	phillips	200	325	261	XL
MD952N	PH2	hexagon	phillips	100	216	101	L
MD952N1	PH2	hexagon	phillips	400	516	181	L
MD953N	PH3	hexagon	phillips	150	275	159	XL
MD954N	PH4	hexagon	phillips	200	325	231	XL

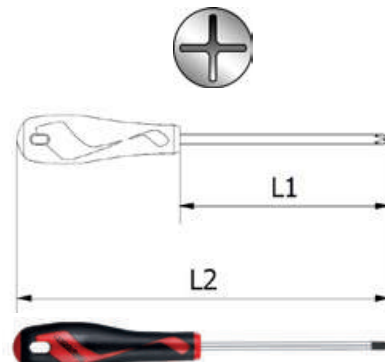

Screwdrivers - PH Type →

MDMC715N PH type screwdriver with pocket clip

PH type screwdriver. TT-MV PLUS steel, black tip, ergonomically designed bi-material handle with pocket clip.

Stock No.	Size	Blade length mm	Overall length mm	Weight g
MDMC715N	PH1	50	120	12

Screwdrivers - PZ type

PZ type screwdrivers. TT-MV PLUS steel, black tips, ergonomically designed bi-material handle with hanging hole. All Teng Tools screwdrivers are designed to have a hole in the handle which can also be used for securing the tool with a fall protection wire if needed.

Stock no.	Size	Shaft type	Tip	L1 mm	L2 mm	Weight g	Handle
MD960N	PZ0	round	pozi	75	171	27	S
MD961N	PZ1	round	pozi	75	183	29	M
MD961N1	PZ1	round	pozi	250	358	73	M
MD961N2	PZ1	round	pozi	38	96	40	XS
MD962N	PZ2	round	pozi	100	216	93	L
MD962N1	PZ2	round	pozi	150	266	105	L
MD962N2	PZ2	hexagon	pozi	100	216	101	L
MD962N3	PZ2	round	pozi	38	96	45	XS
MD962N4	PZ2	round	pozi	100	208	98	M
MD962N5	PZ2	round	pozi	150	258	100	M
MD962N4A	PZ2	round	pozi	200	308	93	M
MD962N4C	PZ2	round	pozi	300	408	93	M
MD962N4D	PZ2	round	pozi	400	508	93	M
MD963N	PZ3	hexagon	pozi	150	275	158	XL
MD964N	PZ4	hexagon	pozi	200	325	231	XL

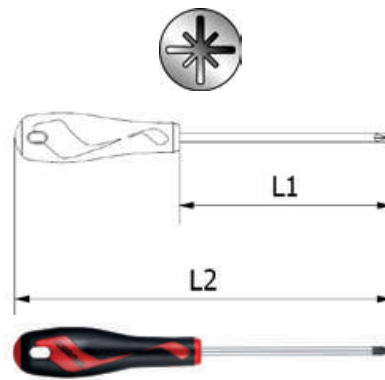

Screwdrivers - PZ Type →

MD906N1 6 Piece screwdriver set

Set of 6 TX drivers for TX drive heads. Features include TT-MV PLUS steel blades and ergonomically designed bi-material handles with hanging hole and T drive facility for added torque and comfort. Supplied in a full colour display box with PS tray. All Teng Tools screwdrivers are designed to have a hole in the handle which can also be used for securing the tool with a fall protection wire if needed.

TX drivers	TX type	TX10x100mm, TX15x100mm, TX20x100mm, TX25x100mm, TX30x100mm, TX40x100mm
------------	---------	--

MD906N2 6 Piece screwdriver set

Set of 6 screwdrivers for Pozi and TX drive heads. Features include TT-MV PLUS steel blades and ergonomically designed bi-material handles with hanging hole and T drive facility for added torque and comfort. Supplied in a full colour display box with PS tray. All Teng Tools screwdrivers are designed to have a hole in the handle which can also be used for securing the tool with a fall protection wire if needed.

Screwdrivers	PZ type	PZ1 x 75mm, PZ2 x 100mm
	TX type	TX10 x 100mm, TX15 x 100mm, TX20 x 100mm, TX25 x 100mm



TT917TXN 7 Piece Driver set

7 piece driver set covering TX8 through to TPX30. Features include TT-MV PLUS steel blades and ergonomically designed bi-material handles with hanging hole and T drive facility for added torque and comfort. Supplied in the unique Teng Tools TC tray with removable lid and dove tail joints for use on it's own or as part of the Teng Tools TC control system. All Teng Tools screwdrivers are designed to have a hole in the handle which can also be used for securing the tool with a fall protection wire if needed. (265x142x50mm, 0.7 kilos)

TX drivers	TX type	TX8x75mm, TX9x75mm, TPX10x100mm, TPX15x100mm, TPX20x100mm, TPX25x100mm, TPX30x100mm
------------	---------	---



TTD912TXN 12 Piece Screwdriver set

12 piece TX driver set covering TX6 through to TX45. Features include TT-MV PLUS steel blades and ergonomically designed bi-material handles with hanging hole and T drive facility for added torque and comfort. Supplied in the unique Teng Tools double TC tray with removable lid and dove tail joints for use on it's own or as part of the Teng Tools TC control system. All Teng Tools screwdrivers are designed to have a hole in the handle which can also be used for securing the tool with a fall protection wire if needed. (265x284x50mm, 1.2 kilos)

TX drivers	TX type	TX6x75mm, TX7x75mm, TX8x75mm, TX9x75mm, TX10x100mm, TX15x100mm, TX20x100mm, TX25x100mm, TX27x100mm, TX30x100mm, TX40x100mm, TX45x125mm
------------	---------	--



TED909TXN TX driver Set

9 piece TX driver set. Supplied in the unique Teng Tools double width TC tray with removable lid and dove tail joints for use on it's own or as part of the Teng Tools TC control system. The tools are held in place using the Teng Tools three colour pre-cut EVA foam tool control system. All Teng Tools screwdrivers are designed to have a hole in the handle which can also be used for securing the tool with a fall protection wire if needed. (265x284x50mm, 1.10 kilos)

TX drivers	TX6, TX8, TX9, TX10, TX15, TX20, TX25, TX27, TX30
------------	---



TX Screwdrivers

TX screwdrivers. Chrome vanadium, black tips, ergonomically designed bi-material handle with hanging hole. All Teng Tools screwdrivers are designed to have a hole in the handle which can also be used for securing the tool with a fall protection wire if needed.

Stock no.	Size	Shaft type	Tip	L1 mm	L2 mm	Weight g	Handle
MD906TN	TX6	round	-	75	171	29	S
MD907TN	TX7	round	-	75	171	29	S
MD908TN	TX8	round	-	75	171	29	S
MD909TN	TX9	round	-	75	171	29	S
MD910TN	TX10	round	-	100	208	58	M
MD915TN	TX15	round	-	100	208	58	M
MD920TN	TX20	round	-	100	208	58	M
MD925TN	TX25	round	-	100	216	93	L
MD927TN	TX27	round	-	100	216	94	L
MD930TN	TX30	round	-	100	216	94	L
MD940TN	TX40	round	-	100	216	106	L
MD945TN	TX45	round	-	125	205	237	XL

TX Screwdrivers →

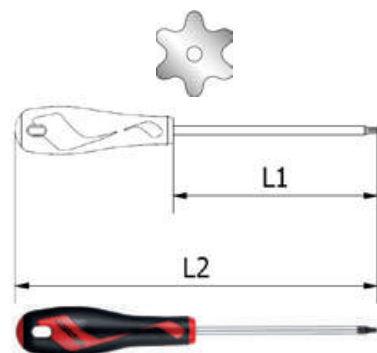
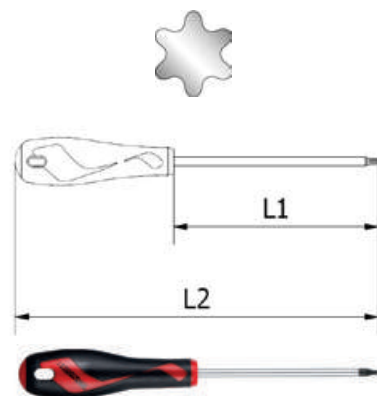

TPX Screwdrivers

TPX screwdrivers. Chrome vanadium, black tips, ergonomically designed bi-material handle with hanging hole. All Teng Tools screwdrivers are designed to have a hole in the handle which can also be used for securing the tool with a fall protection wire if needed.

Stock no.	Size	Shaft type	Tip	L1 mm	L2 mm	Weight g	Handle
MD610TPN	TPX10	round	-	100	208	58	M
MD615TPN	TPX15	round	-	100	208	58	M
MD620TPN	TPX20	round	-	100	208	58	M
MD625TPN	TPX25	round	-	100	216	94	L
MD627TPN	TPX27	round	-	100	216	94	L
MD630TPN	TPX30	round	-	100	216	94	L
MD640TPN	TPX40	round	-	100	216	105	L

TPX Screwdrivers →

ROB Screwdrivers

ROB screwdrivers. Chrome vanadium, black tips, ergonomically designed bi-material handle with hanging hole. All Teng Tools screwdrivers are designed to have a hole in the handle which can also be used for securing the tool with a fall protection wire if needed.

Stock no.	Size No.	Shaft type	Tip	L1 mm	L2 mm	Weight g	Handle
MD801N	1	round	square	100	216	94	L
MD802N	2	round	square	100	216	94	L
MD803N	3	round	square	100	216	94	L

ROB Screwdrivers →

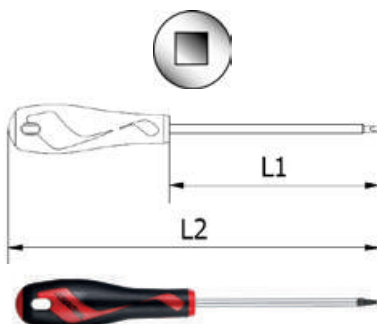

TM708 Mini Screwdriver set

8 piece Mini Screwdriver set. Consisting of 7 double ended blades with one tip in each end and one universal screwdriver handle. Supplied in a handy storage box with click lock. All Teng Tools screwdrivers are designed to have a hole in the handle which can also be used for securing the tool with a fall protection wire if needed. (170x90x35mm, 0.1 kilos)

Screwdriver blades 120mm	2.0mm flat x PH00, 3.0mm flat x PH0, 4.0mm flat x PH1, PZ0 x PZ1, TX5 x TX7, TX6 x TX8, TX9 x TX10
Screwdriver handle	



Mini Screwdrivers

Double ended mini screwdriver blades with hexagon shape, to fit holder MDM700, also replacement parts for set MDM708.

Stock no.	Description	Tips
MDM700	Handle	-
2912512	Combination blade	2.0mm flat - PH00
2912513	Combination blade	3.0mm flat - PH0
2912514	Combination blade	4.0mm flat - PH1
2912520	Combination blade	PZ0 - PZ1
2912535	Combination blade	TX5 - TX7
2912537	Combination blade	TX6 - TX8
2912539	Combination blade	TX9 - TX10

Mini Screwdriver Blades →



TTMI16 Mini plier & screwdriver set

Set containing 12 mini screwdrivers and 4 mini pliers. Supplied in the unique Teng Tools TC tray with removable lid and dove tail joints for use on it's own or as part of the Teng Tools TC control system. (265x142x50mm, 0.71 kilos)

Screwdrivers	Flat regular	2.0, 2.4, 3.0
	PH type	PH00, PH0, PH1
	TX type	TX6, TX7, TX8, TX9, TX10, TX15
Pliers	4 1/2" side cutter, 4 1/2" end cutter, 5" long nose, 5" flat nose	



MDM706 Mini Screwdriver set

Set of 6 mini screwdrivers. Supplied with rack/holder for wall mounting or for free standing. Made from CrMo alloy steel for extra strength. All Teng Tools screwdrivers are designed to have a hole in the handle which can also be used for securing the tool with a fall protection wire if needed.

Screwdrivers	Flat regular	2.0x40mm, 2.4x40mm, 3.0x40mm
	PH type	PH00x40mm, PH0x40mm, PH1x40mm



Mini Screwdrivers - hex type

Mini Hex Type Screwdrivers. Chrome vanadium, black tips. Made from CrMo alloy steel for extra strength.

Stock no.	Size mm	Shaft type	Tip	L1 mm	L2 mm	Weight g
MDM711	2.0	round	-	40	122	12
MDM712	2.5	round	-	40	122	12

Mini Screwdrivers - Hex Type →

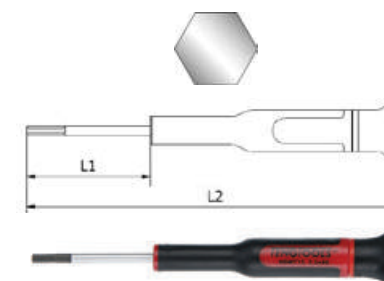

Mini Screwdrivers - flat type

Mini Flat Type Screwdrivers. Chrome vanadium, black tips. Made from CrMo alloy steel for extra strength.

Stock no.	Size mm	Shaft type	Tip	L1 mm	L2 mm	Weight g
MDM713	2.0	round	parallel	40	122	12
MDM714	2.4	round	parallel	40	122	12
MDM715	3.0	round	parallel	40	122	12

Mini Screwdrivers - Flat Type →

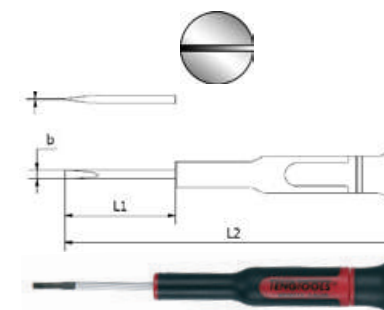

Mini Screwdrivers - PH type

Mini PH Type Screwdrivers. Chrome vanadium, black tips. Made from CrMo alloy steel for extra strength.

Stock no.	Size	Shaft type	Tip	L1 mm	L2 mm	Weight g
MDM716	PH00	round	-	40	122	12
MDM717	PH0	round	-	40	122	12
MDM718	PH1	round	-	40	122	12

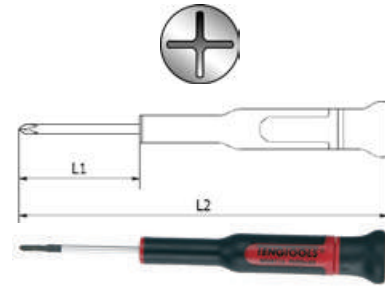

Mini Screwdrivers - PH Type →

DO'S AND DONT'S OF SCREWDRIVERS

- ✔ **The right tip**
 Use the correct type of screwdriver to suit the size and type of fastening you need to turn and how much torque you need to apply. The larger the handle and the longer the blade the more torque can be applied.
- ✔ **Keep it clean and dry**
 After use always check the tools are clean and dry before putting them away, this will help to avoid problems such as corrosion and moving parts seizing or becoming tight.
- ✔ **Apply extra torque correctly**
 If extra torque is needed make sure the driver is fitting tightly and securely and use extra torque by creating a T handle by using another screwdriver through the hanging hole. Alternatively on screwdrivers with a hexagon shank use a wrench or spanner to give extra torque.
- ✔ **Use the right handle**
 Teng Tools screwdrivers have different shaped handles for different applications. A round handle is ideal for transporting screws in and out of the thread, an oval handle gives much greater torque.
- ✘ **Do not use the wrong screwdriver**
 If the screwdriver does not fit tightly and securely to the screw or fastening check that you have the right size and type of screwdriver
- ✘ **Do not use a screwdriver as a lever**
 Screwdrivers are designed to apply torque laterally and will bend or break if used as a lever – not only bad for the tool but dangerous as well
- ✘ **Do not use on live electrics**
 If you have to work on electrical or electronic equipment disconnect the power supply wherever possible and always use insulated tools even if you believe that the power is off.
- ✘ **Do not use too much power**
 Only apply reasonable force, particularly on small fastenings and TX or TPX fastenings.

1477NX Assorted Key Set

8 piece set including hexagon, TX and screwdriver keys. Chrome vanadium steel. Retractable in aluminium case.

Accessories	ergonomically designed aluminium holder
Individual hex keys	4, 5, 6mm
Individual TX keys	TX25, TX30
Individual Screwdriver keys	1.0x5.5mm flat, PH1, PZ2



MDM706TX Mini TX T handle driver set

A set of 6 mini T handle TX drivers. Supplied with a handy rack for fixing to the wall or tool panel. Includes TX6, TX7, TX8, TX9, TX10 and TX15. Weight 124g.

Mini TX drivers

Individual mini T handle TX drivers

Stock no.	Size	Weight g
MDM806T	TX6	10
MDM807T	TX7	10
MDM808T	TX8	10
MDM809T	TX9	15
MDM810T	TX10	15
MDM815T	TX15	15



MDM706TX Mini Screwdrivers - TX type

Set of 6 mini screwdrivers for internal TX heads. Supplied with rack/holder for wall mounting or free standing. Made from CrMo alloy steel for extra strength.

Screwdrivers	TX type	TX6, TX7, TX8, TX9, TX10, TX15
--------------	---------	--------------------------------



Mini Screwdrivers - TX type

Mini TX Type Screwdrivers. Chrome vanadium, black tips. Made from CrMo alloy steel for extra strength.

Stock no.	Size	Shaft type	Tip	L1 mm	L2 mm	Weight g
MDM806	TX6	round	-	40	122	12
MDM807	TX7	round	-	40	122	12
MDM808	TX8	round	-	40	122	12
MDM809	TX9	round	-	40	122	12
MDM810	TX10	round	-	40	122	12
MDM815	TX15	round	-	40	122	12

Mini Screwdrivers - TX Type →

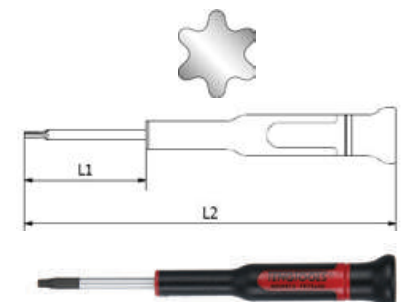

POLE POSITION ACCORDING TO TENG



OLE JOHAN, Chief Mechanic

Petter Solbergs rallycross car is maintained by me and my Teng Tools storage unit TCMM1055N. It's filled with 1055 pieces in 51 tool sets. All chosen by me, according to my preferences. For some, things organised perfectly might seem boring, but when it comes to chasing seconds, it's vital. Welcome to our world!



Get organised™

Screwdrivers

TTXMDTN

5 Piece Power Through Screwdriver Set

5 piece power through screwdriver set including flat, regular and PH types with ergonomically designed bi-material handle with hexagonal power thru blade and percussion cap in head of the handle. Supplied in the unique Teng Tools TTX tray for use on it's own or as part of the Teng Tools TC control system. (570x115x40mm, 1.4 kilos)



Power through screwdrivers	Flat regular	6.5 x 100mm, 8 x 150mm, 10 x 200mm
	PH type	PH2 x 100mm, PH3 x 150mm

TEXMDTN

Power Thru Screwdriver Set **NEW!**

5 piece power thru screwdriver set including flat, regular and PH types with ergonomically designed bi-material handle with hexagonal power thru blade and percussion cap in head of the handle. Supplied in the unique Teng Tools TTX tray for use on it's own or as part of the Teng Tools TC control system. (570x115x40mm, 1.4 kilos)



Screwdrivers	PH type	PH2 x 100mm, PH3 x 150mm
Screwdrivers	flat type	6.5x100, 8x150, 10x200mm

WRMDT05N

Power Through Screwdriver Set

5 piece power through screwdriver set. Screwdrivers have bi-material TPR grip for added comfort and grip with a percussion cap in the head for striking with a hammer. Complete with a wall rack for fixing to the wall or a work bench.

Screwdrivers	flat type	1.2x6.5x100, 1.2x8.0x150, 1.6x10x200mm
	PH	PH2x100, PH3x150mm



Power Through Screwdrivers – Flat Type

Mega Drive Power Through Flat screwdrivers. Chrome vanadium. The hexagonal blade allows tightening using an open ended spanner, with percussion cap in the handle. DIN5264

Stock no.	a	b	Shaft type	Tip	L1	L2	Weight	Handle
	mm	mm			mm	mm	g	
MDT932N	1.2	6.5	hexagon	flared	100	216	120	L
MDT934N	1.2	8	hexagon	flared	150	275	200	XL
MDT935N	1.6	10	hexagon	flared	200	325	200	XL

Power Thru screwdrivers – flat type →

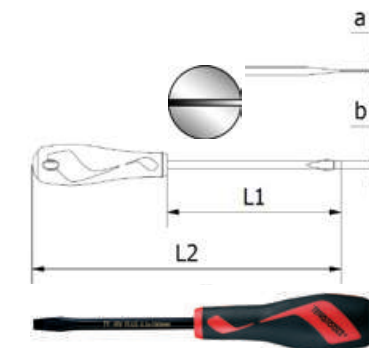

Power Through Screwdrivers – PH Type

Mega Drive Power Through PH type screwdrivers. Chrome vanadium. The hexagonal blade allows tightening using an open ended spanner, with percussion cap in the handle. DIN5264

Stock no.	Size	Shaft type	Tip	L1	L2	Weight	Handle
				mm	mm	g	
MDT952N	PH2	hexagon	phillips	100	216	120	L
MDT953N	PH3	hexagon	phillips	150	275	200	XL

Power Thru screwdrivers – PH type →

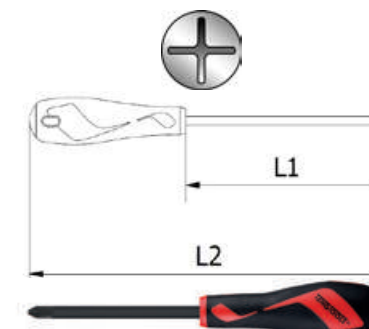

BITS AND BIT DRIVERS

Bit holder and bits

A comprehensive range of bits for screwdrivers and bit sets with numerous unique combinations of models and tips.



- All Teng Tools bits with a hexagonal drive are designed and manufactured in accordance with the latest industrial standards. Screwdriver bits and socket bits are classified as consumables and thus are only guaranteed to meet dimensional standards.
- The range comprises slotted tips, PH, PZ, GR type, square or Robertson type, TX, TPX, hex in metric sizes, imperial sizes and different lengths as well as various formats of hexagonal drive for individual needs.
- Full range of bit adapters, screw holders and accessories are available.
- Teng Tools unique bit sets mean resourceful storage in pocket format boxes, with bits that are easy to access and where the most popular bit holders are included.
- Different bit ratchet drivers and bit drivers are included in the range, among others bit drivers with 6 bits stored in the handle, stubby bit driver and a bit driver with folding handle for greater power transfer.



BBX10A 10 Piece Bits Box Set

A handy pocket sized bits box including a magnetic bits holder and nine assorted bits.

Accessories	50mm magnetic bits holder with 1/4" hex drive	
1/4" hex 25mm screwdriver bits	PZ type	1, 2, 3
	PH type	1, 2, 3
	Flat type	0.6x4.5, 1.0x5.5, 1.2x6.5mm



Whether it is Wheeler Dealer, Engine Addict, Turbo Pickers, Goblin Workshop or The Gadget Show you can expect to see Teng Tools – the preferred choice of TV experts.

T1419 19 Piece 1/4" Drive Socket Set

19 piece 1/4" drive socket set containing 6 point sockets, bits ratchet handle, magnetic bits holder, plus 11 bits. Supplied in a plastic case with snap lock and metal pin hinges. (105x60x32mm, 0.25 kilos)

Accessories	1/4" drive	1/4" bits ratchet, magnetic bits holder, 1/4" Mx1/4" Hex adaptor
Regular sockets	1/4" drive	6 point 8, 9, 10, 11, 12, 13mm
Bits	1/4" hex	4, 5, 6mm hex, PH1, PH2, PZ1, PZ2, 4.5mm flat, 5.5mm flat, 6.5mm flat



T1420 20 Piece 1/4" Drive Socket Set

20 piece 1/4" drive socket set containing 6 point sockets, bits ratchet handle, magnetic bits holder, plus 11 bits. Supplied in a plastic case with snap lock and metal pin hinges. (105x60x32mm, 0.2 kilos)

Accessories	1/4" drive	1/4" bits ratchet, magnetic bits holder, 1/4" Mx1/4" Hex adaptor
Regular sockets	1/4" drive	6 point 5.5, 6, 7, 8, 9, 10, 13mm
Bits	1/4" hex	TX10, TX15, TX20, PH1, PH2, PZ1, PZ2, 4mm flat, 5.5mm flat, 6.5mm flat



TM028 28 piece bits set

A 28 piece bits set in a Teng Tools bits box, containing 26 of the most common bits used in the market, together with a quick release bit holder and an adaptor 1/4" hex. (105x60x32mm, 0.2 kilos)

Bits	1/4" hex drive 25mm bits flat 0.6x4.5, 0.8x5.5, 1.0x6.5mm, PH 1, PH2, PH3, PZ1, PZ2, PZ3, TX10, TX15, TX20, TX25, TX30, TX40, TPX20, TPX25, TPX30, ROB No. 1, No. 2, No. 3, Hex 4mm, 5mm, 6mm GR no.2 (2 pc)
Accessories	1/4" hex drive 50mm quick release bit holder adaptor 1/4" hex x 1/4"



TM029 29 piece bits box

A 29 piece bits set in a Teng Tools bits box, containing 26 of the most common bits used in the market, together with a magnetic bit holder, an adaptor and the Teng Tools bits ratchet. (105x60x32mm, 0.23 kilos)

Bits	1/4" hex drive 25mm bits flat 0.6x4.5, 0.8x5.5, 1.2x6.5mm, PH 1, PH2, PH3, PZ1, PZ2, PZ3, TX10, TX15, TX20, TX25, TX30, TX40, TPX20, TPX25, TPX30, ROB No. 1, No. 2, No. 3, Hex 4mm, 5mm, 6mm, GR no.2 (2 pc)
Accessories	1/4" hex drive 50mm magnetic bits holder, 1/4" bits ratchet with 8mm ring spanner, Hex 1/4" and Square 1/4" 25mm adaptor



1400B 1/4" drive reversible ratchet

A 1/4" hex drive reversible ratchet with 8mm 12 point ring spanner. Drop forged. Chrome vanadium. Satin finish.



MDBH Bits driver

A magnetic bits holder with a bi-material grip handle for use with 1/4" hexagon bits.



MD900 Bits Driver

1/4" hex bit driver with magnetic bits holder and the Mega Drive bi-material grip handle with hanging hole/T drive facility.



MD907FL Flexible 1/4" Drive Magnetic Bits Driver **NEW!**

A 555mm long flexible bits driver with a magnetic 1/4" hex bits driver that holds the bit and ferrous fastenings in place. The spring wound flexible shaft is protected by a plastic sleeve. The bi-material grip includes a T drive facility for added torque or for use as a hanging hole. The hole can also be used for securing the tool to a safety wire. Overall length 555mm, weight 226g).



MD908N Bits Driver

A 9 piece bits driver set including the magnetic bits holder with a bi-material grip handle for use with 1/4" hexagon bits. 8 of the most commonly used bits are included in a handy bits holder.

Bits	1/4" hex drive 25mm flat bits	6.5mm, 8.0mm
	1/4" hex drive 25mm PH type bits	PH1, PH2
	1/4" hex drive 25mm PZ type bits	PZ1, PZ2
	1/4" hex drive 25mm hex type bits	4mm, 5mm



MDR908S Stubby Ratcheting Bits Driver Set

Stubby ratcheting bits driver Bi-material handle with storage in the handle for bits, reversible ratchet with forward, reverse and fixed settings. Supplied with 6 bits and a 1/4" square drive adaptor. Overall length 100mm.

Bits	1/4" hex drive 25mm flat bits	5mm, 7mm
	1/4" hex drive 25mm PH bits	PH1, PH2
	1/4" hex drive 25mm PZ bits	PZ1, PZ2
	1/4" hex drive 1/4" square drive adaptor	



TTMD74 Ratcheting bits driver set

74 piece set including ratcheting bits driver, 6" flexible extension, 69 bits, 4" extension bar, coupler adaptors. Supplied in the unique Teng Tools TC tray with removable lid and dove tail joints for use on it's own or as part of the Teng Tools TC control system. (265x142x50mm, 0.74 kilos)

Accessories	1/4" drive ratcheting bits handle including 6 bits PH1, PH2, PZ1, PZ2, 5 & 7mm flat, 6" flexible extension, 4" extension, 1/4" M:1/4" hex adaptor coupler, 1/4" F:1/4" hex coupler adaptor.
25mm hex bits	1/4" hex drive TX6, 7, 8, 9, 10, 15, 20x3, 25x3, 27, 30, 40.TPX10, 15, 20x2, 25x2, 27, 30, 40. 2, 3, 4, 5, 6, 8mm hex, 0.6x3.5, 0.6x4.5, 0.8x4.0, 0.8x5.5, 1.0x5.5, 1.2x5.0, 1.2x6.5, 1.4x7.0, 1.6x8.0mm flat, PH1x4, PH2x7, PH3x1, PZ1x4, PZ2x7, PZ3x1, 1, 2, 3 square, GR



TTMDRT64 Angled Ratcheting bits Driver Set

64 piece set including jointed bits driver with adjustable angle setting, 11 regular 1/4" drive metric sockets and 52 bits. Supplied in the unique Teng Tools TC tray with removable lid and dove tail joints for use on it's own or as part of the Teng Tools TC control system. (265x142x50mm, 0.85 kilos).

Accessories	1/4" drive ratcheting bits handle including 7 bits 5 & 7mm flat, PH1, PH2, PZ1, PZ2, 1/4" M:1/4" hex adaptor.
Regular sockets	1/4" drive 4, 5, 5.5, 6, 7, 8, 9, 10, 11, 12, 13mm
25mm bits	1/4" hex drive 0.6x3.5, 0.6x4.5, 0.8x4.0, 0.8x5, 0.8x5.5, 1.0x5.5, 1.2x6.5, 1.2x7.0, 1.6x8.0 flat, PH1 x 4, PH2 x 4, PH3 x 2, PZ1, PZ2 x 3, PZ3 x 2, TX6, TX7, TX8, TX9, TX10, TX15, TX20 x 3, TX25 x 3, TX27, TX30, TX40, 2, 3, 4(x 3), 5, 6, 8mm hex, 1, 2, 3 square.



TTXMD41N Flexible handle 1/4" drive Socket and Screwdriver Bit Set **NEW!**

Set of two flexible drivers together with 1/4" drive sockets and a selection of the most commonly used screwdriver bits. Supplied in the unique Teng Tools TTX tray for use on it's own or as part of the Teng Tools TC control system. (570x115x70mm, 1.36 kilos)

Accessories	555mm flexible spinner handle with 1/4" drive, 555mm flexible bits driver with 1/4" hex drive, 1/4" x 1/4" hex adaptor
Regular sockets	1/4" drive 4, 4.5, 5, 5.5, 6, 7, 8, 9, 10, 11, 12, 13mm
25mm hex bits	1/4" hex drive 0.8x4.0, 1.0x5.5, 1.6x8.0mm flat, PH0, PH1, PH2, PH3, PH4, PZ0, PZ1, PZ2, PZ3, TX8, TX10, TX15, TX20, TX25, TX27, TX30, TX40, 3, 4, 5, 6, 8, 10mm hex



TEDSD95 Torque Screwdriver, Impact Driver and Bit Set

1/4" drive 1-5Nm torque screwdriver and 1/2" drive impact driver together with assorted bits to suit most types of fastenings. Supplied in the unique Teng Tools double width TC tray with removable lid and dove tail joints for use on it's own or as part of the Teng Tools TC control system. The tools are held in place using the Teng Tools three colour pre-cut EVA foam tool control system. (265x284x50mm, 2.40 kilos)

Accessories	1/4" drive	1-5Nm torque screwdriver, quick release chuck, sliding T bar, 6" flexible extension, Ratchetting bits driver with assorted bits in the handle (5, 7mm flat, PH1, PH2, PZ1, PZ2, 1/4"M:1/4" hex adaptor)
	3/8" drive	3/8"M:5/16" hex adaptor
	1/2" drive	impact driver, 5/16" hex bit adaptor
5/16" hex 36mm bits	flat type	1.4x6, 1.4x8, 2.2x10, 1.8x12mm
	PH	PH1, PH2, PH3, PH4
	hex	4, 5, 6, 8mm
	TX	TX30, TX40, TX45, TX50, TX55
1/4" hex 25mm bits	flat type	0.6x3.5, 0.6x4.5, 0.8x4.0, 0.8x5.5, 1.0x5.5, 1.2x6.5, 1.6x8.0mm
	PH	PH1 (x3), PH2 (x6), PH3
	PZ	PZ1 (x3), PZ2 (x6), PZ3
	hex	2, 3, 4, 4, 6, 8mm
	TX	TX6, TX7, TX8, TX9, TX10, TX15, TX20 (x3), TX25 (x3), TX27, TX30, TX40
	TPX	TPX10, TPX15, TPX20 (x2), TPX25 (x2), TPX27, TPX30, TPX40
	Square	1, 2, 3
	GR	2 (x3)



MDR915 Ratcheting Bits Driver Set

Ratcheting bits driver. Bi-material handle with storage in the handle for bits, reversible ratchet with forward, reverse and fixed settings. Supplied with 7 double ended screwdriver bits.

Bits	1/4" hex drive double ended 32mm flat bits	4mm x 6mm
	1/4" hex drive double ended 32mm PH type bits	PH0 x PH3, PH1 x PH2
	1/4" hex drive double ended 32mm PZ type bits	PZ0 x PZ3, PZ1 x PZ2
	1/4" hex drive double ended 32mm TX type bits	TX10 x TX15, TX20 x TX25



MDR908 Ratcheting Bits Driver Set

Ratcheting bits driver. Bi-material handle with storage in the handle for bits, reversible ratchet with forward, reverse and fixed settings. Supplied with 6 bits and a 1/4" square drive adaptor. Overall length 175mm.

Bits	1/4" hex drive 25mm flat bits	5mm, 7mm
	1/4" hex drive 25mm PH bits	PH1, PH2
	1/4" hex drive 25mm PZ bits	PZ1, PZ2
	1/4" hex drive 1/4" square drive adaptor	



MDRT908 Angled Ratcheting Bits Driver

Jointed handle can be offset at up to 60° to create a pistol grip handle for added torque or used as a straight bits driver. A fixed or forward/reverse ratchet mechanism with a magnet that holds the bit in place as well as the screw (steel, etc). Bi-material handle with storage for bits – includes 5 and 7mm flat, PH1, PH2, PZ1, PZ2 and a 1/4" male adaptor for use with 1/4" drive sockets. Overall length 172mm.



M1410T5 Wing T5 set

Set containing a coupler adaptor and 9 5 wing T5 bits,

Bit Coupler adaptor	1/4" drive - 1/4" hex
Individual 1/4" hex 5 wing TX bits	10, 15, 20, 25, 27, 30, 40, 45, 50



1486 TX bit set

Set containing a coupler adaptor and 6 TX bits for internal TX heads.

Bit coupler adaptor	3/8" drive 1/4" hex
Individual 1/4" hex TX bits	TX10, TX15, TX20, TX25, TX30, TX40



1488 TX bit set

Set containing a coupler adaptor and three TX bits for internal TX heads.

Bit coupler adaptor	1/2" drive 5/16" hex
Individual 5/16" hex TX bits	TX45, TX50, TX55



FTF32406005 Double ended bits –flat type

32mm long double ended bits for slotted heads with 1/4" hex

Stock No.	Size (end 1)	Size (end 2)	Drive	Pack Qty	Length mm	Weight g
FTF32406005	flat 0.8 x 4mm	flat 1.2 x 6mm	1/4" hex	5	32	30



Bits - flat type

25mm long bits for slotted heads with 1/4" hex. DIN3126.

Stock no.	Size	Drive	Pack Qty	Length mm
FL2506A03	0.6x3.5	1/4" hex	3	25
FL2506B03	0.6x4.5	1/4" hex	3	25
FL2508A03	0.8x4.0	1/4" hex	3	25
FL2508B03	0.8x5.5	1/4" hex	3	25
FL2510A03	1.0x5.5	1/4" hex	3	25
FL2512A03	1.2x6.5	1/4" hex	3	25
FL2516A03	1.6x8.0	1/4" hex	3	25

Bits - Flat Type →

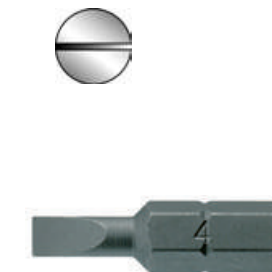

Bits - flat type

50mm long bits for slotted heads with 1/4" hex. DIN3126.

Stock No.	Size	Drive	Pack Qty	Length mm
FL5006A03	0.6x3.5	1/4" hex	3	50
FL5008A03	0.8x4.0	1/4" hex	3	50
FL5008B03	0.8x5.5	1/4" hex	3	50
FL5010A03	1.0x5.5	1/4" hex	3	50
FL5012A03	1.2x6.5	1/4" hex	3	50

Bits - Flat Type →

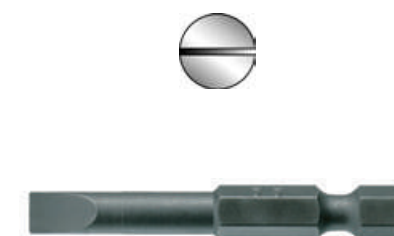

Bits - flat type

70mm long bits for slotted heads with 1/4" hex. DIN3126.

Stock no.	Size	Drive	Pack Qty	Length mm
FL7006A02	0.6x3.5	1/4" hex	2	70
FL7008A02	0.8x4.0	1/4" hex	2	70
FL7008B02	0.8x5.5	1/4" hex	2	70
FL7010A02	1.0x5.5	1/4" hex	2	70



Bits - Flat Type

Double ended bits – PH type

32mm long double ended bits for Phillips heads with 1/4" hex

Stock no.	Size (end 1)	Size (end 2)	Drive Qty	Pack mm	Length g	Weight
PHH3200305	PH0	PH3	1/4" hex	5	32	30
PHH32010205	PH1	PH2	1/4" hex	5	32	30



Bits - PH Type

Bits - PH type

25mm long standard bits for Phillips heads with 1/4" hex. DIN3126.

Stock no.	Size	Drive Qty	Pack mm	Length
PH2500103	PH1	1/4" hex	3	25
PH2500110	PH1	1/4" hex	10	25
PH2500203	PH2	1/4" hex	3	25
PH2500210	PH2	1/4" hex	10	25
PH2500303	PH3	1/4" hex	3	25
PH2500310	PH3	1/4" hex	10	25



Bits - PH Type

Bits - PH type

50mm long bits for Phillips heads with 1/4" hex. DIN3126.

Stock no.	Size	Drive Qty	Pack mm	Length
PH5000103	PH1	1/4" hex	3	50
PH5000203	PH2	1/4" hex	3	50
PH5000303	PH3	1/4" hex	3	50



Bits - PH Type

Bits - PH type

70mm long bits for Phillips heads with 1/4" hex. DIN3126.

Stock no.	Size	Drive	Pack Qty	Length mm
PH7000102	PH1	1/4" hex	2	70
PH7000202	PH2	1/4" hex	2	70



Bits - PH Type



Impact Bits - PH type **NEW!**

A new range of 1/4" hex drive impact bits with a range of lengths that includes 30, 50 and 89mm. Available individually with the 30mm length range also available in packs of 5.

Stock No.	Size	Drive	Pack qty	Length mm
PHP3000101	PH1	1/4" hex	1	30
PHP3000105	PH1	1/4" hex	5	30
PHP3000201	PH2	1/4" hex	1	30
PHP3000205	PH2	1/4" hex	5	30
PHP3000301	PH3	1/4" hex	1	30
PHP3000305	PH3	1/4" hex	5	30
PHP5000101	PH1	1/4" hex	1	50
PHP5000201	PH2	1/4" hex	1	50
PHP5000301	PH3	1/4" hex	1	50
PHP8900201	PH2	1/4" hex	1	89

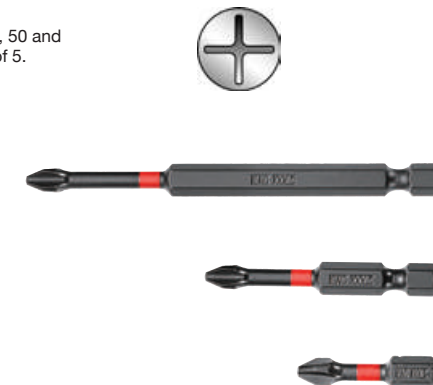

Bits - GR type

25mm long standard bits for Phillips heads with 1/4" hex. GR type with reduced neck. DIN3126.

Stock no.	Size	Drive	Pack Qty	Length mm
GR25002010	PH2	1/4" hex	10	25
GR25002100	PH2	1/4" hex	100	25

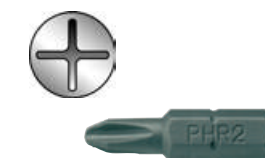

Impact Bits - GR type **NEW!**

New design impact bits for higher torsion.

Stock no.	Size	Drive	Pack Qty	Length mm
GRP3000201	GR2	1/4" hex	1	30
GRP3000205	GR2	1/4" hex	5	30
GRP5000201	GR2	1/4" hex	1	50



Double ended bits – PZ type

32mm long double ended bits for PZ heads with 1/4" hex

Stock no.	Size (end 1)	Size (end 2)	Drive Qty	Pack mm	Length g	Weight
PZZ32000305	PZ0	PZ3	1/4" hex	5	32	30
PZZ32010205	PZ1	PZ2	1/4" hex	5	32	30



Double ended bits –PZ type

Bits - PZ type

25mm long bits for PZ heads with 1/4" hex. DIN3126.

Stock no.	Size	Drive Qty	Pack mm	Length
PZ2500103	PZ1	1/4" hex	3	25
PZ2500110	PZ1	1/4" hex	10	25
PZ2500203	PZ2	1/4" hex	3	25
PZ2500210	PZ2	1/4" hex	10	25
PZ2500303	PZ3	1/4" hex	3	25
PZ2500310	PZ3	1/4" hex	10	25



Bits - PZ Type

Bits - PZ type

50mm long bits for PZ heads with 1/4" hex. DIN3126.

Stock no.	Size	Drive Qty	Pack mm	Length
PZ5000103	PZ1	1/4" hex	3	50
PZ5000203	PZ2	1/4" hex	3	50
PZ5000303	PZ3	1/4" hex	3	50



Bits - PZ Type



Bits - PZ type

70mm long bits for PZ heads with 1/4" hex. DIN3126.

Stock no.	Size	Drive	Pack Qty	Length mm
PZ7000102	PZ1	1/4" hex	2	70
PZ7000202	PZ2	1/4" hex	2	70

Bits - PZ Type

Impact bits - PZ type **NEW!**

New design impact bits for higher torsion.

Stock No.	Size	Drive	Pack qty	Length mm
PZP3000101	PZ1	1/4" hex	1	30
PZP3000105	PZ1	1/4" hex	5	30
PZP3000201	PZ2	1/4" hex	1	30
PZP3000205	PZ2	1/4" hex	5	30
PZP3000301	PZ3	1/4" hex	1	30
PZP3000305	PZ3	1/4" hex	5	30
PZP5000101	PZ1	1/4" hex	1	50
PZP5000201	PZ2	1/4" hex	1	50
PZP5000301	PZ3	1/4" hex	1	50
PZP8900201	PZ2	1/4" hex	1	89

Bits - hex type

25mm long standard bits for hex holes with 1/4" hex. DIN3126.

Stock no.	Size	Drive	Pack Qty	Length mm
HEX2500203	2	1/4" hex	3	25
HEX2500303	3	1/4" hex	3	25
HEX2500403	4	1/4" hex	3	25
HEX2500503	5	1/4" hex	3	25
HEX2500603	6	1/4" hex	3	25
HEX2500803	8	1/4" hex	3	25

Bits - Hex Type

Bits - hex type

50mm long bits for hex holes with 1/4" hex. DIN3126.

Stock no.	Size mm	Drive	Pack Qty	Length mm
HEX5000403	4	1/4" hex	3	50
HEX5000503	5	1/4" hex	3	50
HEX5000603	6	1/4" hex	3	50
HEX5000803	8	1/4" hex	3	50

Bits - Hex Type

Bits - hex type

40mm long bits for hex holes with 10 or 12mm hex. DIN3126.

Stock no.	Size mm	Drive	Pack Qty	Length mm
210705	5	10 hex	1	40
210706	6	10 hex	1	40
210707	7	10 hex	1	40
210708	8	10 hex	1	40
210709	9	10 hex	1	40
210710	10	10 hex	1	40
210712	12	12 hex	1	40
210714	14	12 hex	1	40
210717	17	12 hex	1	40
210719	19	12 hex	1	40

Bits - Hex Type

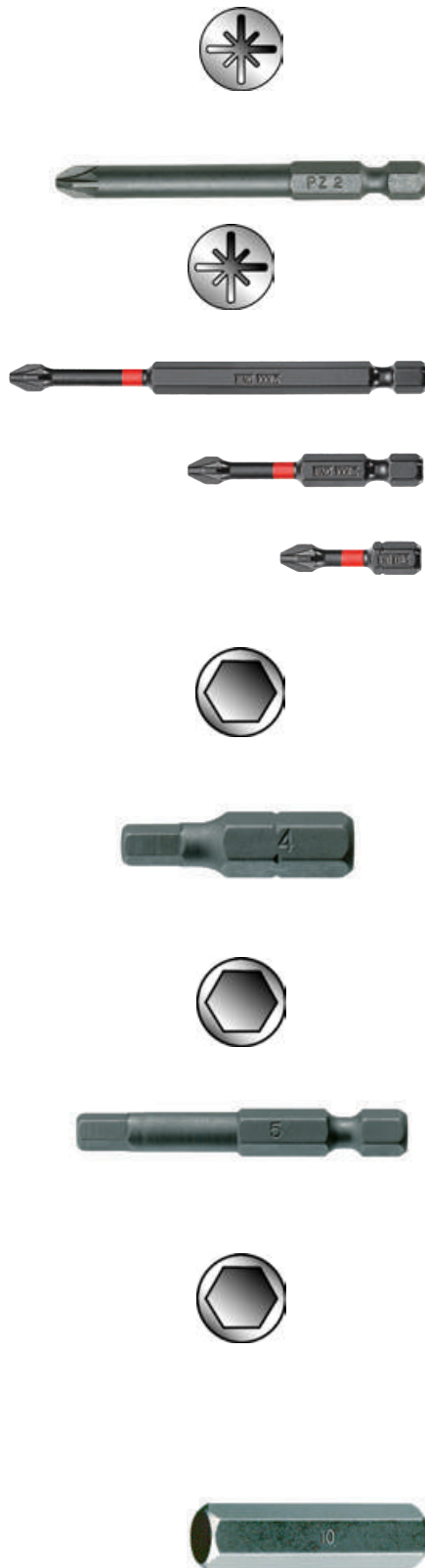

Bits - hex type

75mm long bits for hex holes with 10 or 12mm hex. DIN3126.

Stock no.	Size	Drive mm	Pack Qty	Length mm
210805	5	10 hex	1	75
210806	6	10 hex	1	75
210807	7	10 hex	1	75
210808	8	10 hex	1	75
210809	9	10 hex	1	75
210810	10	10 hex	1	75
210812	12	12 hex	1	75
210814	14	12 hex	1	75
210817	17	12 hex	1	75
210819	19	12 hex	1	75

Bits - Hex Type

Impact bits - HEXP range **NEW!**

New design impact bits for higher torsion.

Stock no.	Size	Drive mm	Pack Qty	Length mm
HEXP3000301	3mm	1/4" hex	1	30
HEXP3000305	3mm	1/4" hex	5	30
HEXP3000401	4mm	1/4" hex	1	30
HEXP3000405	4mm	1/4" hex	5	30
HEXP3000501	5mm	1/4" hex	1	30
HEXP3000505	5mm	1/4" hex	5	30
HEXP3000601	6mm	1/4" hex	1	30
HEXP3000605	6mm	1/4" hex	5	30
HEXP5000301	3mm	1/4" hex	1	50
HEXP5000401	4mm	1/4" hex	1	50
HEXP5000501	5mm	1/4" hex	1	50
HEXP5000601	6mm	1/4" hex	1	50

Double ended bits -TX type

32mm long double ended bits for TX heads with 1/4" hex

Stock no.	Size (end 1)	Size (end 2)	Drive	Pack Qty	Length mm	Weight g
TXX32101505	TX10	TX15	1/4" hex	5	32	30
TXX32202505	TX20	TX25	1/4" hex	5	32	30

Double ended bits -TX type

Bits - TX type

25mm long TX bits with 1/4" hex. For internal TX heads. DIN3126.

Stock no.	Size	Drive	Pack Qty	Length mm
TX2500603	TX6	1/4" hex	3	25
TX2500703	TX7	1/4" hex	3	25
TX2500803	TX8	1/4" hex	3	25
TX2500903	TX9	1/4" hex	3	25
TX2501003	TX10	1/4" hex	3	25
TX2501503	TX15	1/4" hex	3	25
TX2502003	TX20	1/4" hex	3	25
TX2502503	TX25	1/4" hex	3	25
TX2502703	TX27	1/4" hex	3	25
TX2503003	TX30	1/4" hex	3	25
TX2504003	TX40	1/4" hex	3	25

Bits - TX Type



Bits - TX type

40mm long TX bits with 10 and 12mm hex. DIN3126.

Stock no.	Size	Drive mm	Pack Qty	Length mm
220720	TX20	10	1	40
220725	TX25	10	1	40
220727	TX27	10	1	40
220730	TX30	10	1	40
220740	TX40	10	1	40
220745	TX45	10	1	40
220750	TX50	10	1	40
220755	TX55	10	1	40
220760	TX60	12	1	40
220770	TX70	12	1	40

Bits - TX Type

Bits - TX type

50mm long TX bits with 1/4" hex. For internal TX heads. DIN3126.

Stock no.	Size	Drive	Pack Qty	Length mm
TX5000803	TX8	1/4" hex	3	50
TX5001003	TX10	1/4" hex	3	50
TX5001503	TX15	1/4" hex	3	50
TX5002003	TX20	1/4" hex	3	50
TX5002503	TX25	1/4" hex	3	50
TX5002703	TX27	1/4" hex	3	50
TX5003003	TX30	1/4" hex	3	50

Bits - TX Type

Bits - TX type

70mm long TX bits with 1/4" hex. For internal TX heads. DIN3126.

Stock no.	Size	Drive	Pack Qty	Length mm
TX7001002	TX10	1/4" hex	2	70
TX7001502	TX15	1/4" hex	2	70
TX7002002	TX20	1/4" hex	2	70
TX7002502	TX25	1/4" hex	2	70

Bits - TX Type

Bits - TX type

75mm long TX bits with 10 or 12mm hex. For internal TX heads. DIN3126.

Stock no.	Size	Drive mm	Pack Qty	Length mm
220820	TX20	10	1	75
220825	TX25	10	1	75
220827	TX27	10	1	75
220830	TX30	10	1	75
220840	TX40	10	1	75
220845	TX45	10	1	75
220850	TX50	10	1	75
220855	TX55	10	1	75
220860	TX60	12	1	75
220870	TX70	12	1	75

Bits - TX Type



Impact bits - TXP range **NEW!**

New design impact bits for higher torsion.

Stock no.	Size	Drive mm	Pack Qty	Length mm
TXP3001001	TX10	1/4" hex	1	30
TXP3001005	TX10	1/4" hex	5	30
TXP3001501	TX15	1/4" hex	1	30
TXP3001505	TX15	1/4" hex	5	30
TXP3002001	TX20	1/4" hex	1	30
TXP3002005	TX20	1/4" hex	5	30
TXP3002501	TX25	1/4" hex	1	30
TXP3002505	TX25	1/4" hex	5	30
TXP3002701	TX27	1/4" hex	1	30
TXP3002705	TX27	1/4" hex	5	30
TXP3003001	TX30	1/4" hex	1	30
TXP3003005	TX30	1/4" hex	5	30
TXP3004001	TX40	1/4" hex	1	30
TXP3004005	TX40	1/4" hex	5	30
TXP5001001	TX10	1/4" hex	1	50
TXP5001501	TX15	1/4" hex	1	50
TXP5002001	TX20	1/4" hex	1	50
TXP5002501	TX25	1/4" hex	1	50
TXP5002701	TX27	1/4" hex	1	50
TXP5003001	TX30	1/4" hex	1	50
TXP5004001	TX40	1/4" hex	1	50
TXP8902001	TX20	1/4" hex	1	89
TXP8902501	TX25	1/4" hex	1	89
TXP8903001	TX30	1/4" hex	1	89



Bits - TPX type

25mm long TPX bits with hole (for tamper proof screws) with 1/4" hex. For internal TPX heads. DIN3126.

Stock No.	Size	Drive	Pack Qty	Length mm
TPX2501003	TPX10	1/4" hex	3	25
TPX2501503	TPX15	1/4" hex	3	25
TPX2502003	TPX20	1/4" hex	3	25
TPX2502503	TPX25	1/4" hex	3	25
TPX2502703	TPX27	1/4" hex	3	25
TPX2503003	TPX30	1/4" hex	3	25
TPX2504003	TPX40	1/4" hex	3	25

Bits - TPX Type



Bits - square type

Standard bits for ROB type recessed heads with 1/4" hex. DIN3126.

Stock No.	Size	Drive	Pack Qty	Length mm
ROB2500103	Square 01	1/4" hex	3	25
ROB2500203	Square 02	1/4" hex	3	25
ROB2500303	Square 03	1/4" hex	3	25

Bits - Square Type



Impact bits - ROBP range **NEW!**

New design impact bits for higher torsion.

Stock no.	Size	Drive mm	Pack Qty	Length mm
ROBP3000101	RS1	1/4" hex	1	30
ROBP3000105	RS1	1/4" hex	5	30
ROBP3000201	RS2	1/4" hex	1	30
ROBP3000205	RS2	1/4" hex	5	30
ROBP5000101	RS1	1/4" hex	1	50
ROBP5000201	RS2	1/4" hex	1	50
ROBP5000301	RS3	1/4" hex	1	50



Extension bars

1/4" hex extension bars for 1/4" hex bits when used together with a 1/4" hex driver. With knurled grip for easier use and a spring loaded ball bearing for gripping the bits.

Stock No.	Drive	Description	Length mm
TTMD74-1	1/4" hex	Fixed extension bar	100mm (4")
TTMD74-2	1/4" hex	Flexible extension	150mm (6")

Extension Bars



ACC300CBH01 Flexible extension bar

A 300mm flexible 1/4" hex extension for working in hard to reach areas. Maximum torque 3Nm. Overall length 300mm, weight 140g

Bit Holders

Recessed magnet holds the bits as well as the screw with 1/4" hex.

Stock no.	Description	Drive	Length mm
ACC50MBH01	50mm magnetic bit holder	1/4" hex	50
ACC70MBH01	70mm magnetic bit holder	1/4" hex	70
ACC35CBH01	35mm chuck bit and holder	1/4" hex	35
ACC50CBH01	50mm chuck bit holder	1/4" hex	50

Bit Holders



Coupler Adaptors

Coupler adaptors for Teng Tools bits.

Stock No.	Drive	DIN	Description	Weight
M140060-C	1/4"	3126	coupler adaptor for 1/4" hex bits	20
M380060-C	3/8"	3126	coupler adaptor for 1/4" hex bits	32
M380061-C	3/8"	3126	coupler adaptor for 10mm hex bits	32
M120060-C	1/2"	3126	coupler adaptor for 5/16" hex bits	88
M120061-C	1/2"	3126	coupler adaptor for 10mm hex bits	56
M120062-C	1/2"	3126	coupler adaptor for 12mm hex bits	62
M120063-C	1/2"	3126	coupler adaptor for 1/4" hex bits	88

Coupler Adapters



Bit Adaptors

For use with standard and impact sockets, etc. on electric and rechargeable screwdrivers (not impact tools). Designed for use with the most common machine fittings (type 4).

Stock no.	Description	Hex	Square
ACCSDA1414	50mm adaptor	1/4	1/4
ACCSDA1438	50mm adaptor	1/4	3/8
ACCSDA1412	50mm adaptor	1/4	1/2

Bit Adaptors



Nut Setters

Magnetic type nut setters. For use in electric and rechargeable screwdrivers.

Stock no.	Size	Drive	Type	Length mm
NS45108M	1/4"	1/4" hex	Magnetic	45
NS45506M	6mm	1/4" hex	Magnetic	45
NS45507M	7mm	1/4" hex	Magnetic	45
NS45508M	8mm	1/4" hex	Magnetic	45
NS45508R	8mm	1/4" hex	Ring	45

Nut Setters →



Teng Tools

Teng Tools

1000-volt insulated tools

1000-volt tools must always be used for electrical work. A tested and approved 1000-volt tool can protect the user against voltages of up to 1000 volts. Approval means that the tool must be insulated and tested according to IEC 60 900 and DIN 60 900, and not just according to VDE 0680.



- IEC 60 900 is an international standard for testing tools designed for electrical work on the production line.
- DIN 60 900 is a European standard drawn up in 1995 and which states that each individual tool must be tested with regard to insulation for 1000 volts.
- VDE is an independent authority that tests and checks tools with regard to construction, production and packaging. It is not the same as IEC 60 900 or DIN 60 900.



All 1000-volt tools from Teng Tools satisfy all these standards completely. They conform or exceed all specifications that the relevant authorities have established. Each tool is individually tested before it is marked with a special standard tag and a marking that indicates the year of manufacture.

The screwdriver shaft in the 1000 volt range is covered with two layers of insulation in different colours that make it easy to see whether the insulation is damaged. The blades are insulated before the handle is moulded, which makes the screwdrivers safer.



INSULATED TOOLS

All 1000-volt pliers and screwdrivers from Teng Tools are tested with regard to:

- Insulation properties, i.e. resistance up to 1000 volts in dry or humid environments.
- Resistance to the cold, i.e. how well the tool withstands the cold.
- Durability, i.e. that the insulating handles do not come loose.
- Resistance to fire, i.e. how well the tool withstands fire.
- Insulating properties under pressure, i.e. how well the tool maintains its insulating properties when subjected to pressure.



TV18N 18 Piece 1,000 volt insulated tool set

Set of thirteen 1,000 volt insulated screwdrivers including flat as well as PH and PZ types. Features include TT-MV PLUS steel blades and ergonomically designed bi-material handles with hanging hole and T drive facility for added torque and comfort. Also includes five 1,000 volt insulated pliers with ergonomically designed bi-material handles for greater grip and torque. All produced and tested according to the EN60900 standard. Approved for working up to 1,000 volt AC. Supplied in the Teng Tools carrying case with latch lid, retractable handle and metal pin hinges. The underside of the case is fitted with rubber feet to prevent it from sliding. (466x258x103mm, 4.7 kilos)

Screwdrivers	Flat regular	2.5x75mm, 3.0x100mm, 4.0x100mm, 5.5x125mm, 6.5x150mm
Screwdrivers	PH type	PH0x60mm, PH1x80mm, PH2x100mm, PH3x150mm
Screwdrivers	PZ type	PZ0x60mm, PZ1x80mm, PZ2x100mm, PZ3x150mm
Pliers		6" side cutters, 8" heavy duty side cutters, 8" combination, 8" long nose, 7" wire strippers



MD912N1 12 Piece screwdriver set

Set of 12 screwdrivers for slotted heads as well as Phillips, Pozi and TX drive heads, including the most popular 1,000 volt insulated screwdrivers (produced and tested according to the EN60900 standard. Approved for working up to 1,000 volt AC). Features include TT-MV PLUS steel blades and ergonomically designed bi-material handles with hanging hole and T drive facility for added torque and comfort. Supplied in a full colour display box with PS tray.

Screwdrivers	Flat regular	3.0x75mm, 3.5x100mm, 5.5x150mm, 2.5x75mm insulated, 3.0x100mm insulated.
	PH type	PH1x75mm, PH2x100mm, PH1x80mm insulated
	PZ type	PZ2x100mm
	TX type	TX20x100mm, TX25x100mm, TX30x100mm

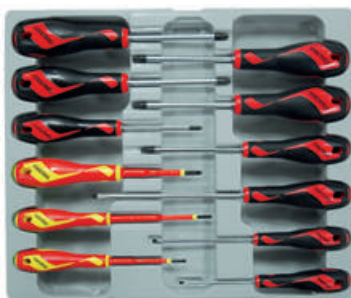

MDV906N 6 Piece 1,000 volt insulated screwdriver set

Set of six 1,000 volt insulated screwdrivers including flat as well as PH types. Features include TT-MV PLUS steel blades and ergonomically designed bi-material handles with hanging hole and T drive facility for added torque and comfort. All produced and tested according to the EN60900 standard. Approved for working up to 1,000 volt AC. Supplied in a full colour display box with PS tray.

Screwdrivers	Flat regular	2.5x75mm, 3.0x100mm, 4.0x100mm, 5.5x125mm
Screwdrivers	PH type	PH1x80mm, PH2x100mm



TTV706N 1,000 Volt Insulated Screwdriver With Reduced Blade Diameter Set **NEW!**

Set of six 1,000 volt insulated screwdrivers with reduced blade diameter shafts for access in difficult to reach places and recessed fixings. All produced and tested according to the EN60900 standard. Approved for working up to 1,000 volt AC. Supplied in the unique Teng Tools TC tray with removable lid and dove tail joints for use on it's own or as part of the Teng Tools TC control system. (265x142x50mm, 0.60 kilos)

Screwdrivers	flat type	0.8x4.0x100, 1.0x5.5x125mm
Screwdrivers	PH type	PH1x80, PH2x100mm
Screwdrivers	PZ type	PZ1x80, PZ2x100mm



TTV907N Insulated Screwdriver Set

Set of seven 1,000 volt insulated screwdrivers including flat as well as PH and PZ types. Features include TT-MV PLUS steel blades and ergonomically designed bi-material handles with hanging hole and T drive facility for added torque and comfort. All produced and tested according to the EN60900 standard. Approved for working up to 1,000 volt AC. Supplied in the unique Teng Tools TC tray with removable lid and dove tail joints for use on it's own or as part of the Teng Tools TC control system. (265x142x50mm, 0.65 kilos)

Screwdrivers	Flat type	2.5x75mm, 4.0x100mm, 5.5x125mm
	PH type	PH0 x 60mm, PH1 x 80mm, PH2 x 100mm
	PZ type	PZ2 x 100mm



TTDV910N 10 Piece Insulated Screwdriver Set

Set of ten 1,000 volt insulated screwdrivers including flat as well as PH and PZ types. Features include TT-MV PLUS steel blades and ergonomically designed bi-material handles with hanging hole and T drive facility for added torque and comfort. All produced and tested according to the EN60900 standard. Approved for working up to 1,000 volt AC. Supplied in the unique Teng Tools double TC tray with removable lid and dove tail joints for use on it's own or as part of the Teng Tools TC control system. (265x284x50mm, 1.2 kilos)

Screwdrivers	Flat type	2.5x75mm, 3.0x100mm, 4.0x100mm, 5.5x125mm
	PH type	PH0 x 60mm, PH1 x 80mm, PH2 x 100mm
	PZ type	PZ0x60mm, PZ1x80mm, PZ2 x 100mm



TEDV909N 1,000 Volt Insulated Screwdriver Set

9 piece 1,000 volt insulated screwdriver set. Supplied in the unique Teng Tools double width TC tray with removable lid and dove tail joints for use on it's own or as part of the Teng Tools TC control system. The tools are held in place using the Teng Tools three colour pre-cut EVA foam tool control system. (265x284x50mm, 1.02 kilos)

Screwdrivers	flat type	2.5x75, 3.5x100, 4.0x100, 5.5x125mm
Screwdrivers	PH type	PH0, PH1, PH2
Screwdrivers	PZ type	PZ2
Voltage tester		100-250 volts



WRMDV05N 1,000 volt insulated screwdriver set

5 piece 1,000 volt insulated screwdriver set. Screwdrivers have bi-material TPR grip for added comfort and grip. Complete with a wall rack for fixing to the wall or a work bench.

Screwdrivers	flat type	0.5x3.0x100, 1.0x5.5x125mm
	PH	PH1x80, PH2x100mm
	PZ	PZ2x100mm



WRMDV07N 1,000 volt insulated screwdriver set

7 piece 1,000 volt insulated screwdriver and voltage tester set. Screwdrivers have bi-material TPR grip for added comfort and grip. Complete with a wall rack for fixing to the wall or a work bench.

Screwdrivers	flat type	0.4x2.5x75, 0.5x3.0x100, 0.8x4.0x100, 1.0x5.5x125mm
	PH	PH1x80mm, PH2x100mm
Voltage tester		100 to 250 volts

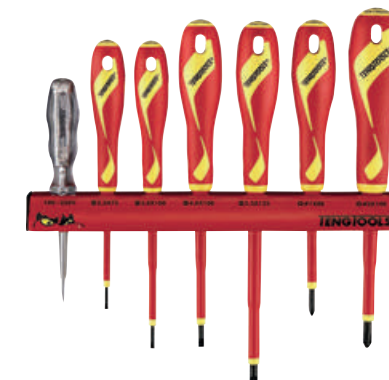

Insulated Screwdrivers - flat type

Insulated Flat tip screwdrivers with two component handles and black tips. Produced and tested according to the EN 60900 standard. Approved for live working up to 1000 volt AC.

Stock no.	a mm	b mm	Shaft type	L1 mm	L2 mm	Weight g	Handle
MDV820N	0.4	2.5	insulated	75	171	49	S
MDV822N	0.5	3.0	insulated	100	196	56	S
MDV823N	0.6	3.5	insulated	100	196	58	S
MDV824N	0.8	4.0	insulated	100	208	60	M
MDV826N	1.0	5.5	insulated	125	233	89	M
MDV828N	1.2	6.5	insulated	150	266	135	L

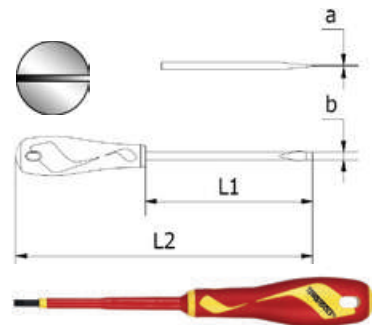

Insulated Screwdrivers - Flat Type →

Insulated Screwdrivers – flat type with reduced blade diameter) **NEW!**

Reduced blade diameter 1,000 volt insulated screwdrivers with integrated protective insulation and ultra slim blades for easier access to recessed screws and spring elements. The ergonomic design, bi-material handles also feature a large diameter design for excellent torque transmission and grip. DIN899 and produced and tested in accordance with the EN60900 standard. Approved for working up to 1,000 volt AC.

Stock no.	A mm	B mm	C mm	D mm	Shaft type	L1 mm	L2 mm	Weight g
MDV724N	0.8	4.0	15	31.5	RBD	101	210	51
MDV726N	1.0	5.5	15	31.5	RBD	127	235	66

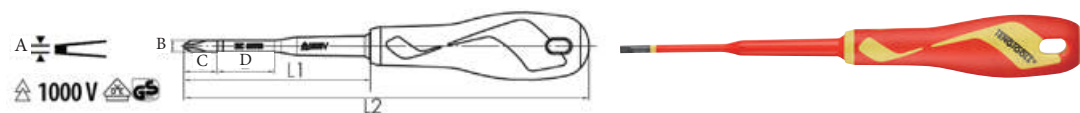

Insulated Screwdrivers – Flat Type RBD →

Insulated Screwdrivers - PH type

Insulated PH type tip screwdrivers with two component handles and black tips. Produced and tested according to the EN 60900 standard. Approved for live working up to 1000 volt AC.

Stock no.	Size mm	Shaft type	L1 mm	L2 mm	Weight g	Handle
MDV840N	PH0	insulated	60	156	49	S
MDV842N	PH1	insulated	80	188	54	M
MDV844N	PH2	insulated	100	216	118	L
MDV846N	PH3	insulated	150	275	177	XL

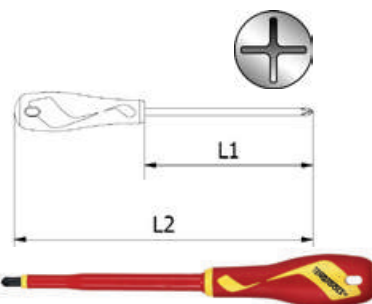

Insulated Screwdrivers - PH Type →

Insulated Screwdrivers – PH type with reduced blade diameter **NEW!**

Reduced blade diameter 1,000 volt insulated screwdrivers with integrated protective insulation and ultra slim blades for easier access to recessed screws and spring elements. The ergonomic design, bi-material handles also feature a large diameter design for excellent torque transmission and grip. DIN899 and produced and tested in accordance with the EN60900 standard. Approved for working up to 1,000 volt AC.

Stock no.	A mm	B mm	C mm	D mm	Shaft type	L1 mm	L2 mm	Weight g
MDV742N	PH1	4.5	18	30.0	RBD	81	190	51
MDV744N	PH2	6.0	18	30.5	RBD	100	217	95

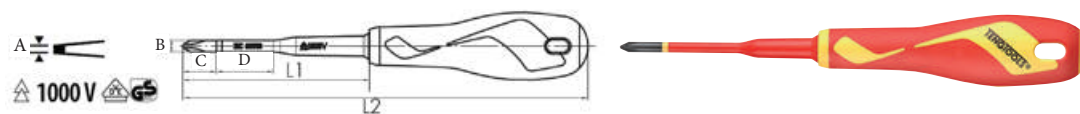

Insulated Screwdrivers – PH Type RBD →

Insulated Screwdrivers - PZ type

Insulated PZ type tip screwdrivers with two component handles and black tips. Produced and tested according to the EN 60900 standard. Approved for live working up to 1000 volt AC.

Stock no.	Size	Shaft type	L1 mm	L2 mm	Weight g	Handle
MDV860N	PZ0	insulated	60	156	49	S
MDV862N	PZ1	insulated	80	188	54	M
MDV864N	PZ2	insulated	100	216	118	L
MDV866N	PZ3	insulated	150	275	177	XL

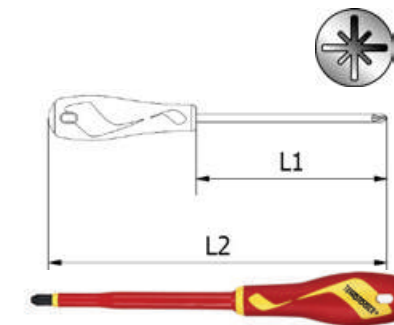

Insulated Screwdrivers - PZ Type →

Insulated Screwdrivers – PZ type with reduced blade diameter **NEW!**

Reduced blade diameter 1,000 volt insulated screwdrivers with integrated protective insulation and ultra slim blades for easier access to recessed screws and spring elements. The ergonomic design, bi-material handles also feature a large diameter design for excellent torque transmission and grip. DIN899 and produced and tested in accordance with the EN60900 standard. Approved for working up to 1,000 volt AC.

Stock no.	A mm	B mm	C mm	D mm	Shaft type	L1 mm	L2 mm	Weight g
MDV762N	PZ1	4.5	18	30.0	RBD	81	190	51
MDV764N	PZ2	6.0	18	30.5	RBD	100	217	95

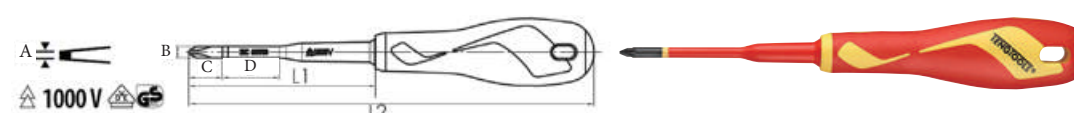

Insulated Screwdrivers – PZ Type RBD →

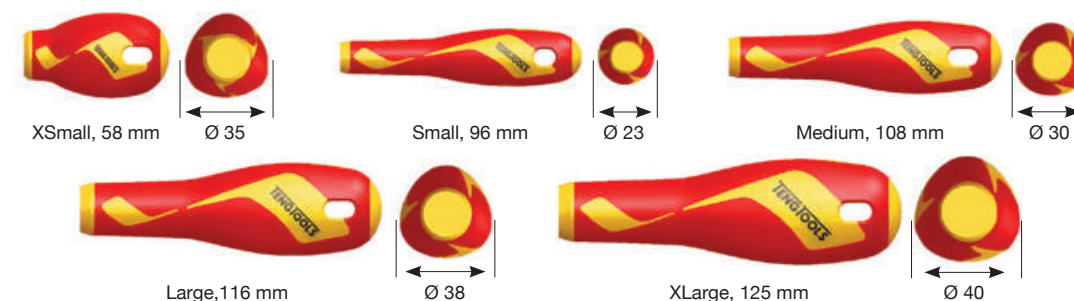

Insulated Screwdrivers - Plus/Minus type

Insulated plus/minus type tip screwdrivers for slotted/PH2 and slotted/PH type head. Two component handles and black tips. Produced and tested according to the EN60900 standard. Approved for live working up to 1000 volt AC.

Stock no.	Size	Shaft type	L1 mm	L2 mm	Weight g	Handle
MDV844NF	slotted/PH2	insulated	100	216	118	L
MDV864NF	slotted/PZ2	insulated	100	216	118	L

Insulated Screwdrivers - Plus/Minus type →

Insulated Screwdrivers - ROB type

Insulated ROB type tip screwdrivers with two component handles and black tips. Produced and tested according to the EN60900 standard. Approved for live working up to 1000 volt AC.

Stock no.	Size	Shaft type	L1 mm	L2 mm	Weight g	Handle
MDV802N	ROB2	insulated	100	216	118	L

Insulated Screwdrivers - ROB type →

TTV440 Insulated plier set

4 piece Mega Bite insulated plier set, all produced and tested according to the EN 60900 standard. Approved for live working up to 1000 volt AC. Supplied in the unique Teng Tools TC tray with removable lid and dove tail joints for use on it's own or as part of the Teng Tools TC control system. (265x142x50mm, 1.1 kilos)

Pliers	6" side cutter (capacity 0.5mm piano wire), 7" combination (capacity 2.0mm piano wire), 8" long nose, 7" wire stripper (capacity 0.2-3.0mm).
--------	--

TEDV440 1,000 Volt Insulated Plier Set

4 piece 1,000 volt insulated plier set. Supplied in the unique Teng Tools double width TC tray with removable lid and dove tail joints for use on it's own or as part of the Teng Tools TC control system. The tools are held in place using the Teng Tools three colour pre-cut EVA foam tool control system. (265x284x50mm, 1.28 kilos)

Pliers	6" side cutters, 8" long nose pliers, 8" combination pliers, 7" wire stripping pliers.
--------	--

WRMBV04 1,000 volt insulated plier set

4 piece 1,000 volt insulated plier set. Pliers have bi-material TPR grip for added comfort and grip. Complete with a wall rack for fixing to the wall or a work bench.

Pliers	6" side cutters, 8" heavy duty side cutters, 7" combination and 8" long nose
--------	--

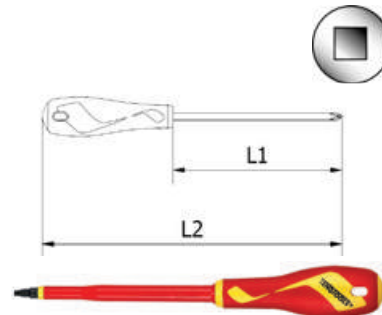
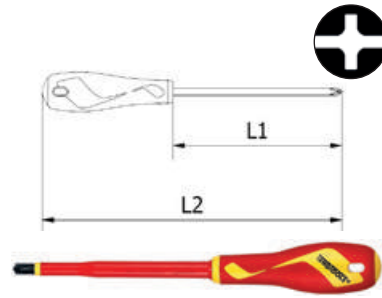

MBV441-6 Insulated Side Cutters

Insulated Mega Bite side cutting pliers. Chrome Molybdenum steel 80° cutting edge angle. Produced and tested according to the EN 60900 standard. Approved for live working up to 1000 volt AC. DIN5749.



Length mm	Length inch	Cutting capacity (mm) Piano wire	Cutting capacity (mm) Hard wire	Cutting capacity (mm) Medium hardness	Weight g
150	6	1.6	2.0	2.5	206

MBV442-8 Insulated Side Cutters

Insulated heavy duty Mega Bite side cutting pliers. Chrome Molybdenum steel 80° cutting edge angle. Produced and tested according to the EN 60900 standard. Approved for live working up to 1000 volt AC. DIN5749.



Length mm	Length inch	Cutting capacity (mm) Piano wire	Cutting capacity (mm) Hard wire	Cutting capacity (mm) Medium hardness	Weight g
200	8	2.5	3.0	4.0	305

Insulated Combination Pliers

Insulated Mega Bite combination pliers. Chrome Molybdenum steel 80° cutting edge angle. Produced and tested according to the EN 60900 standard. Approved for live working up to 1000 volt AC. DIN5746.



Insulated Combination Pliers →

Stock no.	Length mm	Length inch	Cutting capacity (mm) Piano wire	Cutting capacity (mm) Hard wire	Cutting capacity (mm) Medium hardness	Weight g
MBV451-7	175	7	1.8	2.0	3.8	225
MBV451-8	200	8	2.0	2.2	4.0	283

MBV461-8 Insulated Long Nose Pliers

Insulated Mega Bite long nose pliers. Chrome Molybdenum steel 80° cutting edge angle. Produced and tested according to the EN 60900 standard. Approved for live working up to 1000 volt AC. DIN5745.



Length mm	Length inch	Cutting capacity (mm) Piano wire	Cutting capacity (mm) Hard wire	Cutting capacity (mm) Medium hardness	Weight g
200	8	1.5	1.8	2.8	199

MBV499-7 Insulated Wire Stripping Pliers

Insulated Mega Bite wire stripping pliers. Spring action. Chrome Molybdenum steel 80° cutting edge angle. Produced and tested according to the EN 60900 standard. Approved for live working up to 1000 volt AC.



Length mm	Length inch	Cutting capacity (mm) Piano wire	Weight g
155	6	0.2 to 4.5	175

Pliers

The extensive Teng Tools range includes pliers for most applications. In addition, the range includes the usual side cutters, combination pliers and slip joint pliers as well as a number of cable pliers, side cutters for cable ties, frapping pliers, nail nippers, electronic pliers, precision shears and tweezers. Handles are available in two models to suit the user: slim rubber dipped as well as ergonomic bi-material handles.



- Steel alloy with CrMo gives a greater cutting capacity.
- The cutting capacity is laser marked next to the cutting edge – makes it easy to see which pliers you need to choose.
- Slim design gives better accessibility.
- The total length is designed to provide maximum leverage for each pair of pliers, irrespective of whether they are combination, water pump, flat or circlip pliers.
- Two handle types to choose from on many models – a slim rubber dipped handle or an ergonomic bi-material handle for a more comfortable grip.
- The ergonomic handle is wider where needed to support the palm of your hand when using greater force. However, it is also narrower, lighter and less bulky where needed.
- The cutting edges on cutting pliers are especially angled to suit different materials and application areas.
- The stripping pliers feature an integrated spring function.
- The new slip joint pliers have a button for quick setting of the jaw opening.



PLIERS

TT440 Plier set

Set of 4 Mega Bite pliers: water pump pliers, combination pliers, side cutters and long nose pliers. Made of chrome molybdenum steel. Plastic covered handles. Supplied in the unique Teng Tools TC tray with removable lid and dove tail joints for use on it's own or as part of the Teng Tools TC control system. (265x142x50mm, 1.1 kilos)

Pliers	6" side cutter, 7" combination, 8" long nose, 10" water pump
--------	--



TTD441 8 Piece Plier Set

8 piece plier set made of chrome molybdenum with plastic covered handles for grip and comfort. Includes side cutters, combination pliers, long nose pliers and water pump pliers. Supplied in the unique Teng Tools double TC tray with removable lid and dove tail joints for use on it's own or as part of the Teng Tools TC control system. (265x284x50mm, 1.8 kilos)

Side cutters	heavy duty	6", 8" (2.5mm/3.0mm piano wire cutting capacity)
Combination pliers	high leverage	6", 8" (1.6mm/2.0mm piano wire cutting capacity)
Long nose pliers		6", 8" (1.0mm/1.5mm piano wire cutting capacity)
Water pump pliers		7", 10" (25mm/38mm capacity)



TT440-T Plier set

Set of 4 Mega Bite pliers: water pump pliers, combination pliers, side cutters and long nose pliers. Chrome molybdenum steel with TPR grips. Supplied in the unique Teng Tools TC tray with removable lid and dove tail joints for use on it's own or as part of the Teng Tools TC control system. (265x142x50mm, 1.3 kilos)

TPR grip handles	6" side cutter, 7" combination, 8" long nose, 10" water pump
------------------	--



TTD441-T 8 Piece Plier Set

8 piece plier set made of chrome molybdenum with TPR grip bi-material handles for extra grip and comfort. Includes side cutters, combination pliers, long nose pliers and water pump pliers. Supplied in the unique Teng Tools double TC tray with removable lid and dove tail joints for use on it's own or as part of the Teng Tools TC control system. (265x284x50mm, 2.0 kilos)

Side cutters	heavy duty	6", 8" (2.5mm/3.0mm piano wire cutting capacity)
Combination pliers	high leverage	6", 8" (1.6mm/2.0mm piano wire cutting capacity)
Long nose pliers		6", 8" (1.0mm/1.5mm piano wire cutting capacity)
Water pump pliers		7", 10" (25mm/38mm capacity)



TTXMB02 Water Pump Plier and Adjustable Wrench Set

NEW!

Two really handy tools in one TTX tray for use on it's own or as part of the Teng Tools TC control system. The set includes the MB482-10Q Quick adjust 10" water pump plier and the 4003J 10" "Alligator" adjustable wrench with pipe grip. (570x115x40mm, 0.97 kilos).

Wrenches	10"	Alligator adjustable
Pliers	10"	Quick action water pump



WRMB04 4 Piece Plier Set

4 piece plier set. Pliers have bi-material TPR grip for added comfort and grip. Complete with a wall rack for fixing to the wall or a work bench.

Pliers	6" side cutters, 7" heavy duty combination, 8" long nose and 10" water pump
--------	---



TED441-T Plier Set

5 piece plier set. Supplied in the unique Teng Tools double width TC tray with removable lid and dove tail joints for use on it's own or as part of the Teng Tools TC control system. The tools are held in place using the Teng Tools three colour pre-cut EVA foam tool control system. (265x284x50mm, 1.75 kilos)

Pliers	5" side cutters, 6" heavy duty side cutters, 8" long nose pliers, 8" heavy duty combination pliers, 10" water pump pliers.
--------	--



TEXMB02 Water Pump Pliers & Alligator Adjustable Wrench Set

NEW!

Two really handy tools in one TTX Tray for use on it's own or as part of the Teng Tools TC control system. The set includes the MB482-10Q quick adjustable water pump plier and the 4003J 10" "Alligator" adjustable wrench with pipe grip. The tools are held in place using the Teng Tools three colour pre-cut EVA foam tool control system. (570x115x40mm, 0.97 kilos)

Wrenches	10" "Alligator" adjustable
Pliers	10" quick action water pump



TTEMB17 Plier set

Set containing 17 assorted Mega Bite pliers. Supplied in the Teng Tools three colour pre-cut EVA foam tool control system. (570x375x75mm, 4.25 kilos)

Cutting pliers	5" side cutters, 6" side cutters, 6" heavy duty side cutters, 8" heavy duty side cutters, 8" offset heavy duty side cutters, 8" cable cutters
Combination pliers	7" heavy duty combination, 8" heavy duty combination
Long nose pliers	8" long nose, 6" flat long nose
Circlip pliers	7" inner/straight, 7" inner/bent, 7" outer/straight, 7" outer/bent
Water pump pliers	7" water pump, 10" water pump
Wire strippers	7" wire stripping pliers



TTEMB11 11 piece plier set

Set containing a range of the most commonly used pliers and power grip pliers. Supplied in the Teng Tools three colour pre-cut EVA foam tool control system. (570x375x50mm, 3.3 kilos)

Side cutters	Heavy duty	8"(3.0mm piano wire cutting capacity)
Combination pliers	High leverage	7"(1.8mm piano wire cutting capacity)
Long nose pliers		8" (1.5mm piano wire cutting capacity)
Water pump pliers		10" (38mm capacity)
Circlip pliers	Inner type	7" straight and bent type (1.8mm tip, 19 to 60mm capacity)
Circlip pliers	outer type	7" straight and bent type (1.8mm tip, 19 to 60mm capacity)
Power grip pliers	long nose	6" straight jaw (35mm capacity)
Power grip pliers	regular	4" and 10" curved jaw (25mm/47mm capacity)

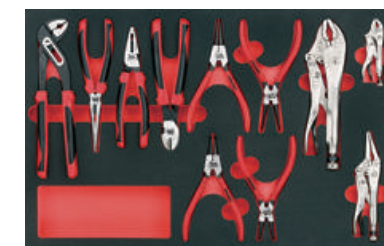

445W Plier set

A set of 5 Mega Bite pliers in a handy tool roll storage wallet.
Contents: 4 1/2" mini side cutting pliers, 6" side cutting pliers, 7" combination pliers, 8" long nose pliers and 10" water pump pliers.



Mega Bite Side Cutters

Side cutting pliers. Chrome Molybdenum steel, 80° cutting edge angle. DIN 5749.



MB441 style - TPR grip



MB442 - TPR style grip



MB441 style - vinyl grip



MB442 style - vinyl grip

Mega Bite Side Cutters →

Stock no.	Handle type	Length mm	Length inch	Cutting capacity (mm) Piano wire	Cutting capacity (mm) Hard wire	Cutting capacity (mm) Medium hardness wire	Cutting capacity (mm) Soft wire	Weight g
MB441-5T	TPR	135	5	1.5	1.8	2.3	4.0	126
MB441-5	Vinyl coated	135	5	1.5	1.8	2.3	4.0	111
MB441-6T	TPR	155	6	1.6	2.0	2.5	4.0	176
MB441-6	Vinyl coated	155	6	1.6	2.0	2.5	4.0	150

Stock no.	Handle type	Length mm	Length inch	Cutting capacity (mm) Piano wire	Cutting capacity (mm) Hard wire	Cutting capacity (mm) Medium hardness wire	Cutting capacity (mm) Soft wire	Weight g
MB442-5	Vinyl coated	140	5	1.5	1.8	2.3	4.0	180
MB442-6T	TPR	160	6	2.0	2.5	3.8	4.0	199
MB442-6	Vinyl coated	160	6	2.0	2.5	3.8	4.0	180
MB442-7	Vinyl coated	180	7	2.0	2.5	4.0	4.0	220
MB442-8T	TPR	200	8	2.5	3.0	4.0	4.0	275
MB442-8	Vinyl coated	200	8	2.5	3.0	4.0	4.0	240

MB442-7S Mega Bite Side Cutters with Return Spring

Heavy duty side cutters with return spring. Chrome molybdenum steel. 80° cutting edge angle. DIN5749



Handle	Length mm	Length inch	Cutting capacity (mm) Piano wire	Cutting capacity (mm) Hard wire	Cutting capacity (mm) Medium wire	Cutting capacity (mm) Soft wire	Weight g
Vinyl coated	18	7	2.0	2.5	4.0	4.0	250

MB442B-8T Mega Bite offset side cutters

Offset side cutting pliers. Chrome Molybdenum steel, 80° cutting edge angle. DIN 5749.



Handle	Length mm	Length inch	Cutting capacity (mm) Piano wire	Cutting capacity (mm) Hard wire	Cutting capacity (mm) Medium hardness wire	Cutting capacity (mm) Soft wire	Weight g
TPR	200	8	2.5	3.0	4.0	4.0	275

Mega Bite Cable Cutters

Cable cutting pliers for copper and aluminium cable. One hand function with pitch guard. High carbon steel.

Stock no.	Handle type	Length mm	Length inch	Cutting Capacity mm ²	Weight g
MB444-6	vinyl coated	160	6	22	181
MB444-8T	TPR	208	8	38	347
MB444-8	vinyl coated	200	8	38	322
MB444-10	vinyl coated	250	10	60	381

Mega Bite Cable Cutters →



TPR grip



Vinyl grip

MB445-10 Heavy Duty Cable cutters

Heavy duty cable cutting pliers for copper and aluminium electric cable. One hand function with pitch guard. CR-MO steel.

Handle	Length mm	Length inch	Cutting capacity cable mm ²	Weight g
vinyl coated	250	10	60	412



Heavy Duty Cutters

Chrome molybdenum steel with induction hardened cutting edges (HRC58). An 80° angled cutting edge. Return spring and locking function.

Stock no.	Handle type	Length mm	Length inch	Cutting capacity piano wire	Cutting capacity steel wire	Cutting capacity iron wire	Weight g
BC408	vinyl coated	200	8	3.6	4.0	5.2	260
BC408T	TPR	200	8	3.6	4.0	5.2	275



TPR grip



Vinyl grip

Flush Cut Pliers

Plastic cutting pliers ideal for cutting cable ties flush with the especially shaped cutting edges. Chrome Molybdenum steel suitable for cutting plastic and can be used for cutting other soft material such as lead and tin. Spring return handles with vinyl coated grips.

Stock no.	Length mm	Length inch	Weight g
MB541-5	125	5	100
MB541-6	150	6	143
MB541-7	180	7	227



Mega Bite Combination pliers

Combination pliers. With pipe grip and serrated grip surfaces. Chrome Molybdenum steel, 80° cutting angle. Vinyl grip handles. DIN 5746.

Mega Bite Combination Pliers →

Stock no.	Handle type	Length mm	Length inch	Cutting capacity (mm) Piano wire	Cutting capacity (mm) Hard wire	Cutting capacity (mm) Medium hardness wire	Weight g
MB451-7	Vinyl coated	180	7	1.8	2.0	3.8	195
MB451-8	Vinyl coated	200	8	2.0	2.2	4.0	253



Mega Bite Combination pliers

High Leverage Combination pliers. Chrome Molybdenum steel, 80° cutting angle. With pipe grip and serrated grip surfaces. DIN 5746.

Mega Bite Combination Pliers →

Stock no.	Handle type	Length mm	Length inch	Cutting capacity (mm) Piano wire	Cutting capacity (mm) Hard wire	Cutting capacity (mm) Medium hardness wire	Weight g
MB452-6T	TPR	160	6	1.6	1.8	3.4	200
MB452-6	Vinyl coated	160	6	1.6	1.8	3.4	210
MB452-7T	TPR	180	7	1.8	2.0	3.8	220
MB452-7	Vinyl coated	180	7	1.8	2.0	3.8	210
MB452-8T	TPR	200	8	2.0	2.2	4.0	266
MB452-8	Vinyl coated	200	8	2.0	2.2	4.0	240
MB452-9	Vinyl coated	225	9	2.0	2.2	4.0	380



Mega Bite Long nose pliers

Long nose pliers. Long, straight jaws. Serrated grip surfaces. Chrome Molybdenum steel, 80° cutting edge. DIN 5745.

Mega Bite Long Nose Pliers →

Stock no.	Handle type	Length mm	Length inch	Cutting capacity (mm) Piano wire	Cutting capacity (mm) Hard wire	Cutting capacity (mm) Medium hardness wire	Weight g
MB461-5	Vinyl coated	140	5	1.0	1.5	2.5	130
MB461-6T	TPR	160	6	1.0	1.5	2.5	160
MB461-6	Vinyl coated	160	6	1.0	1.5	2.5	130
MB461-8T	TPR	200	8	1.5	1.8	2.8	200
MB461-8	Vinyl coated	200	8	1.5	1.8	2.8	180



Mega Bite Bent Long Nose Pliers

Bent long nose pliers. Long, 45° angled jaws. Chrome Molybdenum steel, 80° cutting edge. DIN 5745.

Mega Bite Bent Long Nose Pliers →

Stock no.	Handle type	Length mm	Length inch	Cutting capacity (mm) Piano wire	Cutting capacity (mm) Hard wire	Cutting capacity (mm) Medium hardness wire	Weight g
MB463-5	Vinyl coated	140	5	1.0	1.5	2.5	150
MB463-6	Vinyl coated	160	6	1.0	1.5	2.5	160
MB463-8	Vinyl coated	200	8	1.5	1.8	2.8	167
MB463-8T	TPR	200	8	1.5	1.8	2.8	186



Mega Bite Flat nose pliers

Flat nose pliers. Long, straight jaws. Chrome Molybdenum steel. DIN5745.

Stock no.	Handle type	Length mm	Length inch	Weight g
MB464-6	Vinyl coated	165	6	120
MB464-6T	TPR	165	6	120



MB465-6 Round nose pliers

Chrome molybdenum alloy steel. Polished finish with smooth tip. Spring action and vinyl grip handles.

Handle type	Length mm	Length inch	Weight g
Vinyl coated	150	6	170



Long Reach pliers

11" slim jaw long reach pliers. The long reach enables the plier to reach into recessed areas. Body hardness HRC 43-48.

Stock No.	Type	Length mm	Length inch	Weight g
AT096	straight	275	11	300
AT097	45° bent	275	11	300

Long Reach Pliers →



Self Locking Pliers

Special grade stainless steel self locking pliers with a three step lock function and precision joint construction. Matt finish, hot drop forged.

Stock No.	Length mm	Jaw type	Weight g
SLP1160	160	straight, serrated	43
SLP2180	180	straight, serrated	45
SLP3160	160	curved, serrated	50
SLP3180	180	curved, serrated	58



Mega Bite Water Pump pliers

Water pump pliers. Serrated jaws with pipe grip. Chrome vanadium steel.

Stock no.	Handle type	Length mm	Length inch	Capacity mm	Weight g
MB481-7T	TPR	180	7	3-25	344
MB481-7	Vinyl coated	180	7	3-25	159
MB481-10T	TPR	250	10	3-38	371
MB481-10	Vinyl coated	250	10	3-38	175



Mega Bite Water Pump Pliers →

Quick set water pump pliers

Water pump pliers with a "quick set button" for easier adjustment of the jaws. Serrated jaws with pipe grip. Chrome vanadium steel.

Stock no.	Handle type	Length mm	Length inch	Capacity mm	Weight g
MB481-10Q	Vinyl coated	250	10	3-38	380
MB481-10TQ	TPR	250	10	3-38	405

Quick Set Water Pump Pliers →



Quick set water pump pliers NEW!

Simple to operate self-adjusting water pump pliers with one hand action. Simply position the upper jaw against the work piece and press the button to close the jaw. HRC60 hardened jaws and shaped to protect the operator's fingers.

Handle type	Length mm	Length inch	Capacity mm	Weight g
Vinyl coated	252	10	up to 49.4	335



MB499-7T Mega Bite Wire Stripping plier

Wire stripping pliers. Medium carbon alloy steel. With adjuster screw for required wire diameter 0.2-4.5 mm. Return spring and ergonomically designed two component TPR grip.

Handle type	Length mm	Length inch	Capacity mm	Weight g
TPR	155	6	0.2 to 4.5	175



498-7 Wire Cutters

7" wire cutters for cutting wire and steel cable, special cutting edge gives an even cut. Return spring mechanism and vinyl grip handles.

Handle type	Length mm	Length inch	Cutting Capacity steel wire	Cutting Capacity stainless steel	Cutting Capacity spring steel	Weight g
Vinyl coated	190	7	7mm	4mm	2.5mm	306



AT605 Wire Twisting plier

6" wire twisting side cutting plier with slim nose tip for optimum maneuverability. Cutting capacity 1.0mm stainless and inconel wire.

Length mm	Length inch	Weight g
150	6	250



End Nippers

Higher leverage end nippers. Chrome molybdenum alloy steel. Polished finish and vinyl grip handles. DIN5748.

End Nippers →

Stock No.	Length mm	Length inch	Cutting Capacity (mm) Hard wire	Cutting Capacity (mm) Medium wire	Cutting Capacity (mm) Soft wire	Weight g
MB448-6	160	6	1.6	1.8	3.4	200
MB448-8	200	8	1.6	1.8	3.4	250



Carpenter's Pliers

Carpenter's pliers with an 85° cutting angle. Vinyl coated grips.

Stock No.	Length mm	Length inch	Cutting Capacity (mm) steel wire	Cutting Capacity (mm) iron wire	Weight g
MB489-7	180	7	1.6	2.0	262
MB489-8	200	8	1.8	2.0	283



Mega Bite Tower pincer pliers

Tower pincer pliers, chrome molybdenum alloy steel, polish finish. Vinyl coated grip.

Mega Bite Tower Pincer Pliers →

Stock No.	Length mm	Length inch	Cutting capacity (mm) Hard wire	Cutting capacity (mm) Medium hardness wire	Cutting capacity (mm) Soft wire	Weight g
MB449-9	220	9	1.8	2.0	3.4	355
MB449-10	250	10	2.0	2.2	3.8	408
MB449-11	280	11	2.5	3.0	4.0	492



Mega Bite Groove Joint pliers

Heavy duty model. Groove Joint pliers. Chrome vanadium. Non slip groove joints. Polished head. Vinyl grip handles.

Stock no.	Handle type	Length mm	Length inch	Capacity mm	Weight g
MB410	Vinyl coated	250	10	45	425
MB412	Vinyl coated	300	12	60	600
MB416	Vinyl coated	400	16	90	1330

Mega Bite Groove Joint Pliers →



TTMI16 Mini plier & screwdriver set

Set containing 12 mini screwdrivers and 4 mini pliers. Supplied in the unique Teng Tools TC tray with removable lid and dove tail joints for use on it's own or as part of the Teng Tools TC control system. (265x142x50mm, 0.71 kilos)



Screwdrivers	Flat regular	2.0, 2.4, 3.0
	PH type	PH00, PH0, PH1
	TX type	TX6, TX7, TX8, TX9, TX10, TX15
Pliers	4 1/2" side cutter, 4 1/2" end cutter, 5" long nose, 5" flat nose	

MBM441 Mini Pliers

Mini Side Cutting Pliers. Spring action handles, 68° Cutting Edge, High Carbon Steel, Vinyl Coated Grip.

Length mm	Length inch	Cutting capacity mm	Weight g
125	5	0.8	67



MBM449 Mini Pliers

Mini End Cutting Pliers. Spring action handles, 68° Cutting Edge, High Carbon Steel, Vinyl Coated Grip.

Length mm	Length inch	Cutting capacity mm	Weight g
110	4 1/2"	0.8	70



MBM461 Mini Pliers

Mini Long Nose Pliers. Spring action handles, 68° Cutting Edge, High Carbon Steel, Vinyl Coated Grip.

Length mm	Length inch	Cutting capacity mm	Weight g
125	5	0.8	81



MBM464 Mini Pliers

Mini Flat Nose Pliers. Spring action handles, High Carbon Steel, Vinyl Coated Grip.

Length mm	Length inch	Weight g
125	5	85



MBM467 Mini electronics Pliers.

Spring action handles, round nose. High Carbon Steel, Vinyl Coated Grip.

Length mm	Length inch	Weight g
125	5	71



DO'S AND DONT'S OF PLIERS

- ✔ **Use the right type of cutting**
 If the plier does not cut the material without excessive force then use a stronger plier or a different type of tool. For example, standard side cutters are for cutting electrical wire not split pins.
- ✔ **Use the right type of gripping**
 Different types of pliers are designed for different types of gripping – make sure the plier selected grips securely and comfortably.
- ✔ **Use the right size of plier**
 The longer the handle the more power or torque can be applied when cutting or gripping.
- ✔ **Keep it clean and dry**
 After use always check the tools are clean and dry before putting them away, this will help to avoid problems such as corrosion and moving parts seizing or becoming tight.
- ✘ **Do not use the wrong plier**
 If the plier does not grip tightly and securely or does not cut with reasonable rather than excessive force choose another plier or tool.
- ✘ **Do not use on live electricals**
 If you have to work on electrical or electronic equipment disconnect the power supply wherever possible and always use insulated tools even if you believe that the power is off.

MBM468 Mini Needle nose Pliers.

Spring action handles, High Carbon Steel, Vinyl Coated Grip.

Length mm	Length inch	Weight g
150	6"	75



MBM469 Mini Bent Nose Pliers.

Spring action handles, High Carbon Steel, Vinyl Coated Grip.

Length mm	Length inch	Weight g
150	6"	78



Tweezers

Special grade stainless steel tweezers. Hot drop forged, matt finish.

Stock No.	Length mm	Tip type	Weight g
TW1160	160	straight, serrated	37
TW1180	180	straight, serrated	37
TW2125	125	bent, serrated	29
TW2160	160	bent, smooth jaws	42
TW2180	170	Z shaped, needle tips	35



TW1180



TW2125



TW2160



TW2180

480 Circlip Plier set

For internal and external circlips 10-50mm. Four interchangeable heads giving eight different combinations. The tips are magnetic. Return spring. Plastic covered handles.

Handles	Reversible, spring loaded handles with locking pin	
Tips (magnetic)	internal/external straight 1.2mm tips	
	internal/external straight 1.5mm tips	
	internal/external 45 degree tips	
	internal/external 90 degree tips	



TT474-5 Circlip plier set

Set consisting of 4 Mega Bite circlip pliers (2 straight tip and 2 bent tip pliers for internal and external circlips). Fitted with return spring. Supplied in the unique Teng Tools TC tray with removable lid and dove tail joints for use on it's own or as part of the Teng Tools TC control system. (265x142x50mm, 0.5 kilos)

5" Circlip pliers	inner/straight (10 to 25mm capacity)	inner/bent (10 to 25mm capacity)
	outer/straight (10 to 25mm capacity)	outer/bent (10 to 25mm capacity)



TT474-7E 7" Circlip Pliers Set **NEW!**

Set consisting of 4 circlip pliers with invisible spring design with non slip bearing steel points for heavy duty applications. Supplied in the unique Teng Tools TC tray with removable lid and dove tail joint for use on it's own or as part of the Teng Tools TC control system. (265x142x50mm, 0.924 kilos)

7" Circlip pliers	inner/straight (19 to 60mm capacity)
	inner/bent (19 to 60mm capacity)
	outer/straight (19 to 60mm capacity)
	outer/bent (19 to 60mm capacity)



Circlip Pliers **NEW!**

- Invisible return spring design
- Insert bearing steel points for heavy duty applications
- Non-slip point angle enables the ring to stick securely to the point when compressing or expanding
- Vinyl grip handles
- DIN 5254

Stock no	Length mm	Length inch	Type	Tip mm	Capacity mm	Weight g
MBE470-7	185	7"	straight/inner	1.8	19-60	150
MBE471-7	170	7"	bent/inner	1.8	19-60	150
MBE472-7	185	7"	straight/outer	1.8	19-60	170
MBE473-7	170	7"	bent/outer	1.8	19-60	170

Circlip Pliers →

TT474-7 Circlip plier set

Set consisting of 4 Mega Bite circlip pliers (2 straight tip and 2 bent tip pliers for internal and external circlips). Fitted with return spring. Supplied in the unique Teng Tools TC tray with removable lid and dove tail joints for use on it's own or as part of the Teng Tools TC control system. (265x142x50mm, 1.0 kilos)

7" Circlip pliers	inner/straight (19 to 60mm capacity)	inner/bent (19 to 60mm capacity)
	outer/straight (19 to 60mm capacity)	outer/bent (19 to 60mm capacity)



TTX474-9 Circlip plier set

4 piece Mega Bite circlip plier set consisting of 2 straight tip and 2 bent tip pliers for internal and external circlips. Fitted with return spring. Supplied in the unique Teng Tools TC tray for use on it's own or as part of the Teng Tools TC control system. (570x115x40mm, 1.5 kilos)



9" Circlip pliers	inner/straight (40-100mm capacity)	inner/bent (40-100mm capacity)
	outer/straight (40-100mm capacity)	outer/bent (40-100mm capacity)

Circlip Pliers

Snap ring pliers. Chrome vanadium. Straight/inner type. Polished head. Vinyl grip handles. Return spring. DIN 5254.

Stock no.	Handle type	Length mm	Length inch	Type	Tip mm	Capacity mm	Weight g
MB470-5	Vinyl coated	130	5	Straight/inner	1.25	10 to 25	100
MB470-7	Vinyl coated	175	7	Straight/inner	1.8	19 to 60	134
MB470-9	Vinyl coated	225	9	Straight/inner	2.25	40 to 100	160

Circlip Pliers →

Circlip Pliers

Snap ring pliers. Chrome vanadium. Bent/inner type. Polished head. Vinyl grip handles. Return spring. DIN 5254.

Stock no.	Handle type	Length mm	Length inch	Type	Tip mm	Capacity mm	Weight g
MB471-5	Vinyl coated	130	5	Bent/inner	1.25	10 to 25	100
MB471-7	Vinyl coated	175	7	Bent/inner	1.8	19 to 60	134
MB471-9	Vinyl coated	225	9	Bent/inner	2.25	40 to 100	160

Circlip Pliers →

Circlip Pliers

Snap ring pliers. Chrome vanadium. Straight/outer type. Polished head. Vinyl grip handles. Return spring. DIN 5256.

Stock no.	Handle type	Length mm	Length inch	Type	Tip mm	Capacity mm	Weight g
MB472-5	Vinyl coated	130	5	Straight/outer	1.25	10 to 25	100
MB472-7	Vinyl coated	175	7	Straight/outer	1.8	19 to 60	134
MB472-9	Vinyl coated	225	9	Straight/outer	2.25	40 to 100	160

Circlip Pliers →

Circlip Pliers

Snap ring pliers. Chrome vanadium. Bent/outer type. Polished head. Vinyl grip handles. Return spring. DIN 5256.

Stock no.	Handle type	Length mm	Length inch	Type	Tip mm	Capacity mm	Weight g
MB473-5	Vinyl coated	130	5	Bent/outer	1.25	10 to 25	100
MB473-7	Vinyl coated	175	7	Bent/outer	1.8	19 to 60	134
MB473-9	Vinyl coated	225	9	Bent/outer	2.25	40 to 100	160

Circlip Pliers →



Power grip pliers

A range of standard and tapered power grip pliers in a broad size range together with a wide range of welding power grip pliers. In both options with anti-pinch release arms.



- Self-locking with quick release gives easier use.
- Unique locking nut on the adjustment knob makes presetting the jaws possible for easier use when you frequently work with items of the same size.
- Wire cutter/crimp action integrated in the jaws.
- Manufactured of plated, chrome vanadium steel that ensures durability and strength.
- Choose between flat or rounded jaws on the most common power grip pliers.
- Some of the welding power grip pliers are fitted with pivoted clamping jaws that can hold work pieces with irregular profiles without damaging the surface.
- Choose between models with standard release arms or anti-pinch release arms.



POWER GRIP PLIERS

TTVG05 Power grip pliers

Set consisting of 5 power grip pliers : 4", 7" and 10" round jaw, 4" and 6" long nose. Supplied in the unique Teng Tools TC tray with removable lid and dove tail joints for use on it's own or as part of the Teng Tools TC control system. (265x142x50mm, 1.5 kilos)



Pliers	4" Power Grip Plier
	4" Long Nose Power Grip
	6" Long Nose Power Grip
	7" Power Grip
	10" Power Grip

TTZVG03 Power Grip Pliers NEW!

A storage tray half the size of a TTX tray with three of the most commonly used power grip pliers. Can be used on it's own or as part of the Teng Tools TC control system. (285x115x40mm, 0.56 kilos)



Pliers	4" Power Grip Plier
	4" Long Nose Power Grip Plier
	6" Long Nose Power Grip Plier

TTPSPG Welding plier set

4 piece set containing C clamp, welding, sheet metal and 6" long nose power grip pliers. Supplied in the unique Teng Tools PS tray for use on it's own or as part of the Teng Tools TC control system. (540x265x40mm, 2.3 kilos)



Power grip pliers	11" C clamp, 9" welding grip, 8" sheet metal grip, 6" long nose
-------------------	---

TTEVG11 Power grip plier set

Set containing 11 assorted power grip pliers. Supplied in the Teng Tools three colour pre-cut EVA foam tool control system. (570x375x75mm, 5.17 kilos)



Round jaw type	4", 5", 10" and 12"
Flat jaw type	10" and 12"
Long nose type	4", 6 1/2" and 9"
Clamp pliers	11" C clamp plier with swivel pad, 12" self levelling locking plier

402 Power Grip Plier set

Set of two pliers. Self locking and with release lever. With locking nut on adjustment knob for pre-setting.



Round jaw	10" power grip plier with round and flat grip (401-10)
Long nose	6" power plier with round and flat grip (404-6)

Power Grip Pliers

Power Grip Pliers, plated, round and flat grip. Chrome vanadium. wire cutter/ crimper action. Self locking and with release lever. With locking nut on adjustment knob for pre-setting.

Stock no.	Length mm	Length inch	Capacity mm	Weight g
401-4	100	4	25	75
401-5	125	5	28	180
401-7	180	7	38	345
401-10	250	10	47	514
401-12	300	12	50	680

Power Grip Pliers →

Power Grip Pliers

Power Grip Pliers, plated, serrated, flat grip. Self locking, with release lever. Chrome vanadium. With locking nut on adjustment knob for pre-setting.

Stock no.	Length mm	Length inch	Capacity mm	Weight g
401-10F	250	10	45	527
401-12F	300	12	52	693

Power Grip Pliers →

Power Grip Pliers

Long Nose Power Grip Pliers, plated. Chrome vanadium. Wire Cutter/Crimper Action. Self locking, with release lever. With locking nut on adjustment knob for pre-setting.

Stock no.	Length mm	Length inch	Capacity mm	Weight g
404-4	100	4	35	180
404-6	155	6	35	197
404-9	230	9	70	380

Power Grip Pliers →

404-6S Power Grip Pliers – Narrow Jaw

Long nose power grip pliers with a narrow jaw for easier access in confined spaces. Chrome vanadium. Wire cutter/crimper action. Self locking with non pinch one handed operation locking/release lever. With locking nut on adjustment knob for pre-setting. Overall length 160mm with a jaw width of 6mm and jaw length of 35mm, weight 185 g.

409 Oil Filter Remover Plier

Multi purpose plier 53-118mm opening. Chrome vanadium steel, drop forged jaws, heat treated and nickel plated. Suitable for removing and installing objects of many shapes. The locking system gives an excellent extra function.



Clamping Tools

Clamps

F Clamps with a fixed handle for fast action tightening and loosening

Stock No.	Span mm	Throat depth mm	Bar dimension mm	Weight Kg
CMF16	160	80	16.5x7.5	0.48
CMF20	200	100	19.5x9.5	0.9
CMF25	250	120	22x10.5	1.21
CMF30	300	140	25x12	1.80
CMF35	300	120	25x12	1.72

Clamps →



Clamps

F clamps with a 180° swivel handle for extra torque and fast action tightening and loosening. Ergonomic grip for added comfort.

Stock No.	Span mm	Throat depth mm	Bar dimension mm	Weight Kg
CMF16T	160	80	16.5x7.5	0.57
CMF20T	200	100	19.5x9.5	1.01
CMF25T	250	120	22x10.5	1.33
CMF30T	300	140	25x12	1.96
CMF35T	300	100	25x12	1.14

Clamps →



Clamps

Reinforced malleable cast iron arms, high quality profiled rail with serrations, pressure plate with bi-material handle. Protective caps on the clamping surfaces.

Stock No.	Maximum clamping Force (N)	Span Width mm	Throat Depth mm	Bar Dimensions mm	Weight g
CMD12	1961	120	60	20.0 x 5.0	430
CMD16	2648	160	80	25.0 x 6.0	750
CMD20	3922	200	100	27.0 x 7.0	1120
CMD25	4903	250	120	29.0 x 9.0	1500
CMD30	4903	300	120	29.0 x 9.0	1590
CMD30A	5393	300	140	32.0 x 10.0	2050
CMD40	5393	400	140	32.0 x 10.0	2260
CMD40A	5393	400	175	32.0 x 10.0	2330
CMD50	4903	500	120	29.0 x 9.0	1940
CMD80	4903	800	120	29.0 x 9.0	2480

Clamps →



Fast Action Clamps

For high pressure, fast action clamping. The ratchet type lever prevents over loading and resists vibration. Ergonomic clamping and release lever.

Stock No.	Maximum clamping Force(N)	Span Width mm	Throat Depth mm	Bar Dimensions mm	Weight g
CMFQ20	3432	200	100	19.5 x 9.5	1130
CMFQ25	3922	250	120	22.0 x 10.5	1500
CMFQ30	4903	300	140	25.0 x 12.0	2260
CMFQ40	5393	400	120	25.0 x 12.0	2400

Fast Action Clamps →



Clamping Tools

Quick Clamps

A quick action lever clamp with a unique design and powerful lever bar that makes it easy to apply the correct clamping force. The top mounted lever makes the clamp quick and comfortable to use, the easy release button makes it equally quick and easy to unclamp. A bi-material grip on the handle and FRP material pads help protect the working surfaces.

Stock No.	Maximum clamping Force (N)	Span Width mm	Clamping Capacity mm	Weight g
CMQL150	1780	80	150	670
CMQL300	1780	80	300	780
CMQL450	1780	80	450	900

Quick Clamps →



Quick Clamps

A quick action lever clamp with a unique design and powerful lever bar that makes it easy to apply the correct clamping force. The bottom mounted lever makes the clamp quick and comfortable to use, the easy release button makes it equally quick and easy to unclamp. A bi-material grip on the handle and FRP material pads help protect the working surfaces.

Stock No.	Maximum clamping Force (N)	Span Width mm	Clamping Capacity mm	Weight g
CMQ150	1580	85	150	580
CMQ300	1580	85	300	680
CMQ450	1580	85	450	790
CMQ600	1580	85	600	890

Quick Clamps →



TTPSPG Welding plier set

4 piece set containing C clamp, welding, sheet metal and 6" long nose power grip pliers. Supplied in the unique Teng Tools PS tray for use on it's own or as part of the Teng Tools TC control system. (540x265x40mm, 2.3 kilos)

Power grip pliers 11" C clamp, 9" welding grip, 8" sheet metal grip, 6" long nose



406 Clamping pliers

C Clamp Power Grip Pliers, plated. Chrome vanadium. Self locking, with release lever. With locking nut on adjustment knob for pre-setting.

Length mm	Length inch	Capacity mm	Throat depth mm	Throat height mm	Weight g
280	11	80	70	100	772



406-6 Clamping pliers

C clamp power grip pliers. Nickel plated. Chrome vanadium. Self locking with release lever. With locking nut on adjustment knob for pre-setting.

Length mm	Length inch	Capacity mm	Throat depth mm	Throat height mm	Weight g
172	6	0-50	40	60	235



C Clamps with Non Pinch Release Lever

C clamp power grip pliers. Nickel plated. Chrome vanadium. Self locking with non pinch one hand operation locking/ release lever. With locking nut on adjustment knob for pre-setting.

Stock No.	Length mm	Length inch	Capacity mm	Throat depth mm	Throat height mm	Weight g
406-6S	172	6	0-50	40	60	235
406S	285	11	0-80	70	100	760

C Clamps with Non Pinch Release Lever →

406P Clamping pliers

11" C Clamp Power Grip Pliers, plated with swivel pads. Chrome vanadium. Self locking, with release lever. With locking nut on adjustment knob for pre-setting.

Length mm	Length inch	Capacity mm	Throat depth mm	Throat height mm	Weight g
280	11	80	70	100	772

406-6P Clamping pliers

C clamp power grip pliers with swivel pads for holding. Nickel plated. Chrome vanadium. Self locking with release lever. With locking nut on adjustment knob for pre-setting.

Length mm	Length inch	Capacity mm	Throat depth mm	Throat height mm	Weight g
172	6	0-50	40	60	235

C Clamps with Non Pinch Release Lever

C clamp power grip pliers with swivel pads for holding. Nickel plated. Chrome vanadium. Self locking with non pinch one hand operation locking/ release lever. With locking nut on adjustment knob for pre-setting.

Stock No.	Length mm	Length inch	Capacity mm	Throat depth mm	Throat height mm	Weight g
406-6SP	172	6	0-50	40	60	235
406SP	285	11	0-80	70	100	760

C Clamps with Non Pinch Release Lever →

407 Clamping pliers

Welding Power Grip Pliers, plated. Chrome vanadium. Self locking, with release lever. With locking nut on adjustment knob for pre-setting.

Length mm	Length inch	Capacity mm	Weight g
230	9	65	580



407AS Clamping pliers

Welding power grip pliers. Nickel plated. Chrome vanadium. Self locking with non pinch one hand operation locking/ release lever. With locking nut on adjustment knob for pre-setting.

Length mm	Length inch	Gap width mm	Jaw depth mm	Weight g
270	11	90	85	855



408 Clamping pliers

Sheet Metal Power Grip Pliers, plated. Chrome vanadium. Self locking, with release lever. With locking nut on adjustment knob for pre-setting.

Length mm	Length inch	Capacity mm	Weight g
230	8	65	580



409P Clamping pliers

Self levelling 12" clamp pliers, plated. Chrome vanadium. Self locking, with release lever. With locking nut on adjustment knob for pre-setting.

Length mm	Length inch	Capacity mm	Weight g
300	12	65	580



409SP Clamping pliers

C clamp power grip pliers with swivel pads for holding. Nickel plated. Chrome vanadium. Self locking with non pinch one hand operation locking/ release lever. With locking nut on adjustment knob for pre-setting.

Length mm	Length inch	Gap width mm	Weight g
300	12	88	740



410P Machine Table Clamp

Self locking, quick release clamping pliers for holding material on machines with a swivel pad fixing point. With locking nut on adjustment knob for pre-setting.

Length mm	Clamping Heightmm	Clamp hole mm	Weight g
320	65	10.0	580



410SP Machine Table Clamp

Self locking, quick release clamping pliers for holding material on machines with a swivel pad fixing point. Non pinch, one handed operation for easier use. With locking nut on adjustment knob for pre-setting.

Length mm	Clamping Heightmm	Clamp hole mm	Weight g
230	65	4.0	580



- Lever with single hand grip for locking the snips when not in use.
- Double spring with high torsional strength, designed for frequent use.
- Soft ergonomic two component handles give more comfortable use with a safer grip.
- Hole in the handle for tool-securing when working at height, for hanging or for easy storage. Does not apply to the shorter shears.
- Gently serrated cutting edges made of chrome molybdenum steel for stable cutting with a minimal risk of sliding.
- Available in straight, straight/right or straight/left with two models for different cutting techniques. Standard or offset.
- Colour coded handles that make it easy to choose the right tin snips: left (red), straight (yellow) and right (grey).
- Available individually, but also as a set in a TT-tray that fits in the Teng Tools tool storage system.
- Designed and manufactured in high strength steel in accordance with DIN and ANSI standards for professional automotive and industrial applications.
- The induction hardened cutting edges (60–62 HRC), cut up to 1.5 mm cold rolled steel or 0.9 mm stainless steel.
- The range also comprises three pairs of short tin snips, with the same high cutting capacity as the longer models.
- Also a basic model with plastic handles in straight, straight/right and straight/left versions.



A range of high quality tinman's shears in several different designs for various application areas. In independent tests, Teng Tools tin snips have beaten other brands available on the market.



TIN SNIPS

TTDCT05 Cutting tool set

Set containing two tin snips, utility knife, scissors and a HD cable cutter. Supplied in the unique Teng Tools double TC tray with removable lid and dove tail joints for use on it's own or as part of the Teng Tools TC control system. (265x284x50mm, 2.1 kilos)

Tin Snips (491)	Straight/right
Tin Snips (492)	Straight/left
Utility knife (710N)	
Scissors (497)	
HD Cable Cutters (496)	Capacity 2AWG



Tin Snips

Tin Snips with spring loaded high leverage handles, safety lock, hanging hole and bi-material handles for comfortable cutting. CrMo steel, hot drop forged cutting blades give an increased cutting capacity of 1.5mm steel or 0.9mm stainless steel.

Stock no.	Type	Handle colour	Capacity steel mm	Capacity stainless steel mm
490	Straight	Yellow	1.5	0.9
491	Straight/Right	Grey	1.5	0.9
492	Straight/Left	Red	1.5	0.9

Tin Snips →

495 Tin Snips

Straight, long cut tin snips with serrated edges on hot drop forged blades in CrMo alloy steel induction hardened to HRC60-62 with a full cutting length of 3" giving a cutting capacity of 0.94mm for cold rolled steel and 0.53mm for stainless steel. Overall length 290mm.

Tin Snips

Tin Snips, offset type for right and left cutting. Bi-material handles for comfortable cutting. Capacity 1.5mm steel or 0.9mm stainless steel.

Stock no.	Type	Capacity steel mm	Capacity stainless steel mm
493	Off set/Right	1.5	0.9
494	Off set/Left	1.5	0.9

Tin Snips →

High Leverage Tin Snips

Tin snips with single hand grip for easy locking of the snips when not in use. High leverage action. Double spring with high torsional strength, designed for frequent use. Serrated chrome molybdenum cutting edges induction hardened to HRC60-62 for a high and consistent quality. Suitable for cutting up to 1.5mm cold rolled sheet steel. With spring and one hand operation locking lever. Overall length 10", 250mm, weight 380g.

Stock no.	Type	Handle colour	Capacity copper mm	Capacity cold rolled steel mm	Capacity hard steel mm	Capacity stainless steel mm
490W	Straight	Yellow	1.8	1.5	1.0	0.9
491W	Straight/Right	Grey	1.8	1.5	1.0	0.9
492W	Straight/Left	Red	1.8	1.5	1.0	0.9

High Leverage Tin Snips →



496 Cable Cutter

Heavy Duty cable cutter. Chrome Molybdenum alloy steel blades are hardened to help maintain the cutting edges. Compound leverage increases cutting power while reducing the cutting effort. Also included is a new quick and simple spring free automatic latch design (one hand release) providing safety and convenience. Cuts copper and aluminium electrical cables up to 12mm diameter. Bi-material handles for comfortable cutting. Drop forged.

Length mm	Capacity mm
250	12



497 Scissors

Scissors with high carbon stainless steel blade. Bi-material grip for added comfort.

Length mm	Blade length mm	Capacity soft mm
138	42.0	22.0



SR1160



SR1180



SR2180

Intricate Cutting Scissors

Special grade stainless steel. Hot drop forged and matt finish.

Stock No.	Length mm	Tip Type	Weight g
SR1160	160	straight, sharp	61
SR1180	180	straight, sharp	77
SR2180	180	straight, blunt	69
SR3160	160	curved, sharp	61



SR3160

Bolt Cutters

Hardened central cutting edge (cutting angle 30°). Compound action. Equipped with centering screw that gives increased safety when cutting. Tubular handles with plastic grips.

Stock No.	Length mm	Length inch	Capacity	Weight g
BC414	350	14"	7mm HRC15 or 4mm HRC40	1000
BC418	450	18"	8mm HRC15 or 5mm HRC40	1600
BC424	600	24"	10mm HRC15 or 6mm HRC40	2500
BC430	750	30"	13mm HRC15 or 7mm HRC40	3500
BC436	900	36"	16mm HRC15 or 8mm HRC40	5000



Bolt Cutters →

Bolt Cutter Spare Jaws

Spare jaws for Teng Tools bolt cutters.

Stock no.	Suitable for bolt cutter
BC414J	BC414
BC418J	BC418
BC424J	BC424
BC430J	BC430
BC436J	BC436



Bolt Cutter Spare Jaws →

Mega Bite Cable Cutters

Cable cutting pliers for copper and aluminium cable. One hand function with pitch guard. High carbon steel and Titanium coated joints.

Stock no.	Handle type	Length mm	Length inch	Cutting capacity cable mm ²	Weight g
MB444-6	vinyl coated	160	6	22	181
MB444-8T	TPR	208	8	38	347
MB444-8	vinyl coated	200	8	38	322
MB444-10	vinyl coated	250	10	60	381

Mega Bite Cable Cutters →

MB445-10 Heavy Duty Cable cutters

Heavy duty cable cutting pliers for copper and aluminium electric cable. One hand function with pitch guard. CR-MO steel.

Stock No.	Handle	Length mm	Length inch	Cutting capacity cable mm ²	Weight
MB445-10	vinyl coated	250	10	60	412

Heavy Duty Cable Cutters →

TF22 Pipe Cutters

For copper and brass pipe. One thin cutting wheel and two rollers. The tool has a constant length and is ideal for use in confined spaces.

Capacity
3-22mm (1/8"-7/8")

TF30 Pipe Cutters

Heavy duty cutter complete with spare blade and retractable reamer.

Capacity
3-32mm (1/8"-1 1/4")

TF2230RK Pipe Cutter Blades

2 replacement cutting wheels for the TF22 and TF30 pipe cutters.

TF76 Pipe Cutter

Pipe cutter with aluminium frame. Capacity 6 to 76mm (1/4" to 3") in thin and thick walled copper, brass and aluminium pipe, and 16 to 76mm (5/8" to 3") for plastic pipe.

TF76RK Pipe Cutter Cutting Wheels

5 replacement cutting wheels for the TF76 pipe cutter.

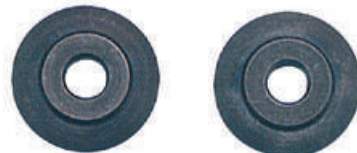
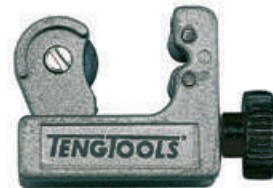

TTTC06 Pipe Cutters

6 piece set with pipe cutters for plastic, copper and brass pipes together with a deburring tool. Supplied in the unique Teng Tools TC tray with removable lid and dove tail joints for use on it's own or as part of the Teng Tools TC control system. (265x142x50mm, 1.3 kilos).

Pipe cutters	capacity (mm)	10, 12, 15, 22
Adjustable pipe cutters	capacity (mm)	3-22
Deburring tool		DET01



Pipe Cutters

Individual pipe cutters for cutting by rotating around the pipe.

Stock no.	Pipe diameter capacity (mm)
TFA10	10
TFA12	12
TFA15	15
TFA22	22
TFA0252RK	5 spare wheels



TFP01 Pipe Cutter

Cuts PEX or XLPE polyethylene tubing and other similar soft plastic piping up to 42mm diameter. Gives a right angled and burr free cut with the cutter being fed stage by stage via a ratchet mechanism.



TFP01RK Pipe Cutter Blade

Replacement cutter for TFP01 pipe cutter.



TFP02 Pipe Cutter

Cuts PEX or XLPE polyethylene tubing and other similar soft plastic piping up to 42mm diameter. Gives a right angled and burr free cut with the cutter being fed stage by stage via a ratchet mechanism.



TFP02RK Pipe Cutter Blade

Replacement cutter for TFP02 pipe cutter.



TF300 Chain Pipe Cutters

For cutting thin walled pipes (stainless steel, copper, PVC, etc.) up to a material thickness of 1.5mm. Self locking with non pinch, one hand operation lever and locking nut on adjustment knob for pre-setting. Nickel plated. The chain has 15 cutter wheels. Overall length 10", 780g.



TF300RK Replacement Cutting Chain

Repair kit for TF300 exhaust pipe cutter



TTTF10 Flaring tool set

Comprehensive tube flaring kit, suitable for copper, brass and thin walled aluminium tubing. 45° tube press flare pipes from 3/16" to 5/8" diameter. The pipe cutter can cut up to 30mm diameter. Includes spare cutting wheel inside the handle. Supplied in the unique Teng Tools TC tray with removable lid and dove tail joints for use on it's own or as part of the Teng Tools TC control system. (265x142x50mm, 1.7 kilos)



Pipe Cutter	3-32mm (1/8" - 1/4")
2 piece double flaring tool set	
Adaptors	4, 4.75 (3/16"), 6 (1/4"), 8 (5/16"), 10, 12, 14mm

DBT41 Pipe Reamer

For deburring copper, aluminium and brass pipes with cutters at both ends for internal and external deburring. For pipe diameters between 3 and 41mm. Made of plastic.



Aluminium Pipe Reamers

For deburring pipes of all types with cutters at both ends for internal and external deburring. Made of aluminium.



Stock no.	For pipe diameter
DBT35	8 to 35mm
DBT54	10 to 54mm

DET01 Deburring Tool

The HSS blade knives are swivel mounted in the handle and automatically adapt to the shape of the work piece. Use for different deburring operations on pipes, holes, edges, etc. Supplied with 2 HSS knife blades.



Stock no.	Description
DET01	Deburring tool
DET01RK	2 spare blades

DET02 Deburring Tool

The HSS blade knives are swivel mounted in the handle and automatically adapt to the shape of the work piece. Use for different deburring operations on pipes, holes, edges, etc. A handy pocket clip for added convenience.



700-PRO5 The Cutting Edge

The Cutting Edge is a special pack including the Teng Tools utility knife, junior hacksaw and 12" hacksaw.



Hacksaw frame

Professional quality steel hacksaw with ergonomically designed aluminium handle with soft rubber grip. Includes 300mm/12" HSS 24 teeth blade. A choice of settings for cutting at 45° or 90°. Overall length 395mm.

Stock no.	Type
701N1	Hacksaw frame
702	2 spare blades 24 teeth

Hacksaw Frame →



Hacksaw frame

Professionally quality steel hacksaw with ergonomically designed aluminium handle with soft rubber grip. Includes 300mm/12" HSS 24 teeth blade. A choice of settings for cutting at 45° or 90°. Overall length 395mm.

Stock no.	Type
701N	Hacksaw frame
702	2 spare blades 24 teeth

Hacksaw Frame →



Hacksaw frame

Professional quality steel hacksaw frame with ergonomically designed aluminium handle and 12" Swedish M2 HSS 24 teeth blade. Includes facilities for pre-setting at 45 degree or 90 degree cutting angle or for use as a key hole saw. Includes storage space for extra blades.

Stock no.	Type
701	Hacksaw frame
702	2 spare blades 24 teeth

Hacksaw Frame →



Mini hacksaw

Professional quality mini hacksaw frame with 6 position blade setting and complete with 3 6" hacksaw blades.

Stock no.	Type
705	Mini hacksaw frame
705-5	5 spare blades

Mini Hacksaw →

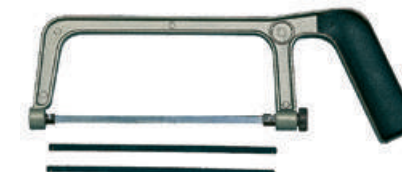

Mini Hacksaw **NEW!**

- Cast aluminium strong frame construction
- Curved shape to allow access to confined spaces
- Ergonomic rubber coated grip
- Supplied with two blades
- Complete with 6" x 24 teeth and 6-3/4" x 16 teeth hacksaw blades

Stock no	Length	Weight
705A	280	193
705A-5	6 3/4" X 16 teeth	19 5pcs(for wood)
705-5	6" X 24 teeth	19 5pcs(for metal)

Gun saw

3 piece Gun Saw set complete with 24 teeth blade for cutting metal and 10 teeth blade for cutting wood or plastic. Ergonomically designed grip with 4 position locking mechanism.

Stock no.	Type
703	3 piece Gun Saw set
703-10	10 teeth blade for cutting wood or plastic
703-24	24 teeth blade for cutting metal

Gun Saw →

704 Hacksaw holder

Hacksaw holder in plastic with a non slip handle with 12" blade. Can be used as a key hole saw.

TTDB28 28 Piece Drill Bits Set

28 piece drill bits set with a spiral angle of 28° and a split point of 118° for use on steel and cast iron. DIN 338. 265 x 142 x 50mm, 0.62 kilos

Performance	Fully Ground
Drills diameter	mm 1.0 (x3), 1.5 (x3), 2.0 (x2), 2.5 (x2), 3.0, 3.5, 4.0, 4.5, 5.0, 5.5, 6.0, 6.5, 7.0, 7.5, 8.0, 8.5, 9.0, 10.0, 10.5, 11.0, 12.0, 13.0
Shank	same as drills diameter

DB028 28 Piece Drill Bit Set

28 piece drill bit set supplied in plastic folding boxes. The spiral angle is 28° and a point angle of 118°. It has a split point for better positional accuracy. Standard drill bits for use in steel and cast iron.

Drill diameters	mm	1.0(x4), 1.5(x3), 2.0(x2), 2.5, 3.0, 3.3, 3.5, 4.0, 4.2, 4.5, 5.0, 5.5, 6.0, 6.5, 6.8, 7.0, 7.5, 8.0, 8.5, 9.0, 9.5, 10.0
No. of drills		28



6-3/4" x 16 teeth for wood

6" x 24 teeth for metal



DB034 34 Piece Drill Bit Set

34 piece drill bit set supplied in plastic folding boxes. The spiral angle is 28° and a point angle of 118°. It has a split point for better positional accuracy. Standard drill bits for use in steel and cast iron.

Drill diameters	mm	1.0(x4), 1.5(x3), 2.0(x2), 2.5, 3.0, 3.3, 3.5, 4.0, 4.2, 4.5, 5.0, 5.5, 6.0, 6.5, 6.8, 7.0, 7.5, 8.0, 8.5, 9.0, 9.5, 10.0, 10.5, 11.0, 11.5, 12.0, 12.5, 13.0
No. of drills		34

Stock No.	Size	Flute Length	Overall Length	Pack Qty
DBX010	1.0	12.0	34.0	10
DBX015	1.5	18.0	40.0	10
DBX020	2.0	24.0	49.0	10
DBX025	2.5	30.0	57.0	10
DBX030	3.0	33.0	61.0	10
DBX033	3.3	36.0	65.0	10
DBX035	3.5	39.0	70.0	10
DBX040	4.0	43.0	75.0	10
DBX042	4.2	43.0	75.0	10
DBX045	4.5	47.0	80.0	10
DBX050	5.0	52.0	86.0	10
DBX055	5.5	57.0	93.0	10
DBX060	6.0	57.0	93.0	10
DBX065	6.5	63.0	101.0	10
DBX068	6.8	69.0	109.0	10
DBX070	7.0	69.0	109.0	10
DBX075	7.5	69.0	109.0	10
DBX080	8.0	75.0	117.0	5
DBX085	8.5	75.0	117.0	5
DBX090	9.0	81.0	125.0	5
DBX095	9.5	81.0	125.0	5
DBX100	10.0	87.0	133.0	5
DBX105	10.5	87.0	133.0	5
DBX110	11.0	94.0	142.0	5
DBX115	11.5	94.0	142.0	5
DBX120	12.0	101.0	151.0	5
DBX125	12.5	101.0	151.0	5
DBX130	13.0	101.0	151.0	5

TTTD17 Tap & Die set

17 piece set containing one tap and one die of each dimension as well as a tap wrench, a die stock and a screw pitch gauge. Suitable for repairing threads. Supplied in the unique Teng Tools TC tray with removable lid and dove tail joints for use on it's own or as part of the Teng Tools TC control system. (265x142x50mm, 0.8 kilos)

Metric dies	3mm x 0.5, 4mm x 0.7, 5mm x 0.8, 6mm x 1.0, 8mm x 1.25, 10mm x 1.5, 12mm x 1.75
Metric taps	3mm, 4mm, 5mm, 6mm, 8mm, 10mm, 12mm
Accessories	tap handle (capacity 3 to 12mm), die handle with adjustment screw (capacity 3 to 12mm), screw pitch gauge

TTTD34 Tap & Die Set

34 piece tap and die set containing 7 taps, 7 dies, pitch gauge, 7 drill bits, 5 screw extractors, one mini screwdriver, adaptor, mini palm ratchet, interchangeable die chuck and two tap chucks. Supplied in the unique Teng Tools double TC tray with removable lid and dove tail joints for use on it's own or as part of the Teng Tools TC control system. (265x284x50mm, 1.6 kilos)

Metric dies	mm	3x0.5, 4x0.7, 5x0.8, 6x1.0, 8x1.25, 10x1.5, 12x1.75
Metric taps	mm	3, 4, 5, 6, 8, 10, 12mm
Drill bits	mm	2.5, 3.3, 4.2, 5.0, 6.8, 8.5, 10.5mm
Screw extractors		1/8" 3/16" 15/64" 5/16" 3/8"
Accessories		Screw pitch gauge, mini screwdriver hex (2.5x40mm), 1/4" extension bar, 3/8"F:1/4"M adaptor, 1/4" mini palm ratchet, 1/4" interchangeable die chuck, 1/4" tap chuck (x2 - M3-M8, M5-M12)



Fully Ground Drill bits

Drill bits with a spiral angle of 28° and a point angle of 118°. The drill bits have a split point for better positional accuracy. Standard drill bits for use in steel and cast iron. DIN 338.



Fully Ground Drill Bits →



CLEAR FOR TAKE OFF ACCORDING TO TENG



RUBEN, Flight Engineer

When it comes to flying you don't want to gamble. You want perfectly tuned machinery. To get that, you need a perfectly tuned workshop. For some, things organised perfectly might seem boring, but when it comes to getting clear for take-off, it's vital. Welcome to our world!



Get organised™

Individual Taps & Dies

Separate dies and taps, suitable as replacement parts for Teng Tools Tap and Die sets.

Stock No.	Size	Description
TDT03050	3mm x 0.5	Spare Tap
TDT04070	4mm x 0.7	Spare Tap
TDT05080	5mm x 0.8	Spare Tap
TDT06100	6mm x 1.0	Spare Tap
TDT08125	8mm x 1.25	Spare Tap
TDT10150	10mm x 1.5	Spare Tap
TDT12175	12mm x 1.75	Spare Tap
TDD03050	3mm x 0.5	Spare Die
TDD05080	5mm x 0.8	Spare Die
TDD04070	4mm x 0.7	Spare Die
TDD06100	6mm x 1.0	Spare Die
TDD08125	8mm x 1.25	Spare Die
TDD10150	10mm x 1.5	Spare Die
TDD12175	12mm x 1.75	Spare Die

Individual Taps and Dies →



M140070 Die chuck

1/4" drive interchangeable die chuck for use with, for example, the Teng Tools mini palm ratchet. Suitable for use with Teng Tools individual dies. Length 70mm, diameter 35mm.

Tap chucks

1/4" drive adjustable tap chucks for use with, for example the Teng Tools mini palm ratchet. Suitable for use with Teng Tools individual taps.

Stock No	Drive	For taps	Chuck diameter
M140071	1/4	3-8	20
M140072	1/4	5-12	25

Tap Chucks →



TAP-HNDL Individual Tap Handle

Individual tap handle for use with Teng Tools taps and Teng Tools screw extractors (capacity 3 to 12mm).



DIE-HNDL Individual Die Handle

Individual die handle for use with Teng Tools dies.



Teng Tools



KNIVES

Knives that are easy and efficient to use.
The right quality knives for each occasion and user.
Everyone will find their favourite among these best-sellers.



Safety knives

- The function to lock the blade in the retracted position prevents you from accidentally extending the blade and injuring yourself.
- Practical storage of 5 extra knife blades in the handle.
- Easy to change the blade – press the red button and remove the old blade, load a new blade by pressing the button at the rear of the knife.
- With comfortable two-component grip, shaped for pushing and pulling forces.

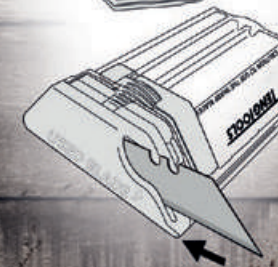
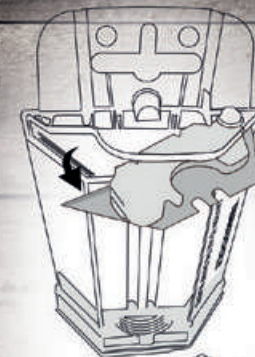

Knife blade

- Knife blade that fits all standard knives.
- Manufactured of high-alloy carbon steel, which ensures maximum sharpness and optimum durability.
- Two different sizes of packages with loose knife blades: 10-pack or 100-pack.
- Easy to store and handle loose knife blades.
- Practical dispenser with new blades and space for used blades.



Flexible, foldable knives

- Magazine that holds three blades which are easy to change – press the red button, take out the dull blade and reload with the black button at the front.
- The blade locks in the extended position, preventing the knife from being folded up unintentionally. Release with the black button.



Snap-off blade knives

- Several of these are equipped with tools that make it easy to snap off the blade.
- The five most popular models on the market.
- Two blade widths to choose from: 9 mm or 18 mm.



Get organised™

TTK40 Knife Set

A handy set of knives for different uses in one convenient set. Supplied in the unique Teng Tools TC tray with removable lid and dove tail joints for use on its own or as part of the Teng Tools TC control system. (265x142x50mm, 1.7 kilos)

Knives	utility knife with auto load function	Spare blades	5 x Regular knife blades
	folding universal knife		10 x Mini knife blades
	folding mini utility knife		10 x 9mm Snap off blades
	hobby knife with 9mm blade		10 x 18mm Snap off blades
	hobby knife with 18mm blade		



710S Knife Set

4 assorted hobby type knives with snap off blades

Snap off blade knives	9mm blade with metal body
	9mm blade with plastic body
	18mm blade with plastic body
	18mm blade with plastic body and position lock



Hobby knife

Hobby knife with 9mm blade. Metal casing with break off tool and pocket clip. Supplied with one 9mm snap off blade (spare blades available).

Stock No.	
710A	Hobby Knife
710A-10	10 spare 9mm blades

Hobby Knives →



Hobby knife

Hobby knife with 9mm blade. Plastic casing with break off tool and pocket clip. Supplied with one 9mm snap off blade (spare blades available).

Stock No.	
710H	Hobby knife
710A-10	10 spare 9mm blades

Hobby Knives →



Hobby knife

Hobby knife with 9mm blade. Supplied with 2 spare blades. Additional spare blades available.

Stock No.	
710F	Hobby Knife
710A-10	10 spare 9mm blades

Hobby Knives →



710A-100 Spare Blades

Pack of 100 replacement 9mm snap off blades.

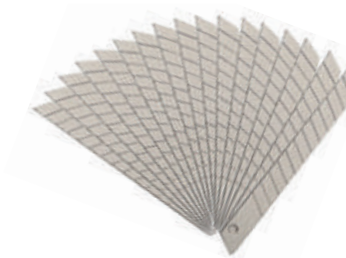

Hobby knife

Hobby knife with 18mm blade. Plastic casing with break off tool and pocket clip. Supplied with one 18mm snap off blade (spare blades available).

Stock No.	
710C	Hobby Knife
710F-10	10 spare 18mm blades

Hobby Knives →



Hobby knife with lock

Hobby knife with 18mm blade. Plastic casing with locking mechanism, break off tool and pocket clip. Supplied with two 18mm snap off blades (spare blades available).

Stock No.	
710G	Hobby Knife
710F-10	10 spare 18mm blades

Hobby Knives →



710F-100 Spare Blades

Pack of 100 replacement 18mm snap off blades.

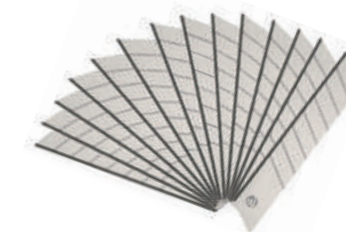

P-UKF Mini Folding Utility Knife

Folding aluminium utility knife with fixed blade. (Spare blades available)

Stock No.	
P-UKF	Utility Knife
710U-10	10 spare blades

Utility Knife →



711 Utility knife

Safety knife with bi-material plastic handle and featuring an automatic blade return that makes the knife safer to work with. When the blade has come to the end of its use, there is a handy release button at the end of the knife, one of the 6 stored blades then automatically loads into position. Also with non slip sections. Supplied with 6 blades.

Stock No.	Type
711	Utility knife
710-10	10 spare blades

Utility Knife →



712 Utility knife

Folding universal utility knife with a fixed blade. Supplied with 3 blades. Additional spare blades available.

Stock No.	Type
712	Utility Knife
710-10	10 spare blades

Utility Knife →



710 Utility knife

Heavy duty utility knife with retractable blade. Supplied complete with two spare blades.

Stock No.	Type
710	Utility knife
710-10	10 spare blades

Utility Knife →



710N Utility knife

Heavy duty utility knife with ergonomically designed handle including a non slip section for better grip. A 3 step blade adjustment. Quick opening and closing action and with spare blade storage inside handle. Supplied with 2 blades.

Stock No.	Type
710N	Utility knife
710-10	10 spare blades

Utility Knife →



710-10 Spare Blades

Pack of 10 replacement utility knife blades with storage for used blades.



710-100 Spare Blades

Pack of 100 replacement utility knife blades with storage for used blades.



710-10H Spare Blades

Pack of 10 replacement utility knife hook shaped blades with storage for used blades.



710-100H Spare Blades

Pack of 100 replacement utility knife hook shaped blades with storage for used blades.



From high tech aerospace users to your local engineering workshop, Teng Tools is used in all types of industry.

MD503N 6 and 7mm Hose Clip Driver

Reversible 6mm or 7mm fitting to suit most worm drive hose clips. Additional features include Mega Drive style handle for a more comfortable grip and a flexible spiral steel shaft for easier access (overall length 275mm).

Stock no.	Description
MD503N	Hose clip driver
MD503RK	Replacement 6/7mm socket

6 & 7mm Hose Clip Driver →



MD503NA 7mm Hose Clip Driver

7mm fitting to suit the most commonly used worm drive hose clips such as Jubilee hose clips. Additional features include Mega Drive style handle for a more comfortable grip and a flexible spiral steel shaft for easier access (overall length 275mm).



MD503ND 8mm Hose Clip Driver

8mm fitting to suit some European style worm drive hose clips and Jubilee high torque hose clips. Additional features include Mega Drive style handle for a more comfortable grip and a flexible spiral steel shaft for easier access (overall length 275mm).



TTTM03 Inspection tool set

3 piece inspection set including an inspection mirror, a magnifying glass and a magnetic pick up. All with pocket clips. Supplied in the unique Teng Tools TC tray with removable lid and dove tail joints for use on it's own or as part of the Teng Tools TC control system. (265x142x50mm, 0.5 kilos)

Telescopic magnifying glass
Telescopic inspection mirror
Telescopic magnetic pick up tool



TTTM08 Inspection tool set

Containing flexible and telescopic pick ups, magnifying glass, inspection mirror, flexible claw pick up, LED torch and batteries. Supplied in the unique Teng Tools TC tray with removable lid and dove tail joints for use on it's own or as part of the Teng Tools TC control system. (265x142x50mm, 1.1 kilos)

LED flashlight	
Flexible magnetic pick up	length 310mm
Telescopic magnetic pick up	length 160-480mm
38mm magnifying glass 1:3	with magnetic adaptor
38mm inspection mirror	with magnetic adaptor
230mm flexible claw pick up tool	
Batteries AAA (2 pieces)	



TTOS16 Oil service set

Set consisting of 6 double ended drain plug sockets, 16 and 21mm 6 point spark plug sockets, oil filter wrench, 3" and 10" wobble extension bars, 1/2"-3/8" adaptor, telescopic inspection mirror with magnet and a set of feeler gauges. Supplied in the unique Teng Tools TC tray with removable lid and dove tail joints for use on it's own or as part of the Teng Tools TC control system. (265x142x50mm, 1.8 kilos)

Accessories	3", 10" wobble extensions, 1/2"F-3/8" Male T bar adaptor, 6 point 21mm socket
Spark plug sockets	3/8" drive 16, 21mm
Drain plug set	bar, 5/16" hex x 3/8" hex, 11mm square x 12mm hex, 17mm hex x 1/2" hex, 8mm square x 3/8" square, 13mm square x 14mm hex, 8mm hex x 10mm hex
Accessories	strap type oil filter wrench, 3 in 1 telescopic inspection tool, 21 piece feeler gauge set (.005 mm - 1.0 mm)



TTSR04 Scraper set

4 piece set consisting of scraper, hooks and an awl. A multi purpose tool kit. Supplied in the unique Teng Tools TC tray with removable lid and dove tail joints for use on it's own or as part of the Teng Tools TC control system. (265x142x50mm, 0.4 kilos)

Gasket scraper	22mm wide blade, total length 245mm
Hooks & awl	curved hook, 90° hook and awl



FG21 Feeler Gauge

Professional quality feeler gauge set with removable nickel plated spring steel conical blades and locking nut. For measuring gaps and bearing play, etc. Measurement range 0.05 to 1.00mm.

Feeler gauge blades	0.05, 0.10, 0.15, 0.20, 0.25, 0.30, 0.35, 0.40, 0.45, 0.50, 0.55, 0.60, 0.65, 0.70, 0.75, 0.80, 0.85, 0.90, 0.95, 1.00mm
---------------------	--



Scraping & Removing Tools

Individual tools for scraping and removing.

Stock no.	Product	Description
MDH-S	90 degree hook	L-shape
MDH-L	Curved hook	S-shape
MDA-R	Awl	Round tip
MDA-SQ	Awl	Square tip
MD-SCR	Scraper	Width 22mm

Scraping Tools →



TTHC03 Hose clamp set

Special designed jaws to prevent internal hose linings from damage. Lightweight, easy to use and non conductive. 3 sizes to fit all types of hose. Supplied in the unique Teng Tools TC tray with removable lid and dove tail joints for use on it's own or as part of the Teng Tools TC control system. (265x142x50mm, 0.5 kilos)

Hose clamps	for hoses 1/4"-3/4", 1/4"-1 1/4", 3/4"-2 1/4"
-------------	---



Individual Hose Clamps

Special designed jaws prevents internal hose linings from damage. Lightweight, easy to handle and non conductive. 3 sizes to fit all types of hose.

Stock no.	For hoses inch
AT080	1/4-3/4
AT085	1/4-1 1/4
AT090	3/4-2 1/4

Hose Clamps →



TM149 Hook & Pick Set

Set of 4 tips, awl, hook tool, 45 and 90 degrees bent tools, aluminium handle. For detail work and scribing. Supplied in a pocket sized case with click lock. (105x60x32mm)

MD-SCR Gasket Scraper

Gasket scraper with 22mm blade for easy removal of gasket residue. With Mega Drive handle for more comfortable grip (overall length 245mm).



Spark Plug Boot Plier

- Heavy duty spark plug boot pliers with spring action handle
- Designed for removing spark plug boots without damaging the leads

Stock no.	Length mm	Weight g
SPBP20	250	297



Spark Plug Thread Cleaners

- Cleaning tool for spark plug threads in engine blocks

Stock no.	For threads
TRC1012	10x1.0 and 12x1.25
TRC1418	14x1.25 and 18x1.25



Spark Plug Sockets

6 point chrome vanadium sockets, with rubber insert. Satin finish.

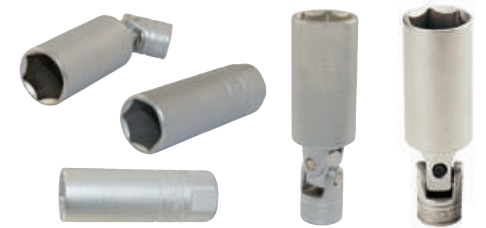

Spark Plug Sockets →

Stock No.	Drive	Description	Thread size	Length mm	Weight g
M380039-C	3/8"	6 point 14mm spark plug socket	8	64	73
M380040-C	3/8"	6 point 16mm spark plug socket	10	64	100
M380041-C	3/8"	6 point 16mm flexible spark plug socket	10	85	117
M380042-C	3/8"	6 point 18mm spark plug socket	12	70	130
M380046-C	3/8"	6 point 21mm spark plug socket	14	70	160
M380047-C	3/8"	6 point 21mm flexible spark plug socket	14	91	169
M120040-C	1/2"	6 point 16mm spark plug socket	10	70	165
M120042-C	1/2"	6 point 18mm spark plug socket	12	70	165
M120046-C	1/2"	6 point 21mm spark plug socket	14	70	165

TTXTB05 3/8" drive extra long swivel spark plug set

5 piece set with 3/8" drive extra long swivelling spark plug sockets and a T bar with handle. Supplied in the unique Teng Tools drawer width TTX tray for use on it's own or as part of the Teng Tools TC control system. (570x115x70mm, 6.5 kilos)

Spark plug sockets	14, 16, 21 mm
Accessories	2 piece T bar handle



TEXTB05 T bar Spark Plug Socket Set **NEW!**

5 piece T bar spark plug socket set supplied in the unique Teng Tools drawer width TTX tray for use on it's own or as part of the Teng Tools TC control system. The tools are held in place using the Teng Tools three colour pre-cut EVA foam tool control system. (570x115x70mm, 1.4 kilos)

Accessories	T bar handle and T bar handle adaptor
520mm long T bar spark plug sockets	14, 16, 21 mm



T bar universal joint spark plug sockets

520mm long with universal joint 6 point spark plug sockets, a T bar handle and 3/8" drive.

T bar universal joint spark plug sockets →



Stock No	Size mm	Thread mm	L mm	C mm	D mm	Weight g
TBUSBP14	14	8	520	60	10	380
TBUSBP16	16	10	520	60	10	400
TBUSBP21	21	14	520	60	10	440
T-HD01	200mm x 8mm spare bar for use with T bar universal joint spark plug sockets					

Oil Filter Wrench

Fully adjustable oil filter wrench, heavy duty strap spanner for a wide range of garage and workshop tasks. With strong, drop forged steel handle for high leverage and reinforced, rubberised non stretch strap. Capacity 160mm. Length of tool 230mm.

Stock No.	Description
9123	oil filter wrench
9123RK	oil filter wrench repair kit

[Oil Filter Wrench →](#)



409 Oil Filter Remover Plier

Multi purpose plier 53-118mm opening. Chrome vanadium steel, drop forged jaws, heat treated and nickel plated. Suitable for removing and installing objects of many shapes. The locking system gives an excellent extra function.



9124 Chain pipe wrench

Chain pipe wrench for mounting and unmounting pipes etc. Capacity of pipes 4".



TTOS16 Oil service set

Set consisting of 6 double ended drain plug sockets, 16 and 21mm 6 point spark plug sockets, oil filter wrench, 3" and 10" wobble extension bars, 1/2"-3/8" adaptor, telescopic inspection mirror with magnet and a set of feeler gauges. Supplied in the unique Teng Tools TC tray with removable lid and dove tail joints for use on it's own or as part of the Teng Tools TC control system. (265x142x50mm, 1.8 kilos)

Accessories	3", 10" wobble extensions, 1/2" F:3/8" Male T bar adaptor, 6 point 21mm socket
Spark plug sockets	3/8" drive 16, 21mm
Drain plug set	bar, 5/16" hex x 3/8" hex, 11mm square x 12mm hex, 17mm hex x 1/2" hex, 8mm square x 3/8" square, 13mm square x 14mm hex, 8mm hex x 10mm hex
Accessories	strap type oil filter wrench, 3 in 1 telescopic inspection tool, 21 piece feeler gauge set (.005 mm - 1.0 mm)



Oil Filter Removal Tool

9110. Nylon webbing strap wrench style oil filter removal tool with 1/2" drive carbon steel adaptor. Capacity 130mm.

9120. All steel chain style oil filter removal tool with 1/2" drive carbon steel adaptor. Capacity 120mm.

Stock no.	Description	Drive	Capacity mm
9110	oil filter wrench	1/2"	130
9110RK-1	replacement strap for 9110		
9120	oil filter wrench	1/2"	120
9120RK-1	replacement chain for 9120		



[Oil Filter Removal Tool →](#)

9120HD Heavy duty Oil Filter Removal Tool

Chain type oil filter removal tool with a maximum tensile strength of 1850kgf and a capacity of 150mm. 1/2" drive adaptor for use with ratchets or other socket accessories.



Drain Plug Keys

Separate plug sockets with different shapes and sizes suitable for drain plugs in engines and gearboxes.

Stock no.	Size
DP0810	8mm hex x 10mm hex
DP0812	8mm square x 3/8" square
DP1012	5/16" hex x 3/8" hex
DP1112	11mm square x 12mm hex
DP1314	13mm square x 14mm hex
DP1716	17mm hex x 1/2" hex

[Drain Plug Keys →](#)



AT005 Cylinder Leakage Tester

Two in one 14/18mm spark plug and 1/4" BSP female airline coupler. Holds most engine valves for service with the cylinder head still in place. Overall length 160mm.



AT020 Piston Ring Compressor

Piston ring compressor with 4 tightening bands suitable for cylinder diameters of 90 to 175mm. Self-locking ratchet pawl prevents premature release and allows a positive locking action. Friction proof band edge gives a smooth and accurate action.



AT040 Engine Cylinder Honing Tool

An adjustable engine cylinder honing tool suitable for cylinders from 50 to 180mm diameter. Spring tension adjustment to give a positive cutting action. Suitable for use with air tools. Grit 280.

Stock no.	Description
AT040	Engine cylinder honing tool
AT040-SM	Replacement stones (3 pieces)



Flare Nut Wrenches Range

Double Flare Nut Wrenches with different openings at each end. DIN 3118 Chrome vandium. Satin Finish.

Stock No.	Size	L	H	D1	D2	C1	C2	T	Weight
	mm	mm	mm	mm	mm	mm	mm	mm	g
641011	10x11	152.4	7.9	21.4	23.0	7.0	8.2	4.3	60
641213	12x13	178.6	10.0	25.0	27.4	9.0	10.3	5.7	113
641314	13x14	178.6	13.1	25.0	27.4	14.3	15.1	5.7	113
641617	16x17	196.0	15.1	29.9	31.9	15.4	17.0	6.4	162
641922	19x22	207.7	17.0	34.2	38.2	18.9	20.0	7.4	220

Stock No.	Size	L	H	D1	D2	C1	C2	T	Weight
	mm	mm	mm	mm	mm	mm	mm	mm	g
661416	7/16x1/2	158.8	11.9	23.0	24.3	8.2	9.0	5.5	220

[Flare Nut Wrenches →](#)



AT160 Brake Spring Washer Tool

Two in one tool that fits both large and small brake spring washers. Easy to use with a design that enables good visibility when assembling or dismantling brake assemblies. (length 230mm, weight 153g).



Disc Pad Removal Parallel Pin Punches

Parallel pin punches for removing pins from brake disc pads. Overall length 165mm.

Stock no.	Description
AT170	5.5mm parallel pin punch



AT170

AT180 Brake Cylinder Honing Tool

An adjustable brake cylinder honing tool suitable for cylinders from 20 to 68mm diameter. Spring tension adjustment to give a positive cutting action. Grit 220.

Stock no.	Description
AT180	Brake cylinder honing tool
AT180-S	Replacement stones (3 pieces)

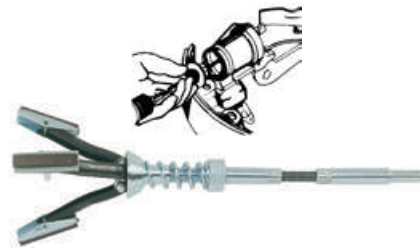

AT330 Disc Brake Pad Puller

Simply hooks on to the disc pad with 5mm pins. The sliding hammer function helps release the pad from the caliper.

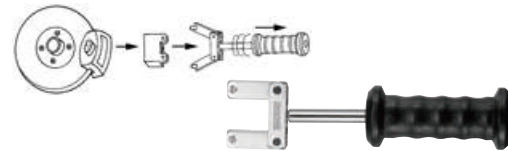

TTXPB3A Pry bar set

3 piece heavy duty pry bar set with Power Thru handles. Supplied in the unique Teng Tools TTX tray with removable lid and dove tail joints for use on it's own or as part of the Teng Tools TC control system. (570x115x70mm, 1.8 kilos)



Pry bars	12", 18", 22"
----------	---------------

Pry Bars

Heavy duty pry bar with Power Thru handles. 12", 18" and 22".

Stock No.	Size mm	Size inch
PB12A	300	12
PB18A	450	18
PB22A	550	22



PB22A



PB18A



PB12A

Pry Bars →

Ball Joint Separators

Simple to use tool for separating ball joints.

Stock No.	Opening mm	Adjustable height mm
AT186	18	38
AT191	29	60
AT192	40	80
AT194	46	100



CAPACITY 38MM OPENING 15MM

AT195 Ball Joint Separator

Heat treated drop forged steel body and thrust bolt. Fits most cars.

Stock No.	Opening mm	Adjustable height mm
AT195	16	50



AT200 Coil Spring Compressor Set

Coil spring compressor set with safety hooks. Simple to use. Capacity 250mm.



Tyre Levers

Traditional flat tyre levers manufactured in medium carbon steel (HRC 40 +/- 2°) for high leverage.

Stock No.	Size mm	Size inch
AT20512	304	12
AT20516	406	16
AT20520	508	20
AT20524	609	24

Tyre Levers →



1473 Bicycle Tool Kit

11 piece set especially designed for cyclists and including hexagon, TX and screwdriver keys, a tyre lever and a chain tool. Chrome nickel finish. Retractable in aluminium case.

Accessories	ergonomically designed aluminium holder, tyre lever and chain tool
Individual hex keys	2, 2.5, 3, 4, 5, 6mm
Individual TX keys	TX25
Individual Screwdriver keys	1.0x5.5mm flat, PH2



TEXW05 Wheel Tools Set

5 piece wheel removal tool set. Supplied in the unique Teng Tools drawer width TTX tray for use on it's own or as part of the Teng Tools TC control system. The tools are held in place using the Teng Tools three colour pre-cut EVA foam tool control system. (570x115x40mm, 2.38 kilos)

Flexible handle	1/2" drive	17" (425mm)
Wheel nut sockets	1/2" drive	17, 19, 21mm
Impact accessories	1/2" drive	5" (125mm) extension bar



Wheel Wrenches

1/2" drive extending wheel wrench complete with a choice of double ended sockets (also available individually or as a set with a 3" extension – see below). Extends from 14" (35cm) to 21" (55cm) for extra power when removing wheel nuts. Chrome vanadium steel.

Stock no.	Drive	Wheel nut socket sizes mm	Weight g
1202	1/2"	17 x 19	900
1202A	1/2"	21 x 22	905



Wheel Wrenches

STR01 Wheel Tool Set NEW!

An organised set of tools for changing wheels on cars. Includes an air gun, the most commonly used wheel nut impact sockets with nylon sleeves to protect alloy wheels. The torque wrench has four preset torque settings to suit most car applications. A handy rack is included for fixing to the wall or to a roller cabinet.

Torque wrench	1292Q401 model 1/2" drive pre-set to 90, 110 120 and 140Nm settings
Wheel nut sockets	1/2" drive deep metric with nylon sleeves - 17, 19, 21mm
Air gun	1/2" drive ARWM12M model, compact impact wrench



9203N1 Wheel Nut Set

2 double ended 1/2" drive impact sockets to fit most car wheel nuts together with an extension bar

Impact accessories	1/2" drive	3" (75mm) extension bar
Impact sockets	1/2" drive	17x19mm, 21x22mm



1/2" Drive double ended sockets for wheel nuts

1/2" drive double ended impact sockets for wheel nuts

Stock	Size mm	D1 mm	D2 mm	L mm
9291719	17/19	28	28	58
9292122	21/22	32	32	58



Wheel Nut Sockets →

9203N Wheel Nut Sockets

1/2" drive 17, 19 and 21mm deep impact sockets 6 point, metric. For wheel nuts. Made in chrome molybdenum with protective inserts for use on aluminium wheels. Black finish. Supplied as a set of three.



Wheel Nut Sockets

1/2" drive deep impact sockets 6 point, metric. For wheel nuts. Made in chrome molybdenum with protective inserts for use on aluminium wheels. Black finish.

Stock no.	Size mm	L mm	T mm	D1 mm	D2 mm	Weight g
920517N	17	85	27	26	32	260
920519N	19	85	27	29	32	270
920521N	21	85	27	29	32	380

1/2" Drive Impact Sockets →



TTTS08 Torque Stick Set

8 piece torque stick and wheel nut set, for tightening wheel nuts on cars. When the intended tightening torque is reached, the socket end stops while the drive end springs back between each stroke. Reduces the risk of sheared wheel bolts or deformed rims. Supplied in the unique Teng Tools TC tray with removable lid and dove tail joints for use on it's own or as part of the Teng Tools TC control system. (265x142x50mm, 2.0 kilos)

1/2" Torque sticks	Nm	90, 110, 120, 140
1/2" Wheel nut sockets	mm	17, 19, 21
Torque step up adaptor	inch	3/8 x 1/2



1/2" Drive Torque Sticks

1/2" drive torque sticks for tightening wheel nuts using percussive nut runners. When the intended tightening torque is reached the socket end stops while the drive end springs back between each stroke. Reduces the risk of sheared wheel bolts or deformed rims. Suitable for retaining rings and pins.

Stock No.	Drive	Torque Nm	Length mm	Retaining Ring	Retaining Pin
923090	1/2"	90	200	0935202	P90320
923110	1/2"	110	200	0935202	P90320
923120	1/2"	120	200	0935202	P90320
923140	1/2"	140	200	0935202	P90320

1/2" Drive Torque Sticks →



TTPSAD Body working hammers

Set of five body working hammers including two dead blow and three metal working hammers. Supplied in the Teng Tools PS tray for use on it's own or as part of the Teng Tools TC control system. (560x265x40mm, 4.5 kilos).

Hammers	dead blow hammers with 35 and 55mm diameter heads, crown face hammers with straight pein, pick heads and square milled face.
---------	--



Dead Blow Hammers

Dead blow hammer. Head filled with steel balls to prevent the hammer from bouncing.

Stock no.	Face diameter mm	Weight g
HMDH35	35	300
HMDH45	45	490
HMDH55	55	980
HMDH65	65	1365

Dead Blow Hammer →



Body Working Hammers

Hammers with forged alloy steel heads and mirror polished face. Hickory handle. Handle and wedge are available, order part number HMBHRK.

Stock no.	Type	Overall length mm	Weight g
HMBH01	round crown face and straight pein	325	400
HMBH02	round crown face and round point pick head for removing spots when finishing	325	350
HMBH03	round crown face and square milled face	325	400

Hammers →



HMBH01



HMBH02



HMBH03



AT415



AT420

Body Working Dollies

Individual dollies for panel beating. Use together with Teng tools body working hammers (above).

Stock No.	Shape	Length Nm	Width mm	Height mm	Weight kilos
AT415	Curved	128	58	40	1.1
AT420	Heel	80	60	30	0.9



SL01 single cup



SL02 double cup



SL03 triple cup

Suction Lifters

For easy lifting of items with large flat smooth surfaces such as glass, marble, etc. The single cup lifter can also be used to pull out dents in flat surfaces such as bodywork panels. Suction cups are 118mm diameter. The maximum load for each lifter is shown in the table below.

Stock No.	Suction cups	Maximum load kilos	Diameter of cup (mm)	Weight g
SL01	1	30	118	310
SL02	2	60	118	600
SL03	3	120	118	900

Magnetic Angle Blocks

Magnetic block used when welding sheet metal and pipes etc. in exact 90° or 45°. Can be used for both round and flat work surfaces.

Stock no.	Maximum width mm	Height mm	Magnetic force N
MH75	120	82	27
MH90	160	100	27

Magnetic Block →



Specialist Automotive Sockets

Specialist automotive sockets.

Stock No.	Drive	Size	Length mm	Applications
920242-C	1/2"	1 5/16"	78.0	Wheel nuts
920248-C	1/2"	1 1/2"	78.0	Ball Joints
920624-C	1/2"	24mm	78.0	Oil pressure switch
920627-C	1/2"	27mm	78.0	Injectors
920628-C	1/2"	28mm	78.0	Diesel Injectors
920629-C	1/2"	29mm	78.0	Thermostat switch
920630-C	1/2"	30mm	78.0	Hub nuts
920632-C	1/2"	32mm	78.0	Hub nuts/drive shafts
920635-C	1/2"	35mm	78.0	Hub nuts
920636-C	1/2"	36mm	78.0	Hub nuts
940641-C	3/4"	41mm	58.0	Hub nuts
940258-C	3/4"	1 3/16"	58.0	Deep ball joint socket
120955-C	1/2"	TX55	100	Cylinder head bolts
120970-C	1/2"	TX70	125	Cylinder head bolts
AT350	1/2"	29mm	90.0	Oxygen sensor socket
AT355	3/8"	22mm	90.0	Oxygen sensor socket
AT360	1/2"	27mm	85.0	Injector socket
AT365	3/8"	7/8"	80.0	Vacuum switch socket
AT370	3/8"	1 1/8"	74.0	Oil sender socket
AT375	1/2"	7/8"	50.0	Heated oxygen sensor socket
AT380	3/8"	7/8"	30.0	Offset Oxygen sensor socket

Specialist Automotive Sockets →



TTSS07 Specialist socket set

Specialist socket set containing 2 oxygen sensor sockets, injector socket, vacuum switch socket, oil sender socket, heated oxygen sensor socket and offset oxygen sensor socket. Supplied in the unique Teng Tools TC tray with removable lid and dove tail joints for use on it's own or as part of the Teng Tools TC control system. (265x142x50mm, 3.5 kilos)

29mm	1/2" drive	90mm in length	Oxygen sensor socket
22mm	3/8" drive	90mm in length	Oxygen sensor socket
27mm	1/2" drive	85mm in length	Injector socket
7/8	3/8" drive	80mm in length	Vacuum switch socket
1 1/8	3/8" drive	74mm in length	Oil sender socket
7/8	1/2" drive	50mm in length	Heated oxygen sensor socket
7/8	3/8" drive	30mm in length	Offset oxygen sensor socket



FC01 General - Protective wing cover

Protective wing cover with full length magnetic strip, measures 40cm x 107cm. Heavy duty red PVC front complete with the Teng eyes and cloth backing.



TTPS09 General Service Tools

9 piece tool set containing 2 adjustable wrenches, power grip pliers, utility knife, hacksaw frame, soft face hammer, measuring tape, steel rule and ball pein hammer. Supplied in the Teng Tools PS tray for use on it's own or as part of the Teng Tools TC control system. (560x265x40mm, 4.5 kilos)

General tools	6" adjustable wrench, 10" adjustable wrench, 10" power grip plier, utility knife, 12" hack saw, soft face hammer, 3 meter tape measure, 200mm steel rule, 24oz (675g) ball pein hammer
---------------	--



TTPS09E General Service Tools

9 piece tool set containing two adjustable wrenches, power grip pliers, utility knife, hacksaw frame, soft face hammer, measuring tape, steel rule and engineers hammer. Supplied in the Teng Tools PS tray for use on it's own or as part of the Teng Tools TC control system. (560x265x40mm, 4.5 kilos).

General tools	6" adjustable wrench, 10" adjustable wrench, 10" power grip plier, utility knife, 12" hack saw, soft face hammer, 3 meter measuring tape, 200mm steel rule, 800g engineers hammer.
---------------	--



SCPS01 6 Piece Service Tool Set

Service tray with 3 meter measuring tape, 12" hacksaw frame, utility knife, 10" power grip plier, 8" adjustable wrench and a 16oz ball pein hammer. Supplied in a PS tray to fit in the Teng Tools TC-SC service case (420x265x56mm, 2.5 kilos)

Measuring tape, hacksaw frame, utility knife, power grip plier, adjustable wrench, ball pein hammer.
--



SCPS01E 6 Piece Service Tool Set

Serviced tray with 3 meter measuring tape, 12" hacksaw frame, utility knife, 10" power grip plier, 8" adjustable wrench and a 500g engineers hammer. Supplied in a PS tray to fit in the Teng Tools service case. (420x265x56mm, 2.5 kilos)

Measuring tape, hacksaw frame, utility knife, power grip plier, adjustable wrench, engineers hammer.
--



TTEPS12 12 piece general service tools

Set containing a range of the most commonly used pliers and power grip pliers. Supplied in the Teng Tools 2 colour pre-cut EVA foam tool control system. (570x375x50mm, 3.34 kilos)



Cutting tools	utility knife with spare blades, 12" hack saw
Striking tools	800gm engineers hammer, soft face hammer, cold chisels (150x18mm, 200x25mm), 150x5mm centre punch, parallel pin punches (3, 4, 5, 6, 7, 8mm)
Gripping tools	6" and 10" adjustable wrenches
Measuring tools	3 meter measuring tape, 200mm steel rule

AT505 Pistol Grease Gun

One handed operation pistol style grease gun for use with bulk grease. Grease is automatically fed to the high pressure mechanism by a spring loaded low pressure piston to ensure a constant but steady flow of grease. Supplied with pipe and hydraulic coupling. Capacity 120cc.



AT500 High Leverage Grease Gun

Lever style grease gun for use with 400g cartridges or bulk grease. Grease is fed to the high pressure mechanism by fully opening the lever. Supplied with pipe and hydraulic coupling. Thread G(R) 1/8". Capacity 500cc.



TTNF12 Needle file set

Set of 12 needle files. Supplied in the unique Teng Tools TC tray with removable lid and dove tail joints for use on it's own or as part of the Teng Tools TC control system.(265x142x50mm, 0.47 kilos)

Needle files hand, half round, three square, square, round, flat pointknife type, barrette, crossing, oval, feather edge, round edge flat



TTNF12-01



TTNF12-02



TTNF12-03



TTNF12-04



TTNF12-05



TTNF12-06



TTNF12-07



TTNF12-08



TTNF12-09



TTNF12-10



TTNF12-11



TTNF12-12

Needle Files

Stock No.	Type	Length mm
TTNF12-01	Hand	160
TTNF12-02	Half round	160
TTNF12-03	Three square	160
TTNF12-04	Square	160
TTNF12-05	Round	160
TTNF12-06	Flat	160
TTNF12-07	Knife	160
TTNF12-08	Barrette	160
TTNF12-09	Crossing	160
TTNF12-10	Oval	160
TTNF12-11	Feather edge	160
TTNF12-12	Round edge flat	160

TTXF05 Hand file set

Set of 5 files, flat, hand, half round, round, three square. Supplied in the unique Teng Tools TC tray with removable lid and dove tail joints for use on it's own or as part of the Teng Tools TC control system. (570x115x40mm, 1.0 kilos)

Contains 10" files Flat, Hand, Half Round, Round, Three square



WRFL05 Wall racks - files

A set of 5 10" files including, flat, hand, half round, round and three square high carbon steel files. Complete with a wall rack for fixing to the wall or a workbench.

Sizes 10" flat file, 10" hand file, 10" half round file, 10" round file, 10" three square file

FLFT10 Flat File

10" flat type hand file, 2nd cut, cut on both edges with bi-material handle. High carbon steel.



FLHF10 File

10" hand type hand file, 2nd cut, cut on both edges with bi-material handle. High carbon steel.



FLHR10 File

10" half round type hand file, 2nd cut with bi-material handle. High carbon steel.



FLRD10 File

10" Round type hand file, 2nd cut with bi-material handle. High carbon steel.



FLTR10 File

10" triangular type hand file, 2nd cut, with bi-material handle. High carbon steel.



FLSQ10 File

10" square type hand file, 2nd cut, with bi-material handle. High carbon steel.



TT804 Puller set

Set consisting of a three legged combination puller with an extra yoke for switching to two legged pulling. With reversible legs for internal and external grip. Chrome vanadium. Supplied in the unique Teng Tools TC tray with removable lid and dove tail joints for use on it's own or as part of the Teng Tools TC control system. (265x142x50mm, 1.2 kilos)



Puller set combination twin/triple 6" leg puller with 4" capacity

Twin/Triple Leg Pullers

Triple arm pullers with a special yoke that can be easily converted for use as a twin leg puller. With reversible legs for internal/external grip.



Stock No.	Clamping Depth (mm)	Span Width mm	Weight mm
SPA11	100	50-100	1,080
SPA22	170	60-150	2,600

SP11 Gear Puller

4" Gear Puller with a spread of 76mm to 102 mm and a maximum reach of 89mm. Three legged but with a special yoke for two legged pulling.



SP22 Gear Puller

7" Gear Puller with a spread of 75mm to 175mm and a maximum reach of 137mm. Three legged but with a special constructed yoke for two legged pulling.



2 Arm universal internal/external pullers

Simple to use twin legged puller for fast removal of pulleys, wheels and bearings. Strong, drop forged design with reversible legs for use as an internal or an external puller.

2 Arm Universal Internal/External Pullers →

Stock no.	Clamping width internal (a1) mm	Clamping width external (a2) mm	Clamping depth (b) mm	Spindle thread	Spindle length mm	Spindle opening (c) mm	Claw depth (d) mm	Claw thickness (e) mm	Weight kg
SP1410	90	133	97	M14 x 1.5	140	17	12	3.4	1.1
SP1810	130	170	97	M14 x 1.5	140	17	12	3.4	1.3
SP2215	158	209	150	M20 x 2.0	210	22	20	3.8	3.2
SP2615	200	256	150	M20 x 2.0	210	22	20	3.8	3.6
SP3320	250	325	205	M26 x 2.0	280	27	27	6.2	7.8

DIS-SP05 2 Arm Universal Internal/External Puller Set

Set of five 2 legged reversible pullers complete with stand. Easily interchangeable between internal and external. Ideal for display but also for use as a set in a workshop giving a range of spreads from 90 to 250mm internal or 133 to 325mm external.

Reversible pullers	2 legged	90/133mm spread, 130/170mm spread, 158/209mm spread, 200/256mm spread, 250/325mm spread.
--------------------	----------	--



3 Arm universal internal/external pullers

Simple to use three legged puller for fast removal of pulleys, wheels and bearings. Strong, drop forged design with reversible legs for use as an internal or an external puller.

3 Arm Universal Internal/External Pullers →

Stock no.	Clamping width internal (a1) mm	Clamping width external (a2) mm	Clamping depth (b) mm	Spindle thread	Spindle length mm	Spindle opening (c) mm	Claw depth (d) mm	Claw thickness (e) mm	Weight kg
SP31410	90	133	97	M14 x 1.5	140	17	12	3.4	1.4
SP31810	130	170	97	M14 x 1.5	140	17	12	3.4	1.6
SP32215	160	211	150	M20 x 2.0	210	22	20	3.8	3.5
SP32615	205	261	150	M20 x 2.0	210	22	20	3.8	4.2
SP33320	252	327	205	M26 x 2.0	280	27	27	6.2	8.8

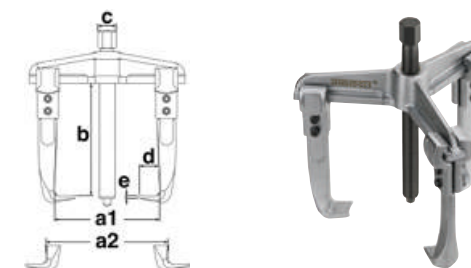

2 arm quick action internal/external pullers

Simple to use twin legged puller for fast removal of pulleys, wheels and bearings. Strong, drop forged design with reversible legs for use as an internal or an external puller. Quick lock action on the legs for fast adjustment.

2 Arm Quick Action Internal/External Pullers →

Stock no.	Clamping width internal (a1) mm	Clamping width external (a2) mm	Clamping depth (b) mm	Spindle thread	Spindle length mm	Spindle opening (c) mm	Claw depth (d) mm	Claw thickness (e) mm	Weight kg
SP1410Q	90	133	97	M14 x 1.5	140	17	12	3.4	1.1
SP1810Q	130	170	97	M14 x 1.5	140	17	12	3.4	1.2
SP2215Q	158	209	150	M20 x 2.0	210	22	20	3.8	3.0
SP2615Q	200	256	150	M20 x 2.0	210	22	20	3.8	3.4
SP3320Q	250	325	205	M26 x 2.0	280	27	27	6.2	7.0

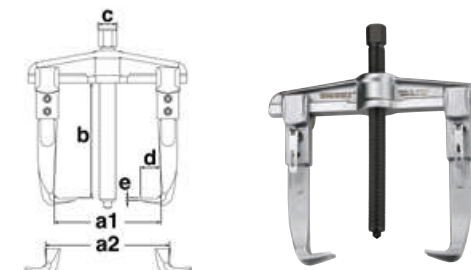



DIS-SP05Q 2 arm quick action internal/external puller set

Set of five quick action 2 legged pullers complete with stand. Easily interchangeable between internal and external. Ideal for display but also for use as a set in a workshop giving a range of spreads from 90 to 250mm internal or 133 to 325mm external.

Quick action pullers 2 legged	90/133mm spread, 130/170 spread, 158/209 spread, 200/256 spread, 250/325 spread
-------------------------------	---

3 arm quick action internal/external pullers

Simple to use three legged puller for fast removal of pulleys, wheels and bearings. Strong, drop forged design with reversible legs for use as an internal or an external puller. Quick lock action on the legs for fast adjustment.

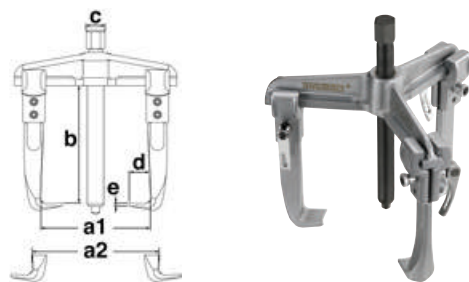

3 Arm Quick Action Internal/External Pullers →

Stock no.	Clamping width internal (a1) mm	Clamping width external (a2) mm	Clamping depth (b) mm	Spindle thread	Spindle length mm	Spindle opening (c) mm	Claw depth (d) mm	Claw thickness (e) mm	Weight kg
SP31410Q	90	133	97	M14 x 1.5	140	17	12	3.4	1.5
SP31810Q	130	170	97	M14 x 1.5	140	17	12	3.4	1.6
SP32215Q	160	211	150	M20 x 2.0	210	22	20	3.8	3.9
SP32615Q	205	261	150	M20 x 2.0	210	22	20	3.8	4.2
SP33320Q	252	327	205	M26 x 2.0	280	27	27	6.2	8.6

TTCP121 Crimping Tool Set

Set consisting of crimping tool CP50 with slots for crimping red, blue and yellow terminals and cutters for bolts and wire. Also included in the assortment are 120 terminals of varying types coloured red and blue. Supplied in the unique Teng Tools TC tray with removable lid and dove tail joints for use on it's own or as part of the Teng Tools TC control system. (265x142x50mm, 0.6 kilos)

Crimping tool	multi function CP50 crimping tool
Terminals/connectors	red #6 ring terminals x 20
	blue #8 spade terminals x 20
	red butt connectors x 20
	blue butt connectors x 20
	blue 6.3x0.8mm female connectors x 20
	blue 6.3x0.8mm male connectors x 20



TTCP04 Crimping tool set

Set consisting of ratcheting crimping tool with interchangeable heads to use on insulated, non-insulated and non-insulated barrel type connectors. Supplied in the unique Teng Tools TC tray with removable lid and dove tail joints for use on it's own or as part of the Teng Tools TC control system. (265x142x50mm, 0.8 kilos)

Changeable ratchet crimping tool	for insulated terminals 22-10 AWG (0.324 square mm ² - 5.261 square mm ²)
Die for non-insulated open barrel connector, commercial type	for non-insulated open barrel connector, commercial type 22-12 AWG (0.324 square mm ² - 3.31 square mm ²)
Die for non-insulated terminals	for non-insulated terminals 22-8 AWG(0.3 square mm ² - 8 square mm ²)
Hex key wrench	2.5mm



CP52 Crimping Plier

Interchangeable ratchet crimping tool with an automatic locking mechanism to ensure a consistent and correct crimping action. Suitable for roll crimping and both insulated and non-insulated terminals and connectors. Capacity 1.5 to 6mm² insulated and 1.5 to 2.5 mm² non-insulated terminals and connectors. Cutting edge for M2 to M5 bolts. Overall length 225mm.



Spare Heads

Spare heads for CP52 type ratcheting crimping pliers.

Stock No.	For insulated terminals mm ²	For non insulated terminals mm ²
CP04RK1	0.324 - 5.261	
CP04RK2		0.324 - 3.31
CP04RK3	0.3 - 8.0	

CP58 Crimping plier

Precision, ratcheting crimping pliers with ergonomic bi-material handles. A compound action gives 30% extra strength. Suitable for red, blue and yellow insulated terminals. Capacity 0.75 to 6.0mm, 22-10 AWG. Overall length 250mm, weight 560g.



CP50 Crimping and Wire Stripping Tools

Professional quality 9" crimping plier and wire stripper, suitable for Crimping insulated terminals from 0.75 to 6mm Crimping non insulated terminals from 1.5 to 6mm. Screw bolt cutting from M2 to M5 Stripping wire from 0.75 to 6mm.

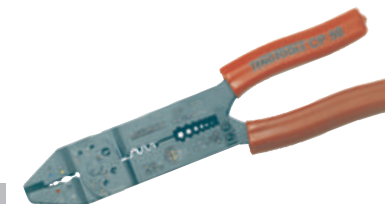

CP51 Crimping and Wire Stripping Tool

Professional quality 9" crimping plier and wire stripper, suitable for crimping insulated terminals from 0.75 to 6mm crimping non insulated terminals from 0.5 to 2.5mm (push on type), screw bolt cutting from M2 to M5 on a stripping wire from 0.75 to 6mm.



9850 General - Auto Electricians Circuit Tester

Brass 6-24 volt DC tester with steel probe and screw on cover, 830mm cable with alligator clip. Simple to use. For replacement bulb use a 24V 5 Watt Festoon type bulb. Order stock code 9850RK for the repair kit.



MDV9855 Voltage Tester

Insulated voltage tester for use from 100 to 250 volts. Overall length 145mm, blade length 70mm



CTG01 Cable Tie Gun

Ideal for repeated operations, works with plastic cable ties from 2.2 to 4.8mm in width. Adjustable tensile strength to avoid over-tightening and automatic cable tie cut off. Weight 320g.



MB499-7T Mega Bite Wire Stripping plier

Wire stripping pliers. Medium carbon alloy steel. With adjuster screw for required wire diameter 0.2-4.5 mm. Return spring and ergonomically designed two component TPR grip.



Handle type	Length mm	Length inch	Capacity mm	Weight g
TPR	155	6	0.2 to 4.5	175

MBV499-7 Insulated Wire Stripping Pliers

Insulated Mega Bite wire stripping pliers. Spring action. Chrome Molybdenum steel 80° cutting edge angle and Titanium coated joints. Produced and tested according to the EN 60900 standard. Approved for live working up to 1000 volt AC.



Length mm	Length inch	Cutting capacity (mm) Piano wire	Weight g
155	6	0.2 to 4.5	175

CP55 Wire stripping tool

Easy to use wire strippers with a hardened SK5 blade for fast and accurate stripping of wire gauges 24-10AWG or 0.2 to 6mm² wire. A handy built in cutter cuts wire up to 2mm diameter. Overall length 190mm, 130g.



CP53 Wire stripping plier

Professional wire stripping pliers for crimping terminals, stripping cables and cutting copper wire. With return spring and locking lever. Stripping capacity 0.8 1.0 1.3 1.6 2.0 2.6 3.2mm, 20-8 AWG. Cutting capacity 1.0mm copper cable. Overall length 180mm, weight 140g.



CP60 Wire stripping plier

Automatic cable strippers, wire cutters and crimping pliers. Easily strips cables between 0.13mm and 8.0mm². Suitable for insulated and non insulated terminals 0.5 to 6.0mm. With return spring and bi-material grips. Overall length 210mm, weight 342g.



TTSN11 Extractor set

Combined set of 5 screw extractors, 4 bolt extractors and 2 nut splitters. Supplied in the unique Teng Tools TC tray with removable lid and dove tail joints for use on it's own or as part of the Teng Tools TC control system. (265x142x50mm, 1.3 kilos)

Stud extractors	1/2" drive	6, 8, 10, 12mm
Screw extractors	7/64" 9/64" 5/32" 1/4" 19/64"	
Nut splitters	5 to 20mm, 14 to 27mm	



SE05 Screw Extractors

5 screw extractors supplied in a handy storage case to fit drill sizes: 7/64", 9/64", 5/32", 1/4", 19/64".



TMSE05S Screw Extractors

Set with 5 extractors for quick and easy extraction of broken screws, pipes and stud bolts. Suitable for use with both clockwise and anti-clockwise threads. Square shank. Hardened to HRC 50-52. Sizes for drill holes 3, 4, 5, 7 and 9mm. Supplied in plastic box with snap lock and metal pin hinges.



Screw Extractors

Separate screw extractors with a square shank. For a quick easy way to remove broken screws, pipes, bolts and studs. HRC50-52. Suitable for use with both clockwise and anti-clockwise threads.

Stock No.	For drill hole mm	Weight g
SEL01S	3mm (1/8")	13
SEL02S	4mm (3/16")	22
SEL03S	5mm (15/64")	36
SEL04S	7mm (5/16")	52
SEL05S	9mm (3/8")	148

Extractors →



NS02 2 piece Nut Splitter Set

Set of 2 nut splitters with capacities of 5 to 20mm and 14 to 27mm.

Stud Extractors

Reversible. Hexagon drive end and 1/2" drive.

Stock No.	Drive	Size mm
ST12506-C	1/2"	6
ST12508-C	1/2"	8
ST12510-C	1/2"	10
ST12512-C	1/2"	12

Extractors →



TTBE18 3/8" & 1/2" Drive Stud Extractor set

3/8" drive (6-17mm) and 1/2" drive (19-25mm) stud extractor sockets plus a 4mm parallel pin punch. Chrome vanadium, satin finish. Supplied in the unique Teng Tools TC tray with removable lid and dove tail joints for use on it's own or as part of the Teng Tools TC control system. (265x142x50mm, 1.5 kilos)

3/8" stud extractors	mm	6, 8, 10, 11, 12, 13, 14, 16, 17mm
	AF	5/16" 3/8" 7/16" 1/2" 9/16" 5/8"
1/2" stud extractors	mm	19, 21, 22, 24, 25mm
	AF	3/4" 13/16", 7/8" 15/16" 1"
Parallel pin punch		4mm, 150mm length



3/8" Drive Stud Extractors

3/8" drive stud extractor sockets, chrome vanadium, satin finish. Designed for removing rounded or damaged bolt heads or nuts

Stock No.	Size mm	Size AF	L mm	T mm	D1 mm	D2 mm	Weight g
ST38306	6	1/4"	27.0	11.0	15.9	9.9	21
ST38308	8	5/16"	27.0	11.0	15.9	12.0	23
ST38112	-	3/8"	27.0	11.0	15.9	14.2	22
ST38310	10	-	27.0	11.0	19.0	15.3	33
ST38311	11	7/16"	27.0	11.0	19.0	15.6	33
ST38312	12	-	27.0	11.0	19.0	17.4	33
ST38116	-	1/2"	27.0	11.0	19.0	17.7	34
ST38313	13	-	27.0	11.0	19.0	18.7	35
ST38314	14	9/16"	27.0	11.0	22.2	20.7	50
ST38316	16	5/8"	27.0	11.0	22.2	22.1	50
ST38317	17	-	27.0	11.0	25.4	24.8	74
ST38122	-	11/16"	27.0	11.0	25.4	24.8	74

3/8" Drive Stud Extractors →



1/2" Drive Stud Extractors

1/2" drive stud extractor sockets, chrome vanadium, satin finish. Designed for removing rounded or damaged bolt heads or nuts

Stock No.	Size mm	Size AF	L mm	T mm	D1 mm	D2 mm	Weight g
ST12319	19	3/4"	44.5	11.0	27.0	26.6	167
ST12321	21	13/16"	44.5	12.5	32.0	28.0	199
ST12322	22	7/8"	44.5	12.5	35.0	30.7	210
ST12324	24	15/16"	44.5	12.5	36.0	32.4	210
ST12325	25	1"	44.5	12.5	36.0	33.4	214

1/2" Drive Stud Extractors →



2300 Extractor

1/2" drive stud extractor. For inserting and extracting stud bolts. One eccentric journaled, knurled wheel grips against an internal fluting. Ranging from 5.5mm to 19mm.



Claw Pick Up Tools

Flexible wire with non magnetic claws. Press action to expand and contract. Excellent for reaching small items lost in hidden areas. Overall length 600mm. Also available with a claw and magnetic pick up as stock number AT135M.

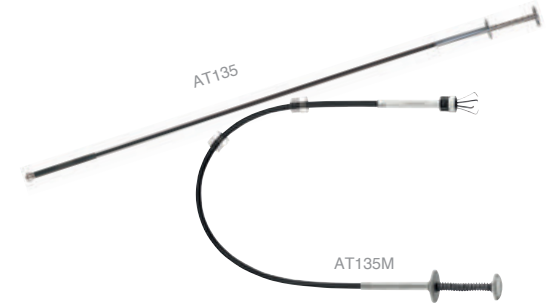

TTXPB3 Pry bar set

3 piece pry bar set consisting of 12", 16" and 20" bars. Supplied in the unique Teng Tools TTX tray for use on it's own or as part of the Teng Tools TC control system. (570x115x40mm, 1.8 kilos)



Roll/heel bars 12", 16", 20"

TEXPB4 Pry Bar Set

4 piece set including three roll/heel bars and a 20" tyre lever. Supplied in the unique Teng Tools drawer width TTX tray for use on it's own or as part of the Teng Tools TC control system. The tools are held in place using the Teng Tools three colour pre-cut EVA foam tool control system. (570x115x40mm, 2.38 kilos)



Roll/heel bars 12", 16", 20"
Tyre lever 20"

Roll/heel bars

Individual roll/heel bars.

Stock No.	Size inch	Size mm
PB12	12	300
PB16	16	400
PB20	20	500



Roll/Heel Bars →

TTXPB3A Pry bar set

3 piece heavy duty pry bar set with Power Thru handles. Supplied in the unique Teng Tools TTX tray for use on it's own or as part of the Teng Tools TC control system. (570x115x70mm, 1.8 kilos)



Pry bars 12", 18", 22"

Pry Bars

Heavy duty pry bar with Power Thru handles. 12", 18" and 22".

Stock No.	Size mm	Size inch
PB12A	300	12
PB18A	450	18
PB22A	550	22



Pry Bars →

SSH01 Safety wire

Safety wire for securing tools when working at heights. Locking wire with spring hook and plastic covered (3.0mm diameter) stainless steel (1.0mm diameter) spiral wire. Maximum load 3.0 kilos, stretches from 430mm to 1.6meters. Weight 68g.



SSH02 Safety Wire

Safety wire for securing tools when working at heights. Locking wire with spring hook and strength webbing with an elastic inner core. High strength nylon. Maximum load 3.0 kilos. Stretches from 750mm to 1.35 meters. Weight 109g.



SSH03 Safety Wire

Safety wire for securing tools when working at heights. Locking wire with spring hook and strength webbing with an elastic inner core. High strength nylon. Maximum load 4.5 kilos. Stretches from 800mm to 1.35 meters. Weight 112g.



SSH04 Safety Wire

Safety wire for securing tools when working at heights. Supplied with an adjustable rope lock on one end. Locking wire with spring hook and strength webbing with an elastic inner core. High strength nylon. Maximum load 4.5 kilos. Stretches from 860mm to 1.45 meters. Weight 94g.



580 Magnetic Bits Tray

Stainless steel tray with plastic enclosed magnet which does not damage the car paintwork. For screws, nuts and washers, etc. Can be secured on its side as well as upside down. Ideal for working under cars, etc.



580S Magnetic Bits Tray

An extra large stainless steel magnetic tray (295x270x42mm) with rubber protected magnets to avoid damage to paintwork. Can be secured on its side as well as upside down. Ideal for working under cars or by machinery or as a parts washing tray.



580A Magnetic Bits Tray

A large stainless steel magnetic tray with two rubber protected magnets to avoid damage to paintwork. The tray is deep to give extra space to store parts and more bulky items even upside down.



582MI 3 in 1 Inspection Tool

Three in one telescopic inspection tool with maximum extension of 57cm combining a very strong magnet with a fully adjustable polished mirror and an etching scribe, all in one tool with pocket clip.



585MP 2 in 1 Magnetic pick up pen

Two in one telescopic pick up with maximum extension of 63cm and a very powerful magnet plus a pen all in one handy tool with pocket clip. Ideal for retrieving dropped nuts and bolts and writing notes.



TTM03 Inspection tool set

3 piece inspection set including an inspection mirror, a magnifying glass and a magnetic pick up. All with pocket clips. Supplied in the unique Teng Tools TC tray with removable lid and dove tail joints for use on it's own or as part of the Teng Tools TC control system. (265x142x50mm, 0.5 kilos)

Telescopic magnifying glass
Telescopic inspection mirror
Telescopic magnetic pick up tool



581TMG Magnifying glass

Telescopic magnifying glass with maximum extension of 85cm and fully adjustable head and pocket clip.



581TMI Telescopic mirror

Telescopic mirror with maximum extension of 85cm and fully adjustable head and pocket clip. Mirror diameter 57mm.



581TMP Magnetic pick up

Telescopic magnetic pick up with extra strong magnet and maximum extension of 85cm and pocket clip.



SD501 Magnetic pick up

With maximum extension of 55cm and a very powerful magnet, ideal for retrieving dropped nuts and bolts.



TC-MAG Magnetic Tool rail

6 individual magnets each with a capacity of 450 grams combined in a rail especially designed for fixing to Teng Tools roller cabinets, also suitable for wall mounting or other tool boxes. Ideal for hanging up tools while working. (457x52x17mm, 0.6 kilos)



583M Bracelet with Magnetic Disc

An adjustable 340mm length bracelet with a magnetic disc – ideal for holding fastenings or nails, etc in easy reach when working.

TTM08 Inspection tool set

Containing flexible and telescopic pick ups, magnifying glass, inspection mirror, flexible claw pick up, LED torch and batteries. Supplied in the unique Teng Tools TC tray with removable lid and dove tail joints for use on it's own or as part of the Teng Tools TC control system. (265x142x50mm, 1.1 kilos)

LED flashlight	
Flexible magnetic pick up	length 310mm
Telescopic magnetic pick up	length 160-480mm
38mm magnifying glass 1:3	with magnetic adaptor
38mm inspection mirror	with magnetic adaptor
230mm flexible claw pick up tool	
Batteries AAA (2 pieces)	



587M Flexible, magnetic LED light

Flexible LED light with a magnet, supplied with 3 LED diodes. Suitable battery type LR44 (x3).

Total length	mm	370
Diameter	mm	25
Light	lumen	76.5
Power	W	0.0009
Weight	g	67



587H Magnifying Glass

Hand held magnifying glass with 14 LED bulbs in a ring around the glass to give excellent illumination. Requires 2 AAA batteries (not included). Mains adaptors also available.

Magnification	times	3
Glass diameter	mm	100
LED bulb output	watts	1.3
Luminous flux	lumen	72



Jimmy de Ville travelled all round the world to create the Discovery Channel TV programme Engine Addict - from Sweden to South America, making crazy machines from classic engines such as this snow mobile powered by a FSO Syrena engine famous for having just seven moving parts.

587J LED light bar

A 255mm wide light bar with magnetic attachment for use with work bench panels or tool boxes. 9 white LED lights with 120° distribution angle. Requires 3 x AA batteries (not included).

Length	mm	255
Width	mm	40
Height	mm	29
Light	lumen	20
Magnetic pull	Nm	30 x 2 (approx.)
Weight	g	188



586 Flexible Light

A flexible, adjustable light with a magnet on the end. Ideal for use in confined spaces and retrieving items from hard to reach places. Requires 2 x AA batteries (not included).

Total length	mm	595
Flexible length	mm	400
Outside diameter	mm	10
Maximum magnetic force	g	750



586A Head Lamp

A Cree LED head lamp with two modes – steady or flashing. Requires 3 x AA batteries, not included.

Width	mm	50
Height	mm	50
Length	mm	55
Luminous flux	lumen	250
Weight	g	110



586C Head Lamp

A Cree LED head lamp with two modes – high beam or low beam. Requires 3 x AAA batteries, not included.

Width	mm	50
Height	mm	50
Length	mm	55
Luminous flux	lumen	250
Weight	g	110



585 LED Torch

LED torch with satin chrome plated brass body. 25-30 lumen. 45 degree light distribution. 2 batteries type AAA give up to 5.5 hours average usage with constant strength. Batteries not included.



581N CREE LED Torch

CREE LED torch with shockproof aluminium body and water resistance to IPX6. Batteries not included. Overall length 135mm, diameter 23mm.



582N CREE LED Torch

CREE LED torch with shockproof aluminium body and water resistance to IPX6. Low battery indicator light shows red when less than 15% remains. Batteries not included. Overall length 138mm, diameter 40mm.



583N CREE LED Torch

CREE LED torch with shockproof aluminium body and water resistance to IPX6. Low battery indicator light shows red when less than 15% remains. Batteries not included. Overall length 195mm, diameter 40mm.



KP01 Kneeling Pad

Handy mechanics kneeling pad made in hard wearing 30.5mm thick EVA material. Ideal for protecting the knees whenever you need to kneel on a hard surface. Measures 450x210mm.



KP02 Kneeling Pad

Handy mechanics kneeling pad made in hard wearing 30.5mm thick EVA material. Ideal for protecting the knees or the back whenever you need to kneel or lie on a hard surface. Measures 880 x 300mm.

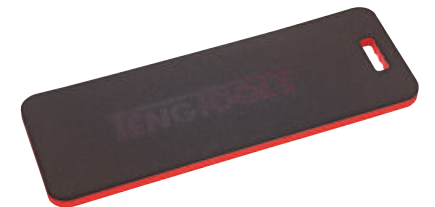

KP03 Kneeling Pad

Handy mechanics kneeling pad made in hard wearing 30.5mm thick EVA material. Individual cut out areas are included for putting small components, fastenings or tools. Ideal for keeping organised and for protecting the knees whenever you need to kneel on a hard surface. Measures 480x320mm.



TCA06 Mechanics Chair

A mechanic's stool with adjustable height and swivel castors plus a handy storage shelf. Spare castors available (stock no TCA06RK, code no 18625-1005)

Seat cushion diameter	mm	360
Storage area	mm	310x310
Adjustable height	mm	420-500
Weight	kg	6.3



TCA07 Mechanics Creeper

A stable and comfortable workshop creeper with sturdy wheels and recesses in the frame for the elbows to make it more comfortable to use.

Width	mm	500
Height	mm	155
Length	mm	1,050
Weight	kg	8.5



Ball Pein Hammers

Ball pein hammers with fibre glass shaft.

Stock no.	Head weight oz	Overall weight g	Head diameter mm	Overall length mm
HMBP12	12	550	28	280
HMBP16	16	600	30	320
HMBP24	24	1040	35	380
HMBP32	32	1280	39	380



Ball Pein Hammers →

Engineers Hammers

Engineers style hammers with fibre glass shafts.

Stock no.	Head weight g	Overall weight g	Overall length mm
HMEG300	300	420	300
HMEG500	500	650	320
HMEG800	800	1,000	350



Engineers Hammers →

Claw Hammers

Top quality 16oz claw hammer with steel tube and perforated rubber grip.

Stock no.	Head weight oz	Overall weight g	Head diameter mm	Overall length mm
HMCH08A	8	394	21.6	290
HMCH13A	13	552	27.0	335
HMCH16A	16	700	27.0	312
HMCH20A	20	765	30.0	340



HMCHM16 Shock Absorbent Carpenters Hammers

One piece forged steel claw hammer with shock absorbent grip to reduce vibration when striking. A hanging hole on the side of the handle can be used to secure the hammer (with a Teng Tools safety wire or similar) to prevent the hammer being dropped when working at height.

Stock no.	Head weight oz	Overall weight g	Head diameter mm	Overall length mm
HMCHM16	16	723	29	333



HMCHC16 Carbon Fibre Handle Carpenters Hammers

Claw hammer with a carbon fibre core in the handle to give up to 25% more "bend" in the hammer when striking. A hanging hole on the side of the handle can be used to secure the hammer (with a Teng Tools safety wire or similar) to prevent the hammer being dropped when working at height.

Stock no.	Head weight oz	Overall weight g	Head diameter mm	Overall length mm
HMCHC16	16	686	28	327



HMCH16M Magnetic Claw Hammers

Carpenters claw hammer with magnetic nail holder in the head. Chrome, oval steel handle with perforated rubber grip, a round face and an octagonal throat. A hanging hole on the side of the handle can be used to secure the hammer (with a Teng Tools safety wire or similar) to prevent the hammer being dropped when working at height.

Stock no.	Head weight oz	Overall weight g	Head diameter mm	Overall length mm
HMCH16M	16	678	27.5	341



Soft Face Hammer

Top quality rubber and soft face hammer with tubular steel shaft with perforated rubber handle. For where no surface marking is required.

Stock no.	Weight kilos	Overall length mm
HMSF	0.67	320
HMSFRK	Replacement heads for HMSF soft face hammer	

Soft Face Hammer →



HMBH16 Brick Layer/Masonry Hammers

Ideal for cutting, cleaning and setting bricks, stone or masonry. A hanging hole in the handle can be used to secure the hammer (with a Teng Tools safety wire or similar) to prevent the hammer being dropped when working at height.

Stock no.	Head weight oz	Overall weight g	Head diameter mm	Overall length mm
HMBH16	16	733	23	291



HMS1250 Lump Hammers

A 3 1/2lb (overall weight) club or lump hammer with bi-material grip. A hanging hole in the handle can be used to secure the hammer (with a Teng Tools safety wire or similar) to prevent the hammer being dropped when working at height.

Stock no.	Head weight g	Overall weight g	Head diameter mm	Overall length mm
HMS1250	1,250	1,609	43	296



WCS04L Carpenters Chisel Set

A 4 piece chisel set, finely ground and lacquer coated for corrosion protection. Impact resistant soft grip handles with percussion caps. Each chisel has a plastic blade cover. Supplied in a handy storage/carrying case. Includes 6, 12, 18 and 25mm chisels. Overall weight 1.6 kilos.



WCS04S Carpenters Chisel Set

A 4 piece chisel set, finely ground and lacquer coated for corrosion protection. Impact resistant soft grip handles with percussion caps. Each chisel has a plastic blade cover. Supplied in a handy storage/carrying case. Includes 10, 16, 18 and 20mm chisels. Overall weight 1.6 kilos.



WRWC07 Carpenters Chisel Set

A 7 piece chisel set, finely ground and lacquer coated for corrosion protection. Impact resistant soft grip handles with percussion caps. Each chisel has a plastic blade cover. Supplied with a Teng Tools wall rack for fixing to tool panels or the wall. Includes 6, 10, 12, 16, 18, 20 and 25mm chisels. Overall weight 1.7 kilos.



Wood Chisels

Professional quality wood chisels, finely ground and lacquer coated for corrosion protection. Impact resistant soft grip handles with percussion caps. Each chisel has a plastic blade cover

Stock no.	Blade width mm	Overall length mm	Weight g
WCC06	6	276	157
WCC08	8	276	159
WCC10	10	276	171
WCC12	12	276	183
WCC14	14	276	179
WCC16	16	276	195
WCC18	18	276	200
WCC20	20	276	212
WCC22	22	276	224
WCC25	25	281	229
WCC32	32	291	289
WCC38	38	305	340



WCC12



WCC18



WCC25

TTPC09 Punch & chisel set

Combined 9 piece set containing 6 punches, 2 cold chisels and a centre punch. Supplied in the unique Teng Tools TC tray with removable lid and dove tail joints for use on it's own or as part of the Teng Tools TC control system. (265x142x50mm, 1.4 kilos)

	Type	Length mm	size(s)
Punches	centre	150mm	5mm
	parallel	150mm	3, 4, 5, 6, 7, 8mm
Cold chisels	flat	150mm	19mm
		200mm	25mm



TEDPC14 Punch and Chisel Set

14 piece set including parallel pin punches, centre punch and cold chisels. Supplied in the unique Teng Tools double width TC tray with removable lid and dove tail joints for use on it's own or as part of the Teng Tools TC control system. The tools are held in place using the Teng Tools three colour pre-cut EVA foam tool control system. (265x284x50mm 2.71 kilos)

150mm parallel pin punches	3, 4, 5, 6, 7, 8mm
Flat chisels	19x150, 25x200, 25x250, 26x240mm
150mm centre punches	4, 5, 8mm, automatic centre punch



WRPC10 Punch and Chisel wall rack set

A 10 piece punch and chisel set including parallel pin punches, a centre punch and cold chisels. Complete with a wall rack for fixing to the wall or a work bench.

	Type	Length mm	size(s)
Punches	centre	150mm	5mm
	parallel	150mm	3, 4, 5, 6, 7, 8mm
Cold chisels	flat	150mm	19mm
		200mm	25mm
		250mm	25mm



PCX05 Punch and Chisel set

A 5 piece set including an 18 x 150mm flat cold chisel, a 5 x 150mm centre punch and three parallel pin punches 3, 4 and 5mm. Supplied in a handy holder.



Cold Chisels

Special steel flat cold chisels, hardened for long life.

Stock No.	Type	Size mm	Length mm
CC150F	Flat cold chisel	18	150
CC200F	Flat cold chisel	25	200
CC250F	Flat cold chisel	25	250
CC240F	Flat cold chisel	26	240

Chisels →



Safety Hand Grip For Cold Chisels **NEW!**

- Heavy moulded impact absorbing hand protection grip
- Made from TPR
- Protective plate offers improved safety for the hand against impacts
- Ergonomic design
- Avoids injuries to the hand
- Universal protective hand guard for use with Teng Tools 200, 240 or 250mm cold chisels.

Stock No.	Code no	Length mm	Width mm	Weight g
PCCAP	24566-0105	120	56	45



LIKE CLOCKWORK ACCORDING TO TENG



ANNA, Maintenance Engineer

Production stops make for a bad day. You want the manufacturing process to flow like it should. To get that, you need a perfectly tuned workstation. For some, things organised perfectly might seem boring, but when it comes to get things to run like clockwork, it's vital. Welcome to our world!



Get organised™

PPS06 Punch Set

A set of six 150mm high carbon steel parallel pin punches heat treated to HRC52 +/-2 with the strike end tempered to HRC40 +/-5 and containing: 3, 4, 5, 6, 7 and 8mm parallel pin punches. Supplied in a handy storage holder.



Punches

Parallel pin punches, hardened for long life.

Stock No.	Size mm	Type	Length mm
PP03	Parallel pin punch	3	150
PP04	Parallel pin punch	4	150
PP05	Parallel pin punch	5	150
PP06	Parallel pin punch	6	150
PP07	Parallel pin punch	7	150
PP08	Parallel pin punch	8	150

Punches →



Centre Punches

Special steel centre punches, hardened for longer life.

Stock No.	Size mm	Length mm
CP04	4	150
CP05	5	150
CP08	8	150



SCP01 Automatic Centre Punch

Automatic centre punch with spring loaded stroke. The spring is compressed and released when the tip is pushed down to create an indentation in the material to be marked. 1mm tip diameter, overall length 135mm and complete with pocket clip.



Scriber Round, knurled handle with pocket clip.

Length	mm	135
Diameter	mm	7



RIVETING TOOLS

A broad range of riveting tools for manual installation of pop-rivets and blind rivets, including standard hand modes, lattice models and models with long handles. The jaws can be removed quickly for cleaning or when switching between different rivet sizes.

Pop-riveters

- On pop-riveters for heavy-duty applications the upper and lower handles are made of a combination of aluminium and forged steel for maximum performance.
- Special support pins to reduce uneven loads and possible wear on the aluminium section are fitted on the heavy-duty models.

Lattice riveters

- Tool body of high strength aluminium.
- Lattice section of high strength steel with four-part lever arms to reduce hand force and maximise efficiency.
- Jaws and jaw housing of high grade alloyed steel, precision made for unbeatable durability.
- Bolts of alloy forged steel for high strength.
- System with 3 jaws for extra power and simple loading and removal of the rivet.

Pop-riveter with long handles

- Tool body of high strength aluminium.
- A spring for high torsional strength balances the movement so that pressing one handle controls the riveter while the other hand can be used as a counterhold. The rivet can also be safely left in the nozzle when using in a downward position.
- Used mandrels are collected in a container to protect the user and to keep the working area clean.
- Jaws and jaw housing of high grade alloyed steel, precision made for unbeatable durability.
- Bolts of alloy forged steel for high strength.
- System with 3 jaws for extra power and simple loading and removal of the rivet.
- Long stroke length maximises efficiency and makes the work faster.

Blind nut riveter

- Blind nut riveter made of aluminium alloy with the top handle of forged steel. The threaded inserts (M3 to M6) are of high grade steel alloy are lockable and can be changed quickly. Can be ordered individually or in TT trays.
- Heavy duty blind nut riveter with long handles. M5 to M10 threaded inserts included. Pull rods with compound action makes it quick to load and empty.

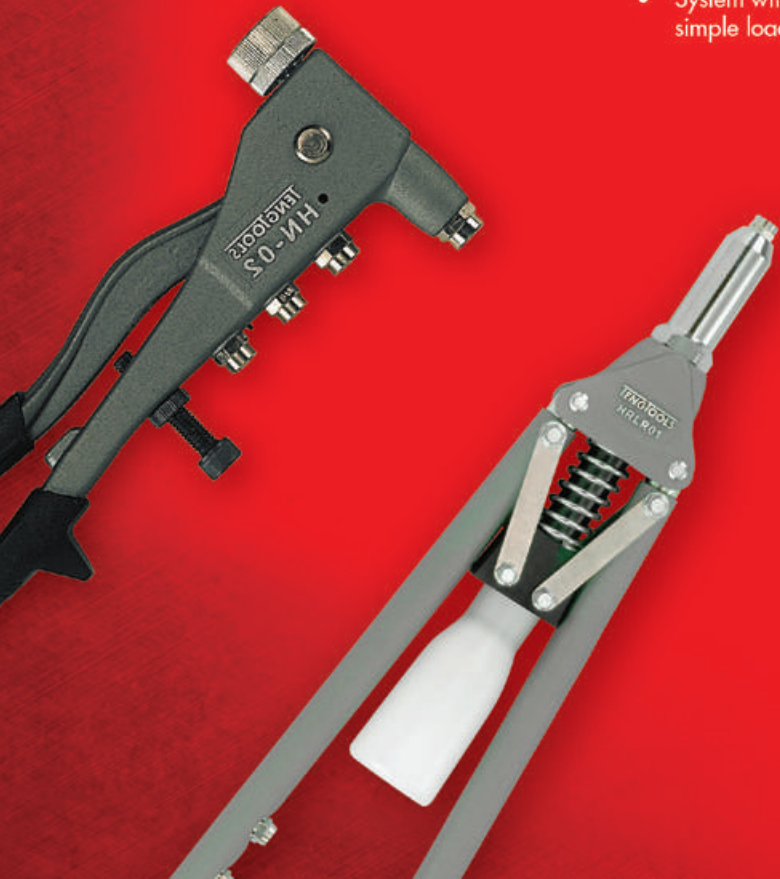

HR12 Rivet Gun

Hand rivet gun for professional use in the construction and industrial work place. Supplied with four interchangeable nose bushes (for rivets 2.4, 3.2, 4.0 and 4.8mm) and plastic handles for improved grip. Spare parts set available (stock no. HR12RK).

Aluminium mm	Steel mm	Stainless steel mm	Length mm	Weight g
2.4/3.2/4.0/4.8	2.4/3.2/4.0/4.8	2.4/3.2/4.0	250	560



HR14 Rivet Gun

Heavy duty steel plate. The jaw and case are heat treated steel alloy. PVC grip. Repair kit available (stock no. HR14RK).

Aluminium mm	Rivet capacity steel mm	Length mm	Weight g
2.4, 3.0/3.2,	2.4/3.0/3.2	270	627



HR30R Rivet Gun

For professional use in construction and industrial applications with 4 nose bushes (for rivets 2.4, 3.2, 4.0, 4.8mm) and plastic covered handles. Repair kit available (stock no. HR30-RRK2).

Aluminium mm	Steel mm	Stainless steel mm	Length mm	Weight g
2.4/3.0/3.2/4.0/4.8	2.4/3.0/3.2/4.0/4.8	2.4/3.0/3.2/4.0/4.8	270	560



TTHR81 Rivet Gun Set

Set containing one rivet gun with four nozzles as well as 75 assorted rivets (2.4, 3.2, 4.0 and 4.8mm). Supplied in the unique Teng Tools TC tray with removable lid and dove tail joints for use on it's own or as part of the Teng Tools TC control system. (265x142x50mm, 1.0 kilos)

Hand rivetter	with four nozzles to suit aluminium/steel blind rivets (2.4, 3.2, 4.0, 4.8mm)
Aluminium rivets	2.4mm (3/32") x 20 black
Aluminium rivets	3.2mm (1/8") x 20 black
Aluminium rivets	4.0mm (5/32") x 20 black
Aluminium rivets	4.8mm (3/16") x 15 black
Accessories	nozzle wrench



HR01 Rivet Gun

Aluminium alloy, forged steel upper handle. The jaw and case are high grade heat treated steel alloy. PVC grip. Repair kit available (HR01RK).

Aluminium mm	Steel mm	Stainless steel mm	Length mm	Weight g
2.4/3.2/4.0/4.8	2.4/3.2/4.0/4.8	2.4/3.2/4.0	250	560



HR360R Swivel Head Rivet Gun

For professional use in construction and industrial applications. The nose is adjustable between two positions for riveting vertically or horizontally. Supplied with four nose bushes.

Aluminium mm	Steel mm	Stainless steel mm	Length mm	Weight g
2.4/3.0/3.2/4.0/4.8/5.0	2.4/3.0/3.2/4.0	2.4/3.0/3.2	295	712



HRLT01 Lazy Tongue Rivet Gun

For professional use in construction and industrial applications. There are 3 jaws available giving a better grip and release of the nail. The lazy tong design gives a large rivetting force and is suitable for use in areas difficult to access. The long nose is good for access, with 5 nose bushes for rivet diameters of 3.2, 4.0, 4.8, 6.0 and 6.4mm. (Repair kits are available on request). Spare parts set available (stock no. HRLT01RK).



HRLR01 Long Handle Rivet Gun

For professional use in construction and industrial applications. The two hand grips gives a large rivetting capacity. There are 3 jaws available giving a better grip and release of the nail. A plastic container collects all the mandrels, with 5 nose bushes for rivet diameter of 3.2, 4.0, 4.8, 6.0 and 6.4mm. (Repair kits available) Spare parts set available (stock no. HRLR01RK, Price £41.90), set of five replacement nozzles also available (stock no HRLR01RK-2).



TTNR81 Nutsert tool set

Set containing a nutsert gun together with 75 assorted blind nutserts. Supplied in the unique Teng Tools TC tray with removable lid and dove tail joints for use on it's own or as part of the Teng Tools TC control system. (265x142x50mm, 1.0 kilos)

Nut sert tool	with four quick change mandrels (M3 x 0.5, M4 x 0.7, M5 x 0.8, M6 x 1.0)
Accessories	nose piece wrench
Nut serts	M3 x 20 pieces, M4 x 20 pieces, M5 x 20 pieces, M6 x 15 pieces



HN02 Nutsert Tool

Aluminium alloy, forged steel upper handle, quick change, lockable, threaded mandrel, high grade steel alloy. PVC grip. Spare parts set available (stock no. HN02RK).

Nutsert capacity	Length mm	Weight g
M3 x 0.5, M4 x 0.7, M5 x 0.8, M6 x 1.0	250	10

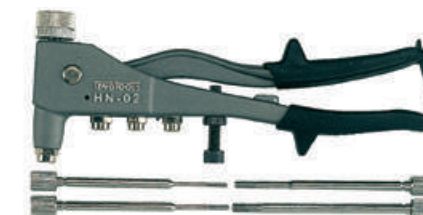

HRLN65N Nutsert Tool

For professional use in construction and industrial applications. The two hand grips gives a large rivetting capacity. It has a draw rod compound action for quick loading and unloading. Mandrels for M5, M6, M8 and M10 included. Supplied in a metal case. Four piece mandrel set available (stock no. HRLN65NRK-1).

Nutsert capacity	Length mm	Weight g
M5, M6, M8, M10	530	1800



THE RIGHT LENS?

Lens Colour	CE scale no.	Visible Light 380-780nm	General Features
Clear	2-1.2 2C-1.2	90% (UV385)	<ul style="list-style-type: none"> General purpose that provides maximum visibility. Indoor lens, good for mechanical work, or dusk, dawn and night time activities. For shooting indoors when no contrast is needed. An excellent safety lens while hand loading.
Amber	2-1.2	89% (UV385)	<ul style="list-style-type: none"> Maximum enhancement of contrast in low light environments i.e. warehouse. Blocks out 87% of blue light with unparalleled level of detail definition & colour recognition. Offers brighter view in early morning or late evening, on cloudy, foggy, or hazy days. Suitable for night shift workers, surface inspection and mechanical work. Recommended for shooting and indoor racquet sports.
Orange	2-1.7	47% (UV385)	<ul style="list-style-type: none"> Suitable for all "medium light" conditions such as partly sunny, dull cloudy days and overcast conditions. Absorb 87% blue light, reduce glare and enhances the orange of the target. Increase contrast & visual acuity and reduces eye fatigue. Good for surface inspection, medical/dentistry and mechanical work.
Smoke	5-2.5	18% (UV385)	<ul style="list-style-type: none"> Transmits all colours at the same level. Protects eyes from excessive glare and high levels of hazardous visible light and ultraviolet radiation without distorting colour perception. Ideal for outdoors, for use on bright days & bright sunlight, but does not enhance target. General purpose safety lens / the most popular tinted lens.
Green	3-3	16% (UV385)	<ul style="list-style-type: none"> Provides protection from excessive glare and harmful ultraviolet radiation. Alternative to standard smoke lens.
IR3	Shade 3	8-18%	<ul style="list-style-type: none"> Suitable for welders assistant (indirect exposure) in the environments with low to medium levels of IR radiation e.g. metal pouring, gas soldering, cutting and brazing.
IR5	Shade 5	1.18-3.16%	<ul style="list-style-type: none"> Environments with low to medium levels of IR radiation e.g. metal pouring, gas soldering, cutting and brazing. Light acetylene welding.



THE RIGHT FRAME AND THE RIGHT LENS SPECIFICATION?

Teng Tools glasses are made to exacting standards and as a piece of safety equipment it is important that the user can see that he is correctly protected so each Teng Tools item is individually marked on the frame and the lens with codes that give information about what specifications that item is manufactured to.

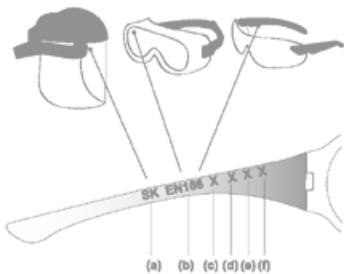

MARKING OF FRAMES

- Manufacturer**
- EN standard number**
- Suitable areas of application**
No marking = basic use (glasses)
3 = liquids (goggles and visors)
4 = dust particles >µm (goggles)
5 = gas and dust particles >µm (goggles)
8 = short circuit electrical arcs (visors)
9 = molten metal and hot material (goggles and visors)
- Mechanical resistance**
S = enhanced strength
F = high speed, low energy impact (6mm steel ball at 45 m/s)
B = high speed, medium energy impact (6mm steel ball at 120 m/s)
A = high speed, high energy impact (6mm steel ball at 190 m/s)
Marking "T" after the symbol for mechanical resistance indicates protection at extreme temperatures (FT, BT, AT)
- H = suitable for a smaller head shape**
- Highest shade number compatible with that particular frame**

MARKING OF LENSES

- Filter type**
2 or 2C = UV
4 = IR
5 or 6 = sun filter
- Shade number** (without filter type number = welding filter)
- Manufacturer**
- Optical class**
1 = permanent use
2 = temporary use
3 = used in exceptional cases
- Mechanical resistance**
S = enhanced strength
F = high speed, low energy impact (6mm steel ball at 45 m/s)
B = high speed, medium energy impact (6mm steel ball at 120 m/s)
A = high speed, high energy impact (6mm steel ball at 190 m/s)
Marking "T" after the symbol for mechanical resistance indicates protection at extreme temperatures (FT, BT, AT)
- Other requirements**
8 = short circuit electric arcs (visors)
9 = molten metal and hot materials (goggles and visors)
K = resistance to surface damage by fine particles
R = enhanced reflection factor.

SAFETY GLASSES

Optically neutral lens with anti-fog and anti scratch resistance (HC/AF) or just scratch resistance (HC). Polycarbonate lenses with large panorama view and integrated side protection. Suitable for work wear or for visitor protection wear. The glasses are in accordance with EN166 class 1FT. Yellow lens also meets EN170 and the grey lens meets EN172.

Stock No.	Lens	Scratch resistant	Anti fog
SG960	Clear	Y	Y
SG960G	Grey/Smoke	Y	Y
SG960Y	Yellow	Y	Y
SG960A	Clear	Y	-

Safety Glasses →



SAFETY GLASSES

A more sports inspired design with optically neutral lens with anti-fog and anti scratch resistance (HC/AF) and a soft bridge nose and side pieces for extra comfort. Polycarbonate lenses with large panorama view and integrated side protection. Suitable for work wear or for visitor protection wear. The glasses are in accordance with EN166 class 1FT. Grey lens also meets EN172.

Stock No.	Lens	Scratch resistance	Anti Fog
SG713	Clear	Y	Y
SG713G	Grey/Smoke	Y	Y

Safety Glasses →



TYPICALLY TENG AIR TOOLS

The brand new range of Teng Tools air tools has been created by our Product Development team to combine our expertise in mechanics hand tools with the very latest materials together with leading production and engineering methods. The result is a range of all the most frequently used air tools with products that easily meet or exceed the demands of the market and the specifications of professional workshop and industrial users.

The range has been developed with the user in mind with features such as ergonomic design and toughness. Advantages such as rubber grips, composite materials, swivelling air inlets and reduced vibration are all “Typically Teng” features that combine to make Teng Tools air tools the preferred choice for professional users.

IMPACT WRENCH

- Lightweight but strong aluminium housing
- Twin hammer mechanism for increased torque and reduced vibration
- Forward / reverse button for one handed operation
- Ergonomically designed handle for better grip and insulation against vibration and cold air
- High torque action with three forward steps plus reverse

COMPOSITE IMPACT WRENCH

- Sound absorbent, extra lightweight composite housing
- Twin hammer mechanism for increased torque and reduced vibration
- Forward / reverse button for one handed operation
- Ergonomically designed handle for better grip and insulation against vibration and cold air
- High torque action with three forward steps plus reverse

COMPACT IMPACT WRENCH

- Compact and light weight for easier use in confined spaces
- Extra high torque capacity compared to size and weight
- “Jumbo” clutch mechanism
- High torque action with three forward steps plus reverse
- Also available as a set in the Teng Tools double width tool tray for use on it’s own or as part of the Teng Tools tool control system

BLOW GUN

- Ergonomically designed pistol grip for left or right hand use
- Low effort trigger operation for easier use
- Metal thread insert
- Hanging hole for when not in use

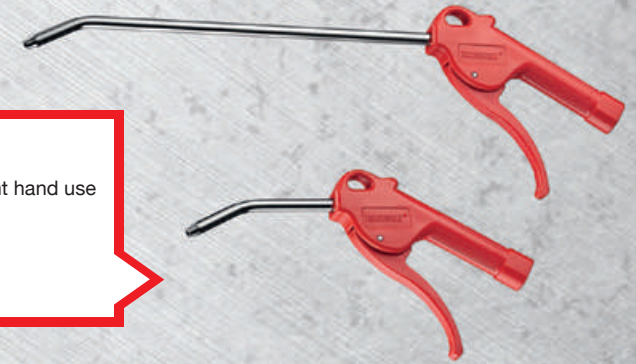

AIR DRILL

- Pistol style air drills for easier operation
- Suitable for both left and right hand use
- Thumb switch lever to change direction quickly and easily
- Quick chuck mechanism for simple changing of drill bits
- Ergonomically designed handle for better grip and insulation against vibration and cold air



AIR RATCHET

- Ergonomically designed pistol grip for left or right hand use
- Forward and reverse action
- Metal trigger “squeeze” action for easier use
- Simple single clutch operation
- Ideal for working in confined areas



AIR SAW

- Ergonomically designed handle for better grip and insulation against vibration and cold air
- Metal trigger and safety cut off throttle mechanism for safer use
- Swivelling air intake for easier use and less interference from air line
- Suitable for sawing different materials such as metals, plastics, wood etc.
- Adjustable saw blade support for use with different length blades



STRAIGHT IMPACT WRENCH

- High torque output with minimum weight
- Twin hammer mechanism for increased torque and reduced vibration
- Sound absorbent, extra lightweight composite housing
- High torque action with four forward steps plus reverse
- Support handle for easier operation



ARWM38 3/8" Drive Impact Wrench

A robust and powerful, reversible impact wrench especially for workshop applications. High torque action with three forward steps and reverse. Housing manufactured in lightweight but hard wearing aluminium. Twin hammer mechanism for increased torque, greater reliability and reduced vibration. Forward/reverse button for one handed operation. Ergonomically designed handle for better grip and insulation against vibration and cold air.

Square drive		3/8"
Bolt capacity	mm	M13
Free speed	rpm	9,000
Max torque (3 steps)	Nm	115/285/465
Max torque (3 steps)	ft-lb	85/210/342
Max reverse torque	Nm	490
Max reverse torque	ft-lb	361
Hammer mechanism	type	Twin hammer
Sound level *	dB	95.4
Vibration **	m/s ²	4.96
Minimum hose size	inch	3/8"
Air inlet	inch	1/4"
Air consumption at 100% int.	l/min	105
Air consumption at 100% int.	cfm	3.7
Air consumption at 15% int.	l/min	16
Air consumption at 15% int.	cfm	0.6
Length	mm	159.4
Weight	kg	1.5



* A weighted sound pressure level at work station in accordance with EN ISO 15744

** Vibration value according to EN ISO 28927-2

ARWM34 3/4" Drive Impact Wrench

A robust and powerful, reversible impact wrench especially for workshop applications. High torque action with three forward steps and reverse. Housing manufactured in lightweight but hard wearing aluminium. Twin hammer mechanism for increased torque, greater reliability and reduced vibration. Forward/reverse button for one handed operation. Ergonomically designed handle for better grip and insulation against vibration and cold air.

Square drive		3/4"
Bolt capacity	mm	M32
Free speed	rpm	5,000
Max torque (3 steps)	Nm	1,084/1,300/1,790
Max torque (3 steps)	ft-lb	800/960/1,320
Max reverse torque	Nm	1,830
Max reverse torque	ft-lb	1,349
Hammer mechanism	type	Twin hammer
Sound level *	dB	95.1
Vibration **	m/s ²	11.88
Minimum hose size	inch	1/2"
Air inlet	inch	3/8"
Air consumption at 100% int.	l/min	181
Air consumption at 100% int.	cfm	6.4
Air consumption at 15% int.	l/min	27.2
Air consumption at 15% int.	cfm	1.0
Length	mm	218.8
Weight	kg	3.9



* A weighted sound pressure level at work station in accordance with EN ISO 15744

** Vibration value according to EN ISO 28927-2

ARWM12 1/2" Drive Impact Wrench

A robust and powerful, reversible impact wrench especially for workshop applications. High torque action with three forward steps and reverse. Housing manufactured in lightweight but hard wearing aluminium. Twin hammer mechanism for increased torque, greater reliability and reduced vibration. Forward/reverse button for one handed operation. Ergonomically designed handle for better grip and insulation against vibration and cold air.

Square drive		1/2"
Bolt capacity	mm	M16
Free speed	rpm	6,800
Max torque (3 steps)	Nm	385/530/930
Max torque (3 steps)	ft-lb	285/390/685
Max reverse torque	Nm	950
Max reverse torque	ft-lb	700
Hammer mechanism	type	Twin hammer
Sound level *	dB	92.5
Vibration **	m/s ²	22.45
Minimum hose size	inch	3/8"
Air inlet	inch	1/4"
Air consumption at 100% int.	l/min	162
Air consumption at 100% int.	cfm	5.3
Air consumption at 15% int.	l/min	24.3
Air consumption at 15% int.	cfm	0.8
Length	mm	183.1
Weight	kg	2.5



* A weighted sound pressure level at work station with muffler in accordance with EN ISO 15744

** Vibration value according to EN ISO 28927-2

ARWC38 3/8" Drive Composite Impact Wrench

A robust and powerful, reversible impact wrench especially for workshop applications. High torque action with three forward steps and reverse. Housing manufactured in sound absorbent, extra lightweight composite material. Twin hammer mechanism for increased torque, greater reliability and reduced vibration. Forward/reverse button for one handed operation. Ergonomically designed handle for better grip and insulation against vibration and cold air.

Square drive		3/8"
Bolt capacity	mm	M13
Free speed	rpm	9,000
Max torque (3 steps)	Nm	163/244/450
Max torque (3 steps)	ft-lb	120/180/331
Max reverse torque	Nm	470
Max reverse torque	ft-lb	346
Hammer mechanism	type	Twin hammer
Sound level *	dB	94.0
Vibration **	m/s ²	3.80
Minimum hose size	inch	3/8"
Air inlet	inch	1/4"
Air consumption at 100% int.	l/min	128
Air consumption at 100% int.	cfm	4.5
Air consumption at 15% int.	l/min	19
Air consumption at 15% int.	cfm	0.7
Length	mm	161
Weight	kg	1.3



* A weighted sound pressure level at work station in accordance with EN ISO 15744

** Vibration value according to EN ISO 28927-2

ARWC12 1/2" Drive Composite Impact Wrench

A robust and powerful, reversible impact wrench especially for workshop applications. High torque action with three forward steps and reverse. Housing manufactured in sound absorbent, extra lightweight composite material. Twin hammer mechanism for increased torque, greater reliability and reduced vibration. Forward/reverse button for one handed operation. Ergonomically designed handle for better grip and insulation against vibration and cold air.

Square drive	1/2"	
Bolt capacity	mm	M16
Free speed	rpm	6,800
Max torque (3 steps)	Nm	258/461/930
Max torque (3 steps)	ft-lb	190/340/685
Max reverse torque	Nm	960
Max reverse torque	ft-lb	708
Hammer mechanism	type	Twin hammer
Sound level *	dB	96.0
Vibration **	m/s ²	3.60
Minimum hose size	inch	3/8"
Air inlet	inch	1/4"
Air consumption at 100% int.	l/min	144
Air consumption at 100% int.	cfm	5.1
Air consumption at 15% int.	l/min	22
Air consumption at 15% int.	cfm	0.8
Length	mm	186
Weight	kg	2.0



* A weighted sound pressure level at work station in accordance with EN ISO 15744

** Vibration value according to EN ISO 28927-2

ARWC34 3/4" Drive Composite Impact Wrench

A robust and powerful, reversible impact wrench especially for workshop applications. High torque action with three forward steps and reverse. Housing manufactured in sound absorbent, extra lightweight composite material. Twin hammer mechanism for increased torque, greater reliability and reduced vibration. Forward/reverse button for one handed operation. Ergonomically designed handle for better grip and insulation against vibration and cold air.

Square drive	3/4"	
Bolt capacity	mm	M32
Free speed	rpm	6,000
Max torque (3 steps)	Nm	1,084/1,300/1,790
Max torque (3 steps)	ft-lb	800/960/1,320
Max reverse torque	Nm	1,830
Max reverse torque	ft-lb	1,349
Hammer mechanism	type	Twin hammer
Sound level *	dB	100.1
Vibration **	m/s ²	18.71
Minimum hose size	inch	1/2"
Air inlet	inch	3/8"
Air consumption at 100% int.	l/min	195
Air consumption at 100% int.	cfm	6.9
Air consumption at 15% int.	l/min	29
Air consumption at 15% int.	cfm	1.0
Length	mm	218.8
Weight	kg	3.5



* A weighted sound pressure level at work station in accordance with EN ISO 15744

** Vibration value according to EN ISO 28927-2

TTDAWM13M 1/2" Drive Compact Impact Gun Set

A 13 piece impact gun set including a compact and lightweight 1/2" drive impact wrench for use in confined spaces together with stubby 1/2" drive impact sockets covering 10 to 24mm. Supplied in the unique Teng Tools double TC tray with removable lid and dove tail joints for use on its own or as part of the Teng Tools TC control system. (265x284x50mm, 3.2 kilos).

Square drive	1/2"	
Impact sockets – stubby	mm	10, 12, 13, 14, 15, 16, 17, 18, 19, 21, 22, 24
Bolt capacity	mm	M16
Free speed	rpm	8,000
Max torque (3 steps)	Nm	285/380/680
Max torque (3 steps)	ft-lb	210/280/501
Max reverse torque	Nm	770
Max reverse torque	ft-lb	568
Hammer mechanism	type	Jumbo hammer
Minimum hose size	inch	3/8"
Air inlet	inch	1/4"
Air consumption at 100% int.	l/min	121
Air consumption at 100% int.	cfm	4.23
Air consumption at 15% int.	l/min	18
Air consumption at 15% int.	cfm	0.6
Weight	kg	3.2



ARWM12M 1/2" Drive Compact Impact Wrench

A compact and light weight reversible impact wrench especially for use in confined spaces. Extra high torque capacity for the size and weight achieved through the "Jumbo" clutch mechanism. With three forward steps and reverse. Housing manufactured in sound absorbent, extra lightweight composite material. Forward/reverse button for one handed operation. Ergonomically designed handle for better grip and insulation against vibration and cold air.

Square drive	1/2"	
Bolt capacity	mm	M16
Free speed	rpm	8,000
Max torque (3 steps)	Nm	285/380/680
Max torque (3 steps)	ft-lb	210/280/501
Max reverse torque	Nm	770
Max reverse torque	ft-lb	568
Hammer mechanism	type	Jumbo hammer
Sound level *	dB	102.0
Vibration **	m/s ²	7.50
Minimum hose size	inch	3/8"
Air inlet	inch	1/4"
Air consumption at 100% int.	l/min	121
Air consumption at 100% int.	cfm	4.23
Air consumption at 15% int.	l/min	18
Air consumption at 15% int.	cfm	0.6
Length	mm	113
Weight	kg	1.3



* A weighted sound pressure level at work station in accordance with EN ISO 15744

** Vibration value according to EN ISO 28927-2

ARWM11S 1" Drive Composite Impact Wrench

A robust and powerful, reversible impact wrench especially for workshop applications. High torque action with four forward steps and reverse. Housing manufactured in sound absorbent, extra lightweight composite material. Twin hammer mechanism for increased torque, greater reliability and reduced vibration. Forward/reverse button for one handed operation. Ergonomically designed handle for better grip and insulation against vibration and cold air. Support handle for easier operation.

Square drive		1"
Bolt capacity	mm	M36
Free speed	rpm	5,500
Max torque (4 steps)	Nm	976/1,300/1,735/2,712
Max torque (4 steps)	ft-lb	720/960/1,280/2,000
Max reverse torque	Nm	2,730
Max reverse torque	ft-lb	2,013
Hammer mechanism	type	Twin hammer
Sound level *	dB	104.5
Vibration **	m/s ²	12.88
Minimum hose size	inch	3/4"
Air inlet	inch	1/2"
Air consumption at 100% int.	l/min	271
Air consumption at 100% int.	cfm	9.6
Air consumption at 15% int.	l/min	41
Air consumption at 15% int.	cfm	1.4
Length	mm	504.5
Weight	kg	8.1



* A weighted sound pressure level at work station in accordance with EN ISO 15744
 ** Vibration value according to EN ISO 28927-2

ARRM38 3/8" Drive Air Ratchet

A robust and powerful, reversible air ratchet especially designed working in confined areas in various workshop applications. High torque forward and reverse action with a simple single clutch operation and a metal "squeeze action" trigger for easier use. Ergonomically designed handle for better grip and insulation against vibration and cold air.

Square drive		3/8"
Bolt capacity	mm	M10
Free speed	rpm	220
Forward/reverse torque	Nm	41
Forward/reverse torque	ft-lb	30
Sound level *	dB	88.1
Vibration **	m/s ²	9.71
Minimum hose size	inch	3/8"
Air inlet	inch	1/4"
Air consumption at 100% int.	l/min	90.6
Air consumption at 100% int.	cfm	3.2
Air consumption at 15% int.	l/min	14
Air consumption at 15% int.	cfm	0.5
Length	mm	173.9
Weight	kg	0.6



* A weighted sound pressure level at work station in accordance with EN ISO 15744
 ** Vibration value according to EN ISO 28927-2

ARR12 1/2" Drive Air Ratchet

A robust and powerful, reversible air ratchet especially designed working in confined areas in various workshop applications. High torque forward and reverse action with a simple single clutch operation and a metal "squeeze action" trigger for easier use. Ergonomically designed handle for better grip and insulation against vibration and cold air.

Square drive		1/2"
Bolt capacity	mm	M13
Free speed	rpm	160
Forward/reverse torque	Nm	95
Forward/reverse torque	ft-lb	70
Sound level *	dB	91.6
Vibration **	m/s ²	6.00
Minimum hose size	inch	3/8"
Air inlet	inch	1/4"
Air consumption at 100% int.	l/min	113.2
Air consumption at 100% int.	cfm	4
Air consumption at 15% int.	l/min	17
Air consumption at 15% int.	cfm	0.6
Length	mm	277
Weight	kg	1.3



* A weighted sound pressure level at work station in accordance with EN ISO 15744
 ** Vibration value according to EN ISO 28927-2

ARD10 10mm Air Drill

A pistol style air drill for easy operation that is suitable for both left and right handed use. Simple to use with a thumb switch lever for changing direction quickly and easily together with a quick change chuck mechanism for easier changing of drill bits. Ergonomically designed handle for better grip and insulation against vibration and cold air.

Chuck size	mm	10
Free speed	rpm	1,800
Minimum hose size	inch	3/8"
Air inlet	inch	1/4"
Sound level *	dB	87.6
Vibration **	m/s ²	2.73
Air consumption at 100% int.	l/min	121.4
Air consumption at 100% int.	cfm	4.3
Air consumption at 15% int.	l/min	18
Air consumption at 15% int.	cfm	0.7
Length	mm	206.2
Weight	kg	1.2



* A weighted sound pressure level at work station in accordance with EN ISO 15744
 ** Vibration value according to EN ISO 28927-2

ARD13 13mm Air Drill

A pistol style air drill for easy operation that is suitable for both left and right handed use. Simple to use with a thumb switch lever for changing direction quickly and easily together with a quick change chuck mechanism for easier changing of drill bits. Ergonomically designed handle for better grip and insulation against vibration and cold air.

Chuck size	mm	13
Free speed	rpm	450
Minimum hose size	inch	3/8"
Air inlet	inch	1/4"
Sound level *	dB	88.8
Vibration **	m/s ²	1.93
Air consumption at 100% int.	l/min	140
Air consumption at 100% int.	cfm	5
Air consumption at 15% int.	l/min	21
Air consumption at 15% int.	cfm	0.8
Length	mm	249.5
Weight	kg	1.9



* A weighted sound pressure level at work station in accordance with EN ISO 15744
 ** Vibration value according to EN ISO 28927-2

ARS01 Air Saw

A robust and powerful air saw suitable for cutting a variety of materials such as metals, plastic, wood, etc. with an adjustable blade support for use with different length blades. A metal trigger and safety cut off throttle mechanism make for safer use while the ergonomically designed handle gives better grip and insulation against vibration and cold air. A swivelling air intake ensures less interference from the airline making the air saw easier and safer to use.

Stroke length	mm	10
Strokes per minute	bpm	9,000
Cutting capacity – steel	mm	3.0
Cutting capacity – aluminium	mm	3.4
Cutting capacity – wood	mm	4.0
Sound level *	dB	83.6
Vibration **	m/s ²	<2.4
Minimum hose size	inch	3/8"
Air inlet	inch	1/4"
Air consumption at 100% int.	l/min	31
Air consumption at 100% int.	cfm	1.08
Air consumption at 15% int.	l/min	4.7
Air consumption at 15% int.	cfm	0.2
Length	mm	245.1
Weight	kg	0.7



* A weighted sound pressure level at work station in accordance with EN ISO 15744
 ** Vibration value according to EN ISO 28927-2

Air Tools

ARG01 Air Die Grinder **NEW!**

A robust and powerful air die grinder with a composite grip for added comfort, a rear exhaust with a silencer and a safety throttle lever.

Angle		straight
Collet	mm	6
Free speed	rpm	25,000
Sound level*	dB(A)	81.78
Vibration **	m/s ²	5.42
Minimum hose size	inch	3/8
Air inlet	inch	1/4
Air consumption at 100% int.	l/min	113
Air consumption at 15% int.	l/min	16.9
Air consumption at 100% int.	cfm	4.0
Air consumption at 15% int.	cfm	0.6
Length	mm	161
Weight	g	400



* A weighted sound pressure level at work station in accordance with EN ISO 15744
 ** Vibration value according to EN ISO 28927-2

ARG02 Air Die Grinder **NEW!**

A robust and powerful air die grinder for use at 90 degrees. Includes a composite grip for added comfort, a rear exhaust with a silencer and a safety throttle lever.

Angle		90°
Collet	mm	6
Free speed	rpm	25,000
Sound level*	dB(A)	81.78
Vibration **	m/s ²	5.42
Minimum hose size	inch	3/8
Air inlet	inch	1/4
Air consumption at 100% int.	l/min	113
Air consumption at 15% int.	l/min	16.9
Air consumption at 100% int.	cfm	4.0
Air consumption at 15% int.	cfm	0.6
Length	mm	165
Weight	g	400



* A weighted sound pressure level at work station in accordance with EN ISO 15744
 ** Vibration value according to EN ISO 28927-2

Air Tools

Air Blow Guns

Ergonomically designed pistol grip air blow guns. Suitable for left or right handed use. A low effort trigger mechanism gives easier use, a metal thread insert for reliability and a hanging hole for when not in use.

Stock No		ARB01	ARB02
Nozzle length	mm	100	270
Air inlet	inch	1/4"	1/4"
Length	mm	212	360
Weight	g	106	130



OSHA Air Blow Gun **NEW!**

Ergonomically designed pistol style grip air blow gun with a relief slot that conforms to OSHA (Occupational Safety and Health Administration) safety standards. Suitable for left or right handed use. A low effort trigger mechanism gives easier use, a metal thread insert for reliability and a hanging hole for when not in use.

Stock No		ARB03
Nozzle length	mm	100
Air inlet	inch	1/4
Length	mm	212
Weight	g	160



* A weighted sound pressure level at work station in accordance with EN ISO 15744 ** Vibration value according to EN ISO 28927-2

Measuring Tools

TTCM05D Measuring Set

5 piece general measuring set containing 150mm digital vernier caliper, micrometer 0-25 mm, square 150x100mm, steel rule 150mm and a 135 mm scribe with tungsten carbide tip. Supplied in the unique Teng Tools TC tray with removable lid and dove tail joints for use on it's own or as part of the Teng Tools TC control system. (265x142x50mm, 0.9 kilos)

Digital caliper	mm/inch	150/6"
Micrometer	mm	0/25
Precision square	mm	150 x 100
Steel rule	mm/inch	150/6"
Scriber TC tipped		135



A 150mm 4 function digital caliper with 40mm jaw length. Adjustable between mm and inches, reset button, 0.01mm reading scale with 6mm high figures, automatic switch off and screw lock. Zero set in any position. DIN862. Uses 2 x LR44 type batteries.

Stock no.		CAL150D
Length of measurement	mm	150
Jaw length	mm	40
Height of figures	mm	10
Resolution	mm	0.01



Forged frame and matt chrome plated scale. Hardened 6.5mm spindle with polished measuring surfaces of hard metal. Friction sleeve and locking nut. DIN863.

Stock no.		MIR050
Measuring range	mm	0-25
Reading	mm	0.01
Precision	+/- mm	0.004



Measuring Tapes

Measuring tapes with ABS case, tape lock and belt clip. Power return tape features metric and imperial graduations as well as aligning hook for internal/external measurement. Class II.

Stock No.	Measuring Length m	Measuring Length ft	Width mm
MT03	3	10	13
MT05	5	16	19
MT08	8	26	25



Measuring Tapes →

Measuring Tapes

Metric only measuring tapes with ABS case, tape lock and belt clip. Power return tape features metric graduations as well as aligning hook for internal/external measurement. Class II.

Stock No.	Measuring Length m	Width mm
MT03MM	3	13
MT05MM	5	19
MT08MM	8	25



Measuring Tapes →

Measuring Tapes

Metric only measuring tapes with high impact plastic cases and a rubberised grip plus a belt clip. A steel roller cage prevents damage to the case when the nylon tape is retracted. Class II.

Stock No.	Measuring Length m	Width mm
MT10	10	10
MT15	15	10
MT30	30	10

Measuring Tapes →



Measuring Tapes

Metric only measuring tapes with high impact plastic cases and a rubberised grip plus a belt clip. A steel roller cage prevents damage to the case when the nylon tape is retracted. Class II.

Stock No.	Measuring Length m	Width mm
MTS30	30	12.7
MTS50	50	12.7

Measuring Tapes →



Steel Rules

Steel rule with millimetre scale on the top edge, inches on the lower edge (150mm only with millimetre scale). With hanging hole.

Stock No.	Length mm	Width x Thickness mm
ST150	150	20 x 0.8
ST200	200	20 x 0.8

Steel Rules →



Aluminium Try Squares

Stainless steel blade with an anodised aluminium stock. The blade measures 1.5 x 45mm and the stock has an 18mm wide milled working surface. Deep etched and highly resistant to wear. Measurement accuracy of 0.03°.

Stock No.	Blade Length mm	Accuracy	Weight g
SQAA200	200	±0.03°	240
SQAA250	250	±0.03°	275
SQAA300	300	±0.03°	300



Plastic Try Squares

Stainless steel blade with a fibre glass framed plastic stock. The blade measures 1.0 x 45mm and the stock has an 18mm wide milled working surface. Deep etched and highly resistant to wear. Measurement accuracy of 0.06°.

Stock No.	Blade Length mm	Accuracy	Weight g
SQAP250	250	±0.06°	150
SQAP300	300	±0.06°	160



AB200 Sliding Bevel

200mm sliding bevel with straight and true stainless blade. Dimensions 200 x 23 x 25mm, weight 100g.

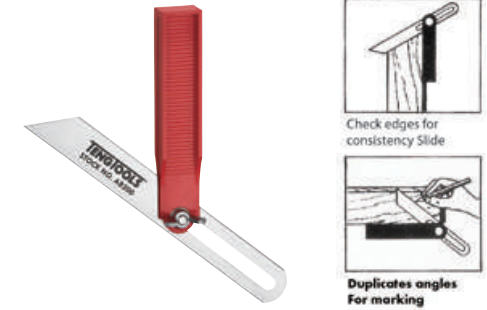

Flat Square

Made of steel with uniformly thick legs (25 x 6mm), 150mm long and 100mm short. All faces ground and polished. DIN875/2.



SLA040 Aluminium Spirit Level

Aluminium 400mm spirit level with one horizontal and two vertical vials. The design of the vials permits all round reading. Measurement accuracy of 1.0mm/m. End caps made of impact resistant plastic.

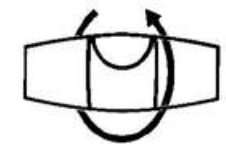

Aluminium Spirit Levels

Easy to hold 24 x 50mm profile professional quality aluminium spirit levels. Crush proof, durable tubular vials with high transparency for easy reading. Highly resistant to ultraviolet light and fluctuations in temperature the bubble is also not affected by static electricity. Shock absorbent end protectors and temperature proof vial mountings. Measurement accuracy of 0.75mm/m upside down and 0.5mm/m in normal position.



0.5mm/m Standard Position
0.75mm/m Inverted position



Stock No.	Length mm	Width mm	Height mm	Tolerance normal	Tolerance inverted	Weight g
SLA0300	300	24	50	±0.5mm/m	±0.75mm/m	210
SLA0400	400	24	50	±0.5mm/m	±0.75mm/m	280
SLA0600	600	24	50	±0.5mm/m	±0.75mm/m	420
SLA1000	1,000	24	50	±0.5mm/m	±0.75mm/m	690
SLA1200	1,200	24	50	±0.5mm/m	±0.75mm/m	840
SLA1500	1,500	24	50	±0.5mm/m	±0.75mm/m	1,050
SLA1800	1,800	24	50	±0.5mm/m	±0.75mm/m	1,260
SLA2000	2,000	24	50	±0.5mm/m	±0.75mm/m	1,400

Aluminium Spirit Levels

Heavy duty 26x589mm profile professional quality extruded aluminium spirit levels. Crush proof, durable tubular vials with high transparency for easy reading. Highly resistant to ultraviolet light and fluctuations in temperature the bubble is also not affected by static electricity. Shock absorbent end protectors and temperature proof vial mountings. Measurement accuracy of 0.75mm/m upside down and 0.5mm/m in normal position.

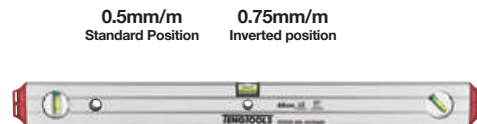

0.5mm/m Standard Position
0.75mm/m Inverted position

Stock No.	Length mm	Width mm	Height mm	Tolerance normal	Tolerance inverted	Weight g
SLC0400	400	26	58	±0.5mm/m	±0.75mm/m	348
SLC0600	600	26	58	±0.5mm/m	±0.75mm/m	522
SLC0800	800	26	58	±0.5mm/m	±0.75mm/m	696
SLC1000	1,000	26	58	±0.5mm/m	±0.75mm/m	870
SLC1200	1,200	26	58	±0.5mm/m	±0.75mm/m	1,044
SLC1500	1,500	26	58	±0.5mm/m	±0.75mm/m	1,305
SLC1800	1,800	26	58	±0.5mm/m	±0.75mm/m	1,566
SLC2000	2,000	26	58	±0.5mm/m	±0.75mm/m	1,740

Magnetic Aluminium Spirit Levels

Easy to hold 24 x 50mm profile professional quality aluminium spirit levels with magnets on the underside for fixing to ferrous work pieces (steel, etc). Crush proof, durable tubular vials with high transparency for easy reading. Highly resistant to ultraviolet light and fluctuations in temperature the bubble is also not affected by static electricity. Shock absorbent end protectors and temperature proof vial mountings. Measurement accuracy of 0.75mm/m.

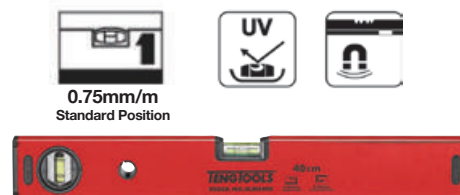

0.75mm/m Standard Position

Stock No.	Length mm	Width mm	Height mm	Tolerance normal	Tolerance inverted	Weight g
SLM0300	300	24	50	±0.75mm/m	±0.75mm/m	240
SLM0400	400	24	50	±0.75mm/m	±0.75mm/m	310
SLM0600	600	24	50	±0.75mm/m	±0.75mm/m	450
SLM1000	1,000	24	50	±0.75mm/m	±0.75mm/m	750
SLM1200	1,200	24	50	±0.75mm/m	±0.75mm/m	900

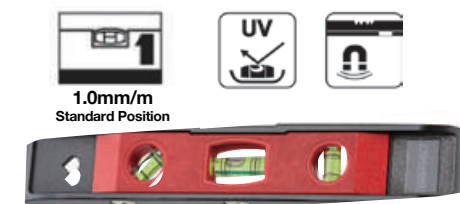

1.0mm/m Standard Position

SLT01 Aluminium Torpedo Level with metal magnets

An impact resistant black aluminium 230mm torpedo style spirit level with three metal magnets on the underside for fixing to ferrous work pieces (steel, etc). Crush proof, durable tubular vials with high transparency for easy reading including 45° angle bubble. Highly resistant to ultraviolet light and fluctuations in temperature the bubble is also not affected by static electricity. Measurement accuracy of 1.0mm/m.

Stock No.	Length mm	Width mm	Height mm	Tolerance normal	Weight g
SLT01	230	16	38	±1.0mm/m	190

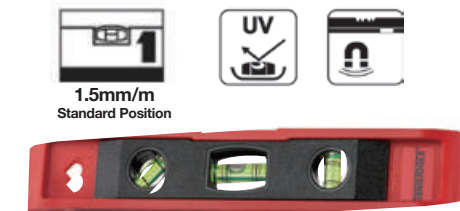

1.5mm/m Standard Position

SLT02 ABS plastic Torpedo Level with plastic magnets

An impact resistant ABS plastic 230mm torpedo style spirit level with a plastic strip magnet on the underside for fixing to ferrous work pieces (steel, etc). Crush proof, durable tubular vials with high transparency for easy reading including 45° angle bubble. Highly resistant to ultraviolet light and fluctuations in temperature the bubble is also not affected by static electricity. Measurement accuracy of 1.5mm/m.

Stock No.	Length mm	Width mm	Height mm	Tolerance normal	Weight g
SLT02	230	16	40	±1.5mm/m	160

P-CAP6 Teng Tools Baseball Cap Red

A stylish red baseball cap with adjustable strap with a buckle. Features the Teng Tools eyes logo on the peak.



P-CAP8 Teng Tools Baseball Cap Red

A special edition red Teng Tools baseball cap. Good quality with a strap and metal buckle adjustment at the back. Embroidered with the Teng Tools logo.



P-CAP7 Teng Tools Baseball Cap Black

Black baseball cap with strap and buckle for adjusting the size. Embroidered with Teng Tools logo.



P-UMB16 Teng Tools Umbrella

A smart golf style umbrella featuring the Teng Tools eyes logo.



P-PS Teng Tools Seat Belt Protector Red

A double padded protector to make car seat belts more comfortable – suitable for driver and passenger sides.



Protective Glasses

Light, comfortable work wear glasses that give stylish protection. Impact resistant with high optical clarity and conform to EN166, AS/NZS1067. Weight just 32g.

Stock no.	Style	Arm type
SG001	red frames	straight
SG002	black/grey frames	straight
SG003	black frames	curved



SG001



SG002



SG003



P-SG01



P-SG02



P-SG03



Protective Glasses

Light, comfortable work wear glasses that give stylish protection. Impact resistant with high optical clarity and conform to EN166, AS/NZS1067. Weight just 32g.

Stock no.	Style	Arm type
P-SG01	red frames	straight
P-SG02	black/grey frames	straight
P-SG03	black frames	curved

P-HN11 Teng Tools Necker Red

Can be worn as a snood style scarf, a head band, a neck warmer or even as a cap. 100% polyester.

P-BET01 Teng Tools Belt

A fully adjustable two colour textile belt with the Teng Tools logo incorporated in the metal buckle. Supplied as 1350mm but can be cut to size.

Teng Tools V neck T Shirts White

Stylish and comfortable 100% cotton V neck T shirts. A ¾" rib knit neck line, taped neck and shoulders, tubular knit and a mitred V neck pattern all combine to create a good quality T shirt that looks good and feels good to wear. Embroidered with the Teng Tools logo on the sleeve.

Stock No.	Size
POS-TSWHS	S
POS-TSWHM	M
POS-TSWHL	L
POS-TSWHXL	XL
POS-TSWHXXL	XXL



Teng Tools V neck T Shirts Black

Stylish and comfortable 100% cotton V neck T shirts. A ¾" rib knit neck line, taped neck and shoulders, tubular knit and a mitred V neck pattern all combine to create a good quality T shirt that looks good and feels good to wear. Embroidered with the Teng Tools logo on the sleeve.

Stock No.	Size
POS-TSBKS	S
POS-TSBKM	M
POS-TSBKL	L
POS-TSBKXL	XL
POS-TSBKXXL	XXL



Teng Tools V neck T Shirts Red

Stylish and comfortable 100% cotton V neck T shirts. A ¾" rib knit neck line, taped neck and shoulders, tubular knit and a mitred V neck pattern all combine to create a good quality T shirt that looks good and feels good to wear. Embroidered with the Teng Tools logo on the sleeve.

Stock No.	Size
POS-TSRS	S
POS-TSRM	M
POS-TSRL	L
POS-TSRXL	XL
POS-TSRXXL	XXL



Teng Tools Polo Shirts Red

Stylish and comfortable 50% cotton/50% polyester polo shirts. A knitted collar with 3 buttons, taped neck, hemmed sleeve and bottom all combine to create a good quality polo shirt that looks good and feels good to wear. Embroidered with the Teng Tools logo on the left breast.

Stock No.	Size	To Fit Chest Size
POS-POLORXS	XS	36"
POS-POLORS	S	38"
POS-POLORM	M	40"
POS-POLORL	L	42"/44"
POS-POLORXL	XL	46"
POS-POLORXXL	XXL	48"
POS-POLORXXXL	XXXL	50"/52"



Teng Tools Polo Shirts Black

Stylish and comfortable 50% cotton/50% polyester polo shirts. A knitted collar with 3 buttons, taped neck, hemmed sleeve and bottom all combine to create a good quality polo shirt that looks good and feels good to wear. Embroidered with the Teng Tools logo on the left breast.

Stock No.	Size	To Fit Chest Size
POS-POLOBXS	XS	36"
POS-POLOBS	S	38"
POS-POLOBM	M	40"
POS-POLOBL	L	42"/44"
POS-POLOBXL	XL	46"
POS-POLOBXXL	XXL	48"
POS-POLOBXXXL	XXXL	50"/52"



Teng Tools Hoodies Black

Stylish and comfortable 80% cotton/20% polyester hooded sweat shirts. A kangaroo style front pouch, double fabric hood with draw string, ribbed cuffs and hem create a smart and fashionable hoodie. 280gsm material. Embroidered with the Teng Tools logo on the left breast.

Stock No.	Size	To Fit Chest Size
POS-HOODXS	XS	34"
POS-HOODS	S	36"
POS-HOODM	M	40"
POS-HOODL	L	44"
POS-HOODXL	XL	48"
POS-HOODXXL	XXL	52"
POS-HOODXXXL	XXXL	56"



Teng Tools Soft Shell Jackets Black

Stylish and comfortable 92% cotton/8% elastane soft shell jackets. A water proof membrane and high performance fabric give excellent water resistance and breathability and 320gsm material provides the warmth. Adjustable cuffs and an elasticated hem with side adjuster give the comfort, three external pockets, an inner mobile phone pocket plus two pen pockets give practicality while the Teng Tools logo is embroidered on the left breast to give a finishing touch

Stock No.	Size	To Fit Chest Size
POS-SOFTBXS	XS	36"
POS-SOFTBS	S	38"
POS-SOFTBM	M	40"
POS-SOFTBL	L	42"/44"
POS-SOFTBXL	XL	46"
POS-SOFTBXXL	XXL	48"
POS-SOFTBXXXL	XXXL	50"/52"



Teng Tools Chino Trouser Black

Stylish flat fronted chino trousers in 35% cotton/65% polyester 255gsm material. Front side pockets, rear pockets with button fastenings, zip fly, straight legs, belt loops and the Teng Tools logo embroidered above the rear pocket. Good quality, hard wearing stylish trousers.

Stock No.	To Fit Waist Size	To Fit Inside Leg
POS-CH3032	30"	32"
POS-CH3034	30"	34"
POS-CH3232	32"	32"
POS-CH3234	32"	34"
POS-CH3432	34"	32"
POS-CH3434	34"	34"
POS-CH3632	36"	32"
POS-CH3634	36"	34"
POS-CH3832	38"	32"
POS-CH3834	38"	34"
POS-CH4032	40"	32"
POS-CH4034	40"	34"



Teng Tools Work Trousers Black

Hard wearing work trousers in 35% cotton/65% polyester 245gsm material. Front side leg pockets, slant entry front pockets and two rear pockets, zip fly, belt loops and the Teng Tools logo embroidered above the rear pocket. Good quality, hard wearing work trousers.

Stock No.	To Fit Waist Size	To Fit Inside Leg
POS-WT3031	30"	31"
POS-WT3033	30"	33"
POS-WT3231	32"	31"
POS-WT3233	32"	33"
POS-WT3431	34"	31"
POS-WT3433	34"	33"
POS-WT3631	36"	31"
POS-WT3633	36"	33"
POS-WT3831	38"	31"
POS-WT3833	38"	33"
POS-WT4031	40"	31"
POS-WT4033	40"	33"
POS-WT4231	42"	31"
POS-WT4233	42"	33"



Teng Tools Overalls Black

Hard wearing 35% cotton/65% polyester 245gsm material overalls. Chest pocket with stud fastening and concealed stud front with an elasticated waistband, two deep side pockets and a ruler pocket. The Teng Tools logo is embroidered on the left breast to give a finishing touch.

Stock No.	To Suit Height	To Fit Chest Size
POS-OVERBM	up to 5'11"	38"/40"
POS-OVERBL	up to 5'11"	42"/44"
POS-OVERBXL	up to 5'11"	46"/48"
POS-OVERBXXL	up to 5'11"	50"/52"



Teng Tools Overalls Red

Hard wearing 35% cotton/65% polyester 245gsm material overalls. Chest pocket with stud fastening and concealed stud front with an elasticated waistband, two deep side pockets and a ruler pocket. The Teng Tools logo is embroidered on the left breast to give a finishing touch.

Stock No.	To Suit Height	To Fit Chest Size
POS-OVERRM	up to 5'11"	38"/40"
POS-OVERRL	up to 5'11"	42"/44"
POS-OVERRXL	up to 5'11"	46"/48"
POS-OVERRXXL	up to 5'11"	50"/52"

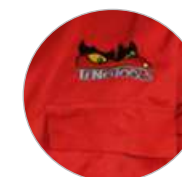

P-EZP Teng Tools Bag

A handy Teng Tools branded polyester bag with draw strings that double up as carrying straps. Ideal As a gym bag or light back pack. (370x440mm, 75g)



P-CB Teng Tools Computer Bag

A small back pack for compact lap top computers or tablets measuring up to 320x280mm. Internal pockets give handy storage for cables, mobile phone, accessories, etc. Back pack style straps and a discreet Teng Tools logo.





P-BP Teng Tools Back Pack

A versatile back pack with several compartments and pockets for storing things. Fully adjustable back straps and a carrying handle. Teng Tools branding with black trim. (360x200x490mm)



P-BP2 Teng Tools Back Pack

A smaller back pack with several compartments and pockets for storing things. Fully adjustable back straps and a carrying handle. Teng Tools branding with black trim. (310x120x470mm)



P-BM Teng Tools Travel Bag

A handy travel bag with adjustable shoulder strap and hand straps. Zip up pockets at each end for additional storage and a discreet Teng Tools logo. (430x255x290mm)



Teng Tools suit cases

Available individually in two sizes or as a matching pair. High quality suitcases with 4 castors, a telescopic handle, key lock and combination lock.

Stock No.	Length cm	Width cm	Height cm	Weight kg
P-FC16A	29	45	65	5.4
P-FC16B	25	35	49	3.8
P-FC16AB	29/25	45/35	65/49	9.2



P-LB Luggage Strap

A fully adjustable luggage strap for extra security on suit cases.



P-PW Teng Tools passport Wallet

A handy wallet for travel documents, etc with a discreet Teng Tools logo. (120x250x20mm)



P-LT Teng Tools Luggage Tag

A solid plastic credit card sized luggage tag with plastic tie on strap and space to write your name and address.



P-SW Teng Tools Stationery Wallet

A handy textile stationery wallet with holders and compartments for pens, business cards, etc.

Teng Tools Pens

A choice of colours with black or red. Blue ink biro type pens with a stylus for touch screens.

Stock No.	Colour	Ink
P-PENBK15	black	blue
P-PENR2015	red	blue



P-PENBK15



P-PENR2015

P-BH Teng Tools Bag Hook

An ingenious hook that folds in to a small round pocket sized disc but unwinds to create a gravity defying hook that can be used on the edge of a table to hang a hand bag or similar.



P-CUP15 Teng Tools Coffee Mug

A stylish, quality Teng Tools branded mug for tea or coffee.



P-WSB14 Teng Tools Water Bottle

A 70cl water bottle with sports style drinking cap. Distinctive Teng Tools branding.



P-FT17 Teng Tools Football **NEW!**

PU metallic outer surface with 32 segments and a rubber inner. Size 05.



P-COP02 Teng Tools Bottle Opener

A Teng Tools bottle opener with a bi-material grip and hanging hole.



P-CS Teng Tools Cork Screw

A Teng Tools stainless steel cork screw with knife for cutting the foil or plastic wine bottle top and a fold out lever point for easy cork removal.



P-BCHR Teng Tools Bar Stool

A 755mm tall bar stool with a seat diameter of 360mm. Cushioned seat with the Teng Tools logo. Ideal for use with the Teng Tools bar table below.



P-BT Teng Tools Bar Table

A 600mm diameter bar table with Teng Tools branding – ideal for use with the Teng Tools bar stools above.



P-TENT Teng Tools Gazebo

A Teng Tools 3 meter square gazebo style tent. A stable aluminium frame that simply folds out with extending legs and a water proof pvc coated Oxford cloth roof cover. (17 kilos)



P-TENTW Teng Tools Tent Walls

Add on side walls for the Teng Tools gazebo. Made from water proof pvc coated Oxford cloth.

P-TF01 Teng Tools Flag

A large (180x300cm) Teng Tools flag for use with 11 to 12 meter tent poles



P-TS01 Teng Tools Exterior Sign

A 600x400mm acrylic sign for fixing to indoor or outdoor walls. Fixings included to give a depth of 85mm. (1.94 kilos)



Teng Tools vinyl cut transfers

Vinyl cut transfer stickers. High quality material suitable for use on vehicles as well as general use. Black Teng Tools lettering.

Stock no.	Width mm
ST-R130	130
ST-R200	200
ST-R400	400



Teng Tools vinyl cut transfers

Vinyl cut transfer stickers. High quality material suitable for use on vehicles as well as general use. White Teng Tools lettering.

Stock no.	Width mm
ST-R130W	130
ST-R400W	400



Vinyl transfers

Vinyl stickers. High quality material suitable for use on vehicles as well as general use. Black only print.

Stock no.	Width mm
ST-R130BK	130
ST-R400BK	400



Teng Tools vinyl cut transfers

Vinyl cut transfer stickers with peel off mounting tape. High quality material suitable for use on vehicles as well as general use. Black lettering.

Stock no.	Width mm
ST-ORGANISED	65



INDEX CATEGORY	PAGE	INDEX CATEGORY	PAGE
ABS tops	75	composite air guns	421-422
adaptors - sockets	188, 206	computer bag	435
adjustable wrenches	258-259	cork screws	439
air blow guns	426	coupler adaptors	188, 326
air conditioning torque wrenches	289	covers	80-81
air drills	425	creepers	406
air guns	420-424	crimping tools	395-397
air impact wrenches	420-424	crow foot wrenches	260
air ratchets	424	crown face hammers	386
air saws	425	cupboards	77-78, 136-137
air tools	418-426	cups	438
aluminium clip rails	75	cutting tools	358-375
angular gauges	289	cylinder honing tools	381, 382
angular gauge torque wrenches	282-288	cylinder leakage testers	381
awls	377	dead blow hammers	386
back packs	436	deburring tools	364-365
bag hooks	438	die holders	369
bags	436	dies	369
ball joint separators	383	diesel injector sockets	387
ball pein hammers	406	digital calipers	427
banners	440	digital torque wrenches	284, 287
base ball caps	431	disc pad removal tools	382
basin tap wrenches	260	dividers - tool boxes	76
belts	432, 437	dollies	386
bent long nose pliers	342	door hinge wrenches	254
bicycle tool set	267, 383	double flex wrenches	253
bi flex wrenches	253	double open ended spanners	248
bit adaptors	188, 326	double ring spanners	245-247
bit drivers	316-318	drain plug keys	381
bit holders	188, 326	drawer labels	81
bit ratchets	316-318	drill bit sets	366-367
bits - flat type	319	drills	367, 425
bits - GR type	216, 321	engine cylinder honing tool	381
bits - hex type	216, 322-323	engineers hammers	406
bits - PH type	216, 320-321	engineers rules	428
bits - PZ type	216, 321-322	engineers squares	428
bits - ROB type	217, 325	EVA tool kits	40-47
bits - square type	217, 325	EVA tool tray sets	116-129
bits - T5	319	extension bars	186-187, 206, 218
bits - TPX type	325	eye protection	417, 431
bits - TX type	217, 324-325	fall protection for tools	400-401
bits - wing TX type	319	feeler gauges	377
bits boxes/sets	314-318	files	390-391
blades - knives	372-375	filter wrenches	353, 380
blades - saws	366	flags	440
blow guns	426	flare nut wrenches	253, 381
body work tools	386	flaring tools	364
bolt cutters	361	flat nose pliers	343
bottle openers	438-439	flex handles	190
bracelet	402	flex head adaptors	192
brackets (tool boxes)	76	flex head ratchets	182, 183
brake cylinder honing tool	382	flex wrenches	253
brake spring washer tool	382	flexible light	404
brick layers hammers	407	flight cases	436
cable cutters	341, 362	flush cut pliers	341
cable strippers	335, 344, 395-396	fully ground drill bits	366-367
cable tie guns	396	gasket scrapers	377, 378
calibrated torque wrenches	282-288	gazebos	439
calipers	427	glasses	417, 431
can holders	79	glue clamps	354-355
cantilever tool boxes	74, 77	grease guns	389
caps	431	groove joint pliers	343-345
carpenters pincers	345	gun saws	366
carpenters squares	428-429	hacksaw blades	365
carrying boxes	72-74	hacksaws	365-366
centre punches	411	hammers	386, 406-407
chisels	408-409	hand saws	365-366
circlip pliers	348-349	head lamps	404
circuit testers	396	heel bars	400
clamps	354-357	hex bit impact sockets	219, 223, 225
claw hammers	406-407	hex bit sets	167, 176
claw pick up tools	399	hex bit sockets	197, 200, 203
clip rail sets	159, 167, 175-177, 205	hexagon keys	266-274
clip rails	75	hobby knives	372-375
clothing - jackets	433-434	hook and picks	377, 378
clothing - overalls	435	hook wrenches	262-263
clothing - shirts and tops	432-433	hooks	83, 133
clothing - trousers	434	hose clamps	377-378
club hammers	407	hose clip drivers	376
coffee mug	438	impact driver bits	215-217
coil spring compressors	383	impact drivers	215
cold chisels	409	impact hex bit sockets	216, 219, 223, 225
combination pliers	335, 341-342	impact socket accessories	215-218
combination spanners	230-244	impact socket sets 3/8" drive	210

INDEX CATEGORY	PAGE	INDEX CATEGORY	PAGE
impact socket sets 1/2" drive	210-212	pliers - end cutters	345, 346
impact socket sets 3/4" drive	213	pliers - flat nose	343
impact sockets 1/4" drive	219	pliers - flush cut	341
impact sockets 3/8" drive	219	pliers - groove joint	343-345
impact sockets 1/2" drive	220-223	pliers - insulated	335
impact sockets 3/4" drive	225	pliers - long nose	335, 342
impact sockets 1" drive	226-227	pliers - long reach	343
impact sockets 1 1/2" drive	227	pliers - mini	346-347
impact TX bit sockets	223	pliers - pincers	345
impact wrenches	420-424	pliers - power grip	352-353
insert wrenches	290-291	pliers - round nose	343
inspection mirrors	401-402	pliers - self-locking	343
inspection tools	401-405	pliers - side cutters	335, 340
insulated tools	330-335	pliers - water pump	343-345
jackets	433-434	pliers - wire stripping	335, 396-397
keys	82	pliers - wire twisting	344
kneeling pads	405	podgers	263
knives	372-375	power grip pliers	352-353
lazy tongue rivet guns	415	power through screwdrivers	311
LED lamps	133, 404-405	precision screwdrivers	307-309
levels	429-430	precision tweezers	347
lights	133, 404-405	protective glasses	417, 431
LMP spanners	244	pry bars	382, 400
locks	82	pullers	392-394
long nose pliers	335, 342	punches	382, 411
long reach pliers	343	quick wrenches	263
luggage belts	437	racking system	140-143
luggage tags	437	ratchet service kits	183
lump hammers	407	ratchets - 1/4" drive	182
machine clamps	357	ratchets - 3/8" drive	182
magnetic bits tray	79, 401	ratchets - 1/2" drive	182-183
magnetic bracelets	402	ratchets - 3/4" drive	183
magnetic chargers	302	ratchets 1" drive	183
magnetic holders	79, 387	ratcheting bits drivers	317-318
magnetic pick ups	401-402	ratcheting combination spanners	240-243
magnetic shelves	78-79	ratcheting offset ring spanners	254
magnetic tool rails	76, 402	reamers	364-365
magnetic tool trays	79	retaining pins	218
magnifiers	402	retaining rings	218
masonry hammers	407	rethreading tools	369
measuring kits	427	retractable knives	372-373
measuring tapes	427-428	ribe sockets	201
mechanics creepers	406	rigger jiggers	244
mechanics stool	406	ring spanners	244-246, 254
mega master tool kits	14-38, 42-45	rivet guns	414-415
micrometers	427	roll bars	400
middle boxes	67-68	roller cabinets	68-72
midget wrenches	243	RORS wrenches	254
mini bits ratchets	182, 316	rules	428
mini pliers	346-347	safety glasses/goggles	417, 432
mini screwdrivers	306-309	safety wires	400-401
mirrors	401-402	saw blades	365, 366
modular racking system	140-143	saws	365-366, 425
monster tool kits	14-38, 42-45	scissors	361
mugs	438	scrapers	377, 378
neckers	432	screw clamps	354
needle files	390	screw extractors	397-398
nut drivers	261	screwdriver bit sets	314-318
nut sert tools	415	screwdriver bit sockets	194-195
nut setters	327	screwdriver bits	314-327
nut splitters	398	screwdriver sets	298-311, 330
oil filter removal tools	353, 380-381	screwdrivers - double ended	302, 307
oil service kits	380	screwdrivers - flat type	303, 307, 311, 332
open ended spanners	248	screwdrivers - hex type	273, 307
overalls	435	screwdrivers - insulated	330-334
palm ratchets	182	screwdrivers - mini	306-309
panels	121, 135	screwdrivers - PH type	304, 307, 311, 333
paper towel holders	81	screwdrivers - plus/minus	334
parallel pin punches	411	screwdrivers - power through	311
passport wallets	437	screwdrivers - PZ type	304, 333
pens	401, 437	screwdrivers - ROB type	306
pick up tools	399, 401-402	screwdrivers - TX/TPX type	306, 309
pin punches	411	scribers	411
pin wrenches	262-263	seat belt protector	431
pincers	345	self locking pliers	343
pipe cutters	362-363	service cases	56-58, 72
pipe wrenches	260	service kits	38-58
piston ring compressor	381	set squares	428
plastic carrying boxes	74	shelves	78, 143
plier sets	338-340	side cupboards	77
pliers - cable cutters	341-362	side cutting pliers	335, 340
pliers - circlip	348	side plates	83
pliers - combination	335, 341-342	side tables	81

INDEX CATEGORY	PAGE	INDEX CATEGORY	PAGE
sign boards	130, 440	TX keys	275-277
sliding T bars	189	TX-E sockets	194, 197, 202
slogging wrenches	252	TX-E wrenches	255
snap ring pliers	348-349	tyre levers	383
snoods	432	umbrellas	431
socket adaptors	188, 206, 326	universal joints	187, 218
socket clips	75	uprights	131, 134, 135
socket sets 1/4" drive	152-159	utility knives	372-375
socket sets 3/8" drive	160-167, 204-205	vinyl transfer stickers	440
socket sets 1/2" drive	168-177, 204-205	voltage testers	396
socket sets 3/4" drive	177	wagons	68-72
socket sets 1" drive	179	wall racks	146-149
sockets 1/4" drive	193-195	water bottles	438
sockets 3/8" drive	195-197, 207	water pump pliers	344-345
sockets 1/2" drive	198-202, 207	welding pliers	355-357
sockets 3/4" drive	203	welding tools	355-357, 387
sockets 1" drive	204	wheel nut sockets	384-385
soft face hammers	407	wheel nut wrenches	384
spanner rings	247	wheel tools	384-385
spanner sets	230-248	wheel wrenches	384
spanners	230-248	wheels	74, 79, 80
spark plug sockets	190, 379	window hinge wrenches	254
specialist sockets	387	wing covers	387
speed braces	189	wing TX bit sets	319
spinner handles	189	wire strippers	335, 396-397
spirit levels	429-430	wire twisting pliers	344
spline sockets	201, 221	wobble extension bars	187
squares	428-429	wood chisels	408
stainless steel socketry	204-207	wooden tops	80, 130, 135
starter kits	38-58	work bench panels	131-132, 135
stationery wallets	437	work bench uprights	131, 134, 135
steel rules	428	work benches	130-140
stickers	81, 440	wrenches, adjustable	258-259
stools	406, 439	wrenches, aluminium pipe	260
storage trays	86-88	wrenches, bi-flex	253
stubby wrenches	243	wrenches, double flex	253
stud extractors	397-398	wrenches, flare nut	253, 381
suction lifters	386	wrenches, hook	262-263
suit cases	436	wrenches, oil filter	353, 380-381
sun glasses	431	wrenches, pin	262-263
T5 bit sets	319	wrenches, pipe	260
T bar adaptors	187, 206	wrenches, slogging	252
T handles	261, 273-274, 277	wrenches, T handle	261, 273-274, 277
T shirts	432-433	wrenches, torque	282-289
table clamps	357	wrenches, wheel nut	384
tables	439	XZN sockets	201, 221
take away tool kits	56-58		
tap and die sets	367		
tap handles	369		
tape measures	427-428		
taps and dies	367-369		
teng collection	431-440		
tents	439		
tin snips	360		
tool box covers	80-81		
tool bags	73		
tool box handles	80		
tool box keys	82		
tool boxes	64-71		
tool kits	14-59		
tool mats	76		
tool storage	64-71		
tool trays	86-128		
top boxes	66-68		
torches	404-405		
torpedo levels	430		
torque multipliers	290		
torque screwdrivers	282		
torque sticks	223, 385		
torque wrenches	282-289		
torque wrench testers	280-281		
tote trays	75		
TPX bit sockets	198, 202		
TPX bits	325		
TPX drivers	277		
trimming knives	372-375		
trollies	140		
trousers	434		
tweezers	347		
TX bit sets	319		
TX bits	323-325		
TX bit sockets	195, 198, 202		
TX drivers	277		
TX impact sockets	223		



Code No.	Page No.	Code No.	Page No.
65RS12	241	705A	366
401-4	353	705A-5	366
401-5	353	710	374
401-7	353	710-10	374
401-10	353	710-10H	375
401-10F	353	710-100	374
401-12	353	710-100H	375
401-12F	353	710A	372
402	352	710A-10	372
404-4	353	710A-100	373
404-6	353	710C	373
404-6S	353	710F	372
404-9	353	710F-10	373
406	355	710F-100	373
406-6	355	710G	373
406-6P	356	710H	372
406-6S	356	710N	374
406-6SP	356	710S	372
406P	356	710U-10	373
406S	356	711	374
406SP	356	712	374
407	356	1200-72N	182
407AS	357	1200-72NRK	183
408	357	1200-72SN	182
409	353, 380	1200F	183
409P	357	1200FRK	183
409SP	357	1200FRP	182
410P	357	1200FRPRK	183
410SP	357	1200L	183
445W	340	1201	190
480	348	1201A	190
490	360	1201ARK	183, 190
490W	360	1201RK	183, 190
491	360	1202	384
491W	360	1202A	384
492	360	1292AG-090	287
492W	360	1292AG-110	287
493	360	1292AG-120	287
494	360	1292AG-140	287
495	360	1292AG4-CT	285
496	361	1292AG4R-CT	286
497	361	1292AG4RK	288
498-7	344	1292AG4RRK	288
580	401	1292AG-E4	285
580A	401	1292AG-E4R	285
580C	78	1292AG-EP	285
580CK	79	1292AG-ER	285
580CM	79	1292AGERK	288
580CN	79	1292AGERRK	288
580D	78	1292AGP-CT	285
580J	79	1292AGR-CT	286
580K	79	1292D200	287
580M	79	1292D200-CT	287
580N	79	1292P100	286
580Q	79	1292P100-CT	286
580R	79	1292P200	286
580S	401	1292P200-CT	286
581N	405	1292P320	286
581TMG	402	1292P320-CT	286
581TMI	402	1400-72N	182
581TMP	402	1400-72NRK	183
582MI	401	1400-72SN	182
582N	405	1400B	182, 316
583M	402	1400FRP	182
583N	405	1400FRPRK	183
585	404	1400M	182
585MP	401	1424	266
586	404	1425	266
586A	404	1471AF	268
586C	404	1471AFA	268
587H	403	1471MM	268
587J	133, 404	1471MMA	268
587M	403	1473	267, 383
589ME	133	1474	269
600	247	1475	269
700-PRO5	365	1476NAF	268
701	365	1476NMM	267
701N	365	1476NMM1	267
701N1	365	1476NTX	276
702	365	1476NTX1	276
703	366	1476NTX2	276
703-10	366	1477NX	267, 308
703-24	366	1479AF	270
704	366	1479MM	269
705	365	1479MMA	269
705-5	365	1479MMR	266



Code No.	Page No.	Code No.	Page No.
1479MMRL	267	6005M15	243
1479TX	274	6005M16	243
1479TX1	275	6005M17	243
1486	319	6005M18	243
1487	275	6005M19	243
1488	319	6059LMP	244
1492AG-CT	283	6208	247
1492AG-E	282	6211	248
1492AGERK	288	6211MM	248
1492SD	282	6308	245
1492SD-CT	282	6308MM	245
1499AF	270	6311	245
1499MM	269	6503RX	254
1499TX	276	6507AF	236
2300	399	6507JAF	236
3492AG1-CT	287	6507JMM	236
3492AG2-CT	287	6507JMMA	237
3492AG-CT	287	6508RMM	240
3492AG-E	287	6508RSMM	241
3492AG-E1	287	6509AF	236
3492AG-E2	287	6510A	233
3492AG-ER	288	6510MM	233
3492AGERK	288	6510RMM	240
3492AGERRK	288	6512	234
3492AGR-CT	288	6512MM	235
3492P500	288	6512MM1	234
3492P500-CT	288	6512MMA	237
3800-72N	182	6512N	234
3800-72NRK	183	6512RSMM	242
3800-72SN	182	6515MM	234
3800FRP	182	6515MMA	237
3800FRPRK	183	6517	235
3892AG1-CT	283	6517MM	234
3892AG1RK	288	6521	235
3892AG3-CT	283	6526MM	235
3892AG3RK	288	8512A	233
3892AG-E1	283	8512MM	233
3892AG-E3	283	9110	380
3892CQ100R	290	9110RK-1	380
3892D100	284	9120	380
3892D100-CT	284	9120HD	381
3892P060	284	9120RK-1	380
3892P060-CT	284	9121	210
3892P100	284	9123	380
3892P100-CT	284	9123RK	380
4001	258	9124	380
4001RK	258	9126	210
4002	258	9203N	385
4002IQ	258	9203N1	384
4002IQRK	259	9207S12	210
4002RK	258	9381	210
4002WT	259	9386	210
4002WTRK	259	9850	396
4003	258	120955-C	387
4003IQ	258	120970-C	387
4003IQRK	259	210705	322
4003J	259	210706	322
4003JRK	259	210707	322
4003RK	258	210708	322
4003WT	259	210709	322
4003WTRK	259	210710	322
4004	258	210712	322
4004IQ	258	210714	322
4004IQRK	259	210717	322
4004RK	258	210719	322
4004WT	259	210805	323
4004WTRK	259	210806	323
4005	258	210807	323
4005IQ	258	210808	323
4005IQRK	259	210809	323
4005RK	258	210810	323
4005WT	259	210812	323
4005WTRK	259	210814	323
4006	258	210817	323
4006IQ	258	210819	323
4006IQRK	259	220720	324
4006RK	258	220725	324
4007	258	220727	324
4007RK	258	220730	324
4008	258	220740	324
4008RK	258	220745	324
6005M10	243	220750	324
6005M11	243	220755	324
6005M12	243	220760	324
6005M13	243	220770	324
6005M14	243	220820	324



Code No.	Page No.	Code No.	Page No.
220825	324	390107BL	272
220827	324	390108BL	272
220830	324	390110BL	272
220840	324	390112BL	272
220845	324	390502BL	271
220850	324	390503BL	271
220855	324	390504BL	271
220860	324	390505BL	271
220870	324	390506BL	271
310102	271	390508BL	271
310103	271	390510BL	271
310103BL	271	390908BL	276
310104	271	390909BL	276
310104BL	271	390910BL	276
310105	271	390915BL	276
310105BL	271	390920BL	276
310106	271	390925BL	276
310106BL	271	390927BL	276
310107	271	390930BL	276
310107BL	271	390940BL	276
310108	271	510103	274
310108BL	271	510104	274
310110	271	510105	274
310110BL	271	510106	274
310112	271	510107	274
310112BL	271	510108	274
310114	271	510110	274
310116	271	510502	273
310502	270	510503	273
310502BL-C	271	510504	273
310503	270	510505	273
310503BL-C	271	510506	273
310504	270	510507	273
310504BL-C	271	510508	273
310505	270	510510	273
310505BL-C	271	510512	273
310506	270	510603	273
310506BL-C	271	510604	273
310507	270	510605	273
310507BL-C	271	510606	273
310508	270	510607	273
310508BL-C	271	510608	273
310509	270	520009	277
310510	270	520010	277
310510BL-C	271	520015	277
310512	270	520020	277
310514	270	520025	277
310517	270	520027	277
310519	270	520030	277
310522	270	520040	277
310527	270	520045	277
310532	270	520050	277
310536	270	520055	277
320008	275	600108	239
320008BL	275	600110	239
320009	275	600110R	242
320009BL	275	600112	239
320010	275	600112R	242
320010BL	275	600114	239
320015	275	600114R	242
320015BL	275	600116	239
320020	275	600116R	242
320020BL	275	600118	239
320025	275	600118R	242
320025BL	275	600120	239
320027	275	600120R	242
320027BL	275	600122	239
320030	275	600122R	242
320030BL	275	600124	239
320040	275	600124R	242
320040BL	275	600126	239
320045	275	600126R	242
320045BL	275	600128	239
320050	275	600128R	242
320050BL	275	600130	239
320502	270	600132	239
320503	270	600134	239
320504	270	600136	239
320505	270	600140	239
320506	270	600142	239
320508	270	600144	239
320510	270	600146	239
390103BL	272	600148	239
390104BL	272	600152	239
390105BL	272	600156	239
390106BL	272	600160	239



Code No.	Page No.	Code No.	Page No.
600506	238	600816	263
600507	238	600817	263
600507RF	243	600819	263
600508	238	600822	263
600508R	240	600824	263
600508RF	243	600827	263
600508RS	242	600830	263
600509	238	600832	263
600509R	240	601013	244
600509RF	243	605908	244
600509RS	242	605909	244
600510	238	605910	244
600510R	240	605911	244
600510RF	243	605912	244
600510RS	242	605913	244
600511	238	605914	244
600511R	240	605915	244
600511RF	243	605916	244
600511RS	242	605917	244
600512	238	605918	244
600512R	240	605919	244
600512RF	243	611214	253
600512RS	242	611618	253
600513	238	612022	253
600513R	240	620607	248
600513RF	243	620809	248
600513RS	242	621011	248
600514	238	621213	248
600514R	240	621415	248
600514RF	243	621617	248
600514RS	242	621819	248
600515	238	622022	248
600515R	240	622123	248
600515RF	243	622427	248
600515RS	242	623032	248
600516	238	630607	246
600516R	240	630809	246
600516RF	243	630810FL	247
600516RS	242	631011	246
600517	238	631113FL	247
600517R	240	631213	246
600517RF	243	631214FL	247
600517RS	242	631415	246
600518	238	631617	246
600518R	240	631618FL	247
600518RF	243	631719FL	247
600518RS	242	631819	246
600519	238	632022	246
600519R	240	632123	246
600519RF	243	632224FL	247
600519RS	242	632427	246
600520	238	633032	246
600520RS	242	641011	253, 381
600521	238	641213	253, 381
600521RS	242	641314	253, 381
600522	238	641617	253, 381
600522R	240	641922	253, 381
600522RS	242	650809	253
600523	238	651011	253
600524	238	651013	253
600524R	240	651213	253
600524RS	242	651415	253
600525	238	651617	253
600526	238	651819	253
600527	238	661416	253, 381
600527R	240	680607E	255
600528	238	680608	254
600529	238	680709	254
600530	238	680810E	255
600530R	240	681013	254
600532	238	681112E	255
600532R	240	681214	254
600533	238	681416E	255
600534	238	681719	254
600536	238	681820E	255
600538	238	682122	254
600541	238	682224E	255
600546	238	690510	291
600550	238	690511	291
600555	238	690512	291
600558	238	690513	291
600560	238	690514	291
600565	238	690515	291
600570	238	690516	291
600813	263	690517	291
600814	263	690518	291



Code No.	Page No.	Code No.	Page No.
690519	291	902090	252
690613	291	902095	252
690614	291	902100	252
690615	291	903024	252
690616	291	903027	252
690617	291	903030	252
690618	291	903032	252
690619	291	903036	252
690621	291	903038	252
690622	291	903041	252
690624	291	903046	252
690626	291	903050	252
690627	291	903055	252
690629	291	903060	252
690630	291	903065	252
690632	291	903070	252
690634	291	903075	252
690636	291	903080	252
690638	291	903085	252
690640	291	903090	252
690641	291	903095	252
690642	291	903100	252
690644	291	910086	218
690646	291	910504	215
690710	291	910505	215
690711	291	910506	215
690712	291	910508	215
690713	291	910510	215
690714	291	910524	226
690715	291	910527	226
690716	291	910530	226
690717	291	910532	226
690718	291	910533	226
690719	291	910534	226
690813	292	910536	226
690814	292	910538	226
690815	292	910541	226
690816	292	910546	226
690817	292	910550	226
690818	292	910555	226
690819	292	910560	226
690821	292	910565	226
690822	292	910570	226
690824	292	910575	226
690826	292	910580	226
690827	292	910585	226
690829	292	910590	226
690830	292	910595	226
690832	292	910624	226
690834	292	910627	226
690836	292	910627R	227
690838	292	910628	226
690840	292	910630	226
690841	292	910630R	227
690842	292	910632	226
690844	292	910632R	227
690846	292	910633	226
691406	253	910633R	227
800608	237	910636	226
800609	237	910732	227
800610	237	912041	227
800611	237	912046	227
800612	237	912050	227
800613	237	912055	227
800614	237	912060	227
800615	237	912065	227
800616	237	912070	227
800617	237	912075	227
800618	237	912080	227
800619	237	912085	227
902024	252	912090	227
902027	252	912095	227
902030	252	912100	227
902032	252	912105	227
902036	252	912110	227
902038	252	912115	227
902041	252	912120	227
902046	252	912125	227
902050	252	912130	227
902055	252	920001	215
902060	252	920002	215
902065	252	920003	215
902070	252	920020-C	218
902075	252	920020A-C	218
902080	252	920021-C	218
902085	252	920021A-C	218

Code No.	Page No.	Code No.	Page No.
920023-C	218	920617A-C	222
920023A-C	218	920618-C	222
920030-C	218	920618A-C	222
920030A-C	218	920619-C	222
920036-C	218	920619A-C	222
920036A-C	218	920621-C	222
920037-C	218	920621A-C	222
920037A-C	218	920622-C	222
920060-C	218	920622A-C	222
920114-C	221	920624-C	222, 387
920116-C	221	920624A-C	222
920118-C	221	920627-C	222, 387
920120-C	221	920628-C	222, 387
920122-C	221	920629-C	222, 387
920124-C	221	920630-C	222, 387
920126-C	221	920632-C	222, 387
920128-C	221	920635-C	222, 387
920130-C	221	920636-C	222, 387
920132-C	221	920710-C	221
920136-C	221	920712-C	221
920214-C	222	920713-C	221
920216-C	222	920714-C	221
920218-C	222	920715-C	221
920220-C	222	920716-C	221
920222-C	222	920717-C	221
920224-C	222	920718-C	221
920226-C	222	920719-C	221
920228-C	222	920721-C	221
920230-C	222	920722-C	221
920232-C	222	920724-C	221
920242-C	222, 387	921210TX-C	223
920248-C	222, 387	921215TX-C	223
920508-C	220	921220TX-C	223
920510-C	220	921225TX-C	223
920510A-C	220	921227TX-C	223
920511-C	220	921230TX-C	223
920511A-C	220	921240TX-C	223
920512-C	220	921245TX-C	223
920512A-C	220	921250TX-C	223
920513-C	220	921255TX-C	223
920513A-C	220	921260TX-C	223
920514-C	220	921270TX-C	223
920514A-C	220	921505-C	223
920515-C	220	921506-C	223
920515A-C	220	921508-C	223
920516-C	220	921510-C	223
920516A-C	220	921512-C	223
920517-C	220	921514-C	223
920517A-C	220	921517-C	223
920517N	385	921519-C	223
920518-C	220	923090	223, 385
920518A-C	220	923110	223, 385
920519-C	220	923120	223, 385
920519A-C	220	923140	223, 385
920519N	385	930001	215
920520-C	220	930002	215
920521-C	220	930003	215
920521A-C	220	930004	215
920521N	385	940006	215
920522-C	220	940008	215
920522A-C	220	940010	215
920523-C	220	940012	215
920524-C	220	940022-C	218
920524A-C	220	940030-C	218
920525-C	220	940037-C	218
920526-C	220	940085-C	218
920527-C	220	940258-C	387
920528-C	220	940519-C	225
920529-C	220	940521-C	225
920530-C	220	940522-C	225
920532-C	220	940523-C	225
920610-C	222	940524-C	225
920610A-C	222	940527-C	225
920611-C	222	940528-C	225
920611A-C	222	940530-C	225
920612-C	222	940532-C	225
920612A-C	222	940533-C	225
920613-C	222	940534-C	225
920613A-C	222	940536-C	225
920614-C	222	940538-C	225
920614A-C	222	940540-C	225
920615-C	222	940541-C	225
920615A-C	222	940546-C	225
920616-C	222	940550-C	225
920616A-C	222	940619-C	225
920617-C	222	940621-C	225



Code No.	Page No.	Code No.	Page No.
940622-C	225	6005055	238
940623-C	225	9291719	221, 384
940624-C	225	9292122	221, 384
940627-C	225	60050811RX	254
940630-C	225	60051215RX	254
940632-C	225	60051619RX	254
940633-C	225	AB200	429
940634-C	225	ABS-TOP	75
940636-C	225	ACC35CBH01	326
940638-C	225	ACC50CBH01	326
940641-C	225, 387	ACC50MBH01	326
940646-C	225	ACC70MBH01	326
940650-C	225	ACC300CBH01	326
940732-C	226	ACCSDA1412	326
941519-C	225	ACCSDA1414	326
941522-C	225	ACCSDA1438	326
941524-C	225	ACD01	289
960506-C	219	ALU12	75
960507-C	219	ALU14	75
960508-C	219	ALU34	75
960510-C	219	ALU38	75
960513-C	219	ALU430	75
970030	215	ALU450	75
970040	215	ALU1000-1	75
970045	215	ALU1000-4	75
970050	215	ARB01	426
970055	215	ARB02	426
980020-C	217	ARB03	426
980035-C	217	ARD10	425
980036A-C	217	ARD13	425
980036-C	217	ARG01	426
980060-C	217	ARG02	426
980086	217	ARR12	424
980508-C	219	ARRM38	424
980510-C	219	ARS01	425
980511-C	219	ARWC12	422
980512-C	219	ARWC34	422
980513-C	219	ARWC38	421
980514-C	219	ARWM11S	424
980515-C	219	ARWM12	420
980516-C	219	ARWM12M	423
980517-C	219	ARWM34	421
980519-C	219	ARWM38	420
980608-C	219	AT005	381
980610-C	219	AT020	381
980611-C	219	AT040	381
980612-C	219	AT040-SM	381
980613-C	219	AT080	378
980614-C	219	AT085	378
980616-C	219	AT090	378
980617-C	219	AT096	343
980619-C	219	AT097	343
981504-C	219	AT135	399
981505-C	219	AT135M	399
981506-C	219	AT160	382
981507-C	219	AT170	382
981508-C	219	AT180	382
981510-C	219	AT180-S	382
981512-C	219	AT186	383
2912512	307	AT191	383
2912513	307	AT192	383
2912514	307	AT194	383
2912520	307	AT195	383
2912535	307	AT200	383
2912537	307	AT330	382
2912539	307	AT350	387
3101025	271	AT355	387
3101025BL	271	AT360	387
3101035	271	AT365	387
3101045	271	AT370	387
3105007	270	AT375	387
3105009	270	AT380	387
3105013	270	AT415	386
3105015	270	AT420	386
3105015BL-C	271	AT500	389
3105025	270	AT505	389
3105025BL-C	271	AT605	344
3105045	270	AT20512	383
3105055	270	AT20516	383
3205015	270	AT20520	383
3205025	270	AT20524	383
3901025BL	272	BBX10A	314
3905015BL	271	BC408	341
3905025BL	271	BC408T	341
5105025	273	BC414	361
5106025	273	BC414J	361



Code No.	Page No.	Code No.	Page No.
BC418	361	DBX105	367
BC418J	361	DBX110	367
BC424	361	DBX115	367
BC424J	361	DBX120	367
BC430	361	DBX125	367
BC430J	361	DBX130	367
BC436	361	DET01	364
BC436J	361	DET01RK	364
BWT406	260	DET02	365
CAL150D	427	DHW1300	254
CC150F	409	DHW1417	254
CC200F	409	DHW1922	254
CC240F	409	DIE-HNDL	369
CC250F	409	DIS-SP05	393
CMD12	354	DIS-SP05Q	394
CMD16	354	DP0810	381
CMD20	354	DP0812	381
CMD25	354	DP1012	381
CMD30	354	DP1112	381
CMD30A	354	DP1314	381
CMD40	354	DP1716	381
CMD40A	354	EVA-01	128
CMD50	354	FC01	387
CMD80	354	FG21	377
CMF16	354	FL2506A03	319
CMF16T	354	FL2506B03	319
CMF20	354	FL2508A03	319
CMF20T	354	FL2508B03	319
CMF25	354	FL2510A03	319
CMF25T	354	FL2512A03	319
CMF30	354	FL2516A03	319
CMF30T	354	FL5006A03	319
CMF35	354	FL5008A03	319
CMF35T	354	FL5008B03	319
CMFQ20	354	FL5010A03	319
CMFQ25	354	FL5012A03	319
CMFQ30	354	FL7006A02	320
CMFQ40	354	FL7008A02	320
CMQ150	355	FL7008B02	320
CMQ300	355	FL7010A02	320
CMQ450	355	FLFT10	391
CMQ600	355	FLHF10	391
CMQL150	355	FLHR10	391
CMQL300	355	FLRD10	391
CMQL450	355	FLSQ10	391
CP04	411	FLTR10	391
CP04RK1	395	FTF4055	302
CP04RK2	395	FTF32406005	319
CP04RK3	395	GR25002010	321
CP05	411	GR25002100	321
CP08	411	GRP3000201	216, 321
CP50	395	GRP3000205	216, 321
CP51	395	GRP5000201	216, 321
CP52	395	HBH0303	302
CP53	397	HBH0404	302
CP55	396	HBH0505	302
CP58	395	HBH0606	302
CP60	397	HEX2500203	322
CTG01	396	HEX2500303	322
DB028	366	HEX2500403	322
DB034	367	HEX2500503	322
DBT35	364	HEX2500603	322
DBT41	364	HEX2500803	322
DBT54	364	HEX5000403	322
DBX010	367	HEX5000503	322
DBX015	367	HEX5000603	322
DBX020	367	HEX5000803	322
DBX025	367	HEXP3000301	216, 323
DBX030	367	HEXP3000305	216, 323
DBX033	367	HEXP3000401	216, 323
DBX035	367	HEXP3000405	216, 323
DBX040	367	HEXP3000501	216, 323
DBX042	367	HEXP3000505	216, 323
DBX045	367	HEXP3000601	216, 323
DBX050	367	HEXP3000605	216, 323
DBX055	367	HEXP5000301	216, 323
DBX060	367	HEXP5000401	216, 323
DBX065	367	HEXP5000501	216, 323
DBX068	367	HEXP5000601	216, 323
DBX070	367	HMBH01	386
DBX075	367	HMBH02	386
DBX080	367	HMBH03	386
DBX085	367	HMBH16	407
DBX090	367	HMBP12	406
DBX095	367	HMBP16	406
DBX100	367	HMBP24	406



Code No.	Page No.	Code No.	Page No.
HMBP32	406	M3814	159, 167
HMCH08A	406	M3816	167
HMCH13A	406	M110010	183
HMCH16A	406	M110020	183
HMCH16M	407	M110030	187
HMCH20A	406	M110040	186
HMCHC16	407	M110050	186
HMCHM16	407	M110070	190
HMDH35	386	M110070RK	190
HMDH45	386	M110536	204
HMDH55	386	M110541	204
HMDH65	386	M110546	204
HMEG300	406	M110550	204
HMEG500	406	M110555	204
HMEG800	406	M110558	204
HMS1250	407	M110560	204
HMSF	407	M110565	204
HMSFRK	407	M110570	204
HN02	415	M110575	204
HN02RK	415	M110580	204
HP101	262	M120010-C	190
HP102	262	M120011-C	189
HP103	262	M120020-C	186
HP2014	263	M120020W-C	187
HP2014-P	263	M120021-C	186
HP2015	263	M120021W-C	187
HP2015-P	263	M120022-C	186
HP2025	263	M120022W-C	187
HP2026	263	M120023-C	186
HP2026-P	263	M120024-C	187
HP2036	263	M120030-C	187
HP2036-P	263	M120036-C	187
HP2038	263	M120037-C	187
HP2038-P	263	M120037M	188
HR01	414	M120040-C	190, 379
HR01RK	414	M120042-C	190, 379
HR12	414	M120046-C	190, 379
HR12RK	414	M120050-C	189
HR14	414	M120060-C	188, 326
HR14RK	414	M120061-C	188, 326
HR30R	414	M120062-C	188, 326
HR30RRK-2	414	M120063-C	188, 326
HR360R	414	M120080-C	192
HRLN65N	415	M120112-C	199
HRLN65NRK-1	415	M120114-C	199
HRLR01	415	M120116-C	199
HRLR01RK-2	415	M120118-C	199
HRLT01	415	M120120-C	199
HRLT01RK	415	M120122-C	199
ID506	214	M120124-C	199
ID506BIT	214	M120126-C	199
ID515	215	M120128-C	199
ID515BIT	215	M120130-C	199
KP01	405	M120132-C	199
KP02	405	M120134-C	199
KP03	405	M120136-C	199
M1100	183	M120138-C	199
M1100-72	183	M120140-C	199
M1100-72RK	183	M120508-C	198
M1100RK	183	M120509-C	198
M1115MM	179	M120510-C	198
M1207	175	M120511-C	198
M1208-6	176	M120512-C	198
M1209AF	176	M120513-C	198
M1210	176	M120514-C	198
M1211	176	M120515-C	198
M1212	176	M120516-C	198
M1212N1	168	M120517-C	198
M1213TPX	177	M120518-C	198
M1213TX	177	M120519-C	198
M1215AF	175	M120520-C	198
M1215MM	175	M120521-C	198
M1407	159	M120522-C	198
M1408TX	159	M120523-C	198
M1410T5	319	M120524-C	198
M1412	159	M120525-C	198
M1413N1	152	M120526-C	198
M3400-72	183	M120527-C	198
M3400-72RK	183	M120528-C	198
M3807	167	M120529-C	198
M3808MM	260	M120530-C	198
M3811	167	M120532-C	198
M3812	167	M120534-C	198
M3812N1	160	M120610-C	199
M3813TPX	167	M120611-C	199
M3813TX	167	M120612-C	199



Code No.	Page No.	Code No.	Page No.
M120613-C	199	M122705-C	201
M120614-C	199	M122706-C	201
M120615-C	199	M122708-C	201
M120616-C	199	M122709-C	201
M120617-C	199	M122710-C	201
M120618-C	199	M122711-C	201
M120619-C	199	M122712-C	201
M120620-C	199	M122713-C	201
M120621-C	199	M122805-C	201
M120622-C	199	M122806-C	201
M120624-C	199	M122808-C	201
M120627-C	199	M122809-C	201
M120630-C	199	M122810-C	201
M120632-C	199	M122812-C	201
M120636-C	199	M122814-C	201
M120710-C	202	M122816-C	201
M120711-C	202	M123814-C	221
M120712-C	202	M123816-C	221
M120714-C	202	M123818-C	221
M120716-C	202	M140015-C	189
M120718-C	202	M140020-C	186
M120720-C	202	M140021-C	186
M120722-C	202	M140022-C	186
M120724-C	202	M140023-C	186
M121106-C	201	M140024-C	187
M121107-C	201	M140030-C	187
M121108-C	201	M140036-C	187
M121109-C	201	M140036M	188
M121110-C	201	M140037	187
M121112-C	201	M140038-C	186
M121116-C	201	M140050-C	189
M121118-C	201	M140060-C	188, 326
M121120-C	201	M140070	369
M121220-C	201	M140071	369
M121220T-C	202	M140072	369
M121225-C	201	M140106-C	193
M121225T-C	202	M140107-C	193
M121227-C	201	M140108-C	193
M121227T-C	202	M140109-C	193
M121230-C	201	M140110-C	193
M121230T-C	202	M140111-C	193
M121240-C	201	M140112-C	193
M121240T-C	202	M140114-C	193
M121245-C	201	M140116-C	193
M121245T-C	202	M140206-C	194
M121250-C	201	M140207-C	194
M121250T-C	202	M140208-C	194
M121255-C	201	M140209-C	194
M121255T-C	202	M140210-C	194
M121260-C	201	M140211-C	194
M121260T-C	202	M140212-C	194
M121505-C	200	M140214-C	194
M121506-C	200	M140216-C	194
M121507-C	200	M140504-C	193
M121508-C	200	M140505-C	193
M121509-C	200	M140506-C	193
M121510-C	200	M140507-C	193
M121512-C	200	M140508-C	193
M121514-C	200	M140509-C	193
M121517-C	200	M140510-C	193
M121519-C	200	M140511-C	193
M121814-C	221	M140512-C	193
M121816-C	221	M140513-C	193
M121818-C	221	M140604-C	193
M122220T-C	202	M140605-C	193
M122225T-C	202	M140606-C	193
M122227T-C	202	M140607-C	193
M122230T-C	202	M140608-C	193
M122240T-C	202	M140609-C	193
M122245T-C	202	M140610-C	193
M122250T-C	202	M140611-C	193
M122255T-C	202	M140612-C	193
M122260T-C	202	M140613-C	193
M122270T-C	202	M140704-C	194
M122505-C	200	M140705-C	194
M122506A-C	200	M140706-C	194
M122506-C	200	M140707-C	194
M122507-C	200	M140708-C	194
M122508A-C	200	M141210T-C	195
M122508-C	200	M141215T-C	195
M122510-C	200	M141220T-C	195
M122510L-C	200	M141225T-C	195
M122512-C	200	M141227T-C	195
M122514-C	200	M141230T-C	195
M122517-C	200	M141240T-C	195
M122704-C	201	M141300-C	194



Code No.	Page No.	Code No.	Page No.
M141301-C	194	M380224-C	196
M141302-C	194	M380226-C	196
M141303-C	194	M380228-C	196
M141404-C	194	M380507-C	195
M141407-C	194	M380508-C	195
M141601-C	195	M380509-C	195
M141602-C	195	M380510-C	195
M141603-C	195	M380511-C	195
M340020-C	186	M380512-C	195
M340020S-C	186	M380513-C	195
M340021-C	186	M380514-C	195
M340021S-C	186	M380515-C	195
M340022-C	186	M380516-C	195
M340022S-C	186	M380517-C	195
M340030-C	187	M380518-C	195
M340050-C	189	M380519-C	195
M340050S-C	189	M380520-C	195
M340070-C	190	M380521-C	195
M340070RK	190	M380522-C	195
M340070S-C	190	M380607-C	196
M340070SRK	190	M380608-C	196
M340085-C	187	M380609-C	196
M340085M	188	M380610-C	196
M340086-C	187	M380611-C	196
M340124-C	203	M380612-C	196
M340128-C	203	M380613-C	196
M340130-C	203	M380614-C	196
M340132-C	203	M380615-C	196
M340134-C	203	M380616-C	196
M340136-C	203	M380617-C	196
M340138-C	203	M380618-C	196
M340140-C	203	M380619-C	196
M340142-C	203	M380620-C	196
M340144-C	203	M380621-C	196
M340146-C	203	M380622-C	196
M340148-C	203	M380710-C	197
M340152-C	203	M380712-C	197
M340156-C	203	M380714-C	197
M340158-C	203	M380716-C	197
M340160-C	203	M380718-C	197
M340164-C	203	M381103-C	197
M341514-C	203	M381104-C	197
M341517-C	203	M381105-C	197
M341519-C	203	M381106-C	197
M341522-C	203	M381107-C	197
M380010A-C	190	M381108-C	197
M380011-C	189	M381110-C	197
M380015-C	189	M381112-C	197
M380020-C	186	M381210-C	198
M380020W-C	187	M381210T-C	198
M380021-C	186	M381215-C	198
M380021W-C	187	M381215T-C	198
M380022-C	186	M381220-C	198
M380022W-C	187	M381220T-C	198
M380023-C	186	M381225-C	198
M380024-C	187	M381225T-C	198
M380030-C	187	M381227-C	198
M380035-C	187	M381227T-C	198
M380036-C	187	M381230-C	198
M380036M	188	M381230T-C	198
M380037	187	M381240-C	198
M380039-C	190, 379	M381240T-C	198
M380040-C	190, 379	M381245-C	198
M380041-C	190, 379	M381245T-C	198
M380042-C	190, 379	M381250-C	198
M380046-C	190, 379	M381250T-C	198
M380047-C	190, 379	M381503-C	197
M380050-C	189	M381504-C	197
M380060-C	188, 326	M381505-C	197
M380061-C	188, 326	M381506-C	197
M380110-C	195	M381507-C	197
M380112-C	195	M381508-C	197
M380114-C	195	M381510-C	197
M380116-C	195	M381512-C	197
M380118-C	195	M386510-C	260
M380120-C	195	M386511-C	260
M380122-C	195	M386512-C	260
M380124-C	195	M386513-C	260
M380126-C	195	M386514-C	260
M380128-C	195	M386515-C	260
M380212-C	196	M386516-C	260
M380214-C	196	M386517-C	260
M380216-C	196	M386518-C	260
M380218-C	196	M386519-C	260
M380220-C	196	M1205106-C	199
M380222-C	196	M1205116-C	199



Code No.	Page No.	Code No.	Page No.
M1205126-C	199	MB461-6T	342
M1205136-C	199	MB461-8	342
M1205146-C	199	MB461-8T	342
M1205156-C	199	MB463-5	342
M1205166-C	199	MB463-6	342
M1205176-C	199	MB463-8	342
M1205186-C	199	MB463-8T	342
M1205196-C	199	MB464-6	343
M1205206-C	199	MB464-6T	343
M1205216-C	199	MB465-6	343
M1205226-C	199	MB470-5	349
M1205236-C	199	MB470-7	349
M1205246-C	199	MB470-9	349
M1205256-C	199	MB471-5	349
M1205266-C	199	MB471-7	349
M1205276-C	199	MB471-9	349
M1205286-C	199	MB472-5	349
M1205296-C	199	MB472-7	349
M1205306-C	199	MB472-9	349
M1205326-C	199	MB473-5	349
M1205336-C	199	MB473-7	349
M1205346-C	199	MB473-9	349
M1206136-C	200	MB481-7	343
M1206146-C	200	MB481-7T	343
M1206156-C	200	MB481-10	343
M1206166-C	200	MB481-10Q	344
M1206176-C	200	MB481-10T	343
M1206186-C	200	MB481-10TQ	344
M1206196-C	200	MB482-10Q	344
M1206246-C	200	MB489-7	345
M1405045-C	193	MB489-8	345
M1405055-C	193	MB499-7T	344, 396
M1406055-C	193	MB541-5	341
M1414055-C	194	MB541-6	341
M3405196-C	203	MB541-7	341
M3405216-C	203	MBE470-7	348
M3405226-C	203	MBE471-7	348
M3405246-C	203	MBE472-7	348
M3405266-C	203	MBE473-7	348
M3405276-C	203	MBM441	346
M3405306-C	203	MBM449	346
M3405326-C	203	MBM461	346
M3405336-C	203	MBM464	346
M3405346-C	203	MBM467	346
M3405366-C	203	MBM468	347
M3405386-C	203	MBM469	347
M3405416-C	203	MBV441-6	335
M3405466-C	203	MBV442-8	335
M3405506-C	203	MBV451-7	335
M3815055-C	197	MBV451-8	335
MB410	345	MBV461-8	335
MB412	345	MBV499-7	335, 396
MB416	345	MD503N	376
MB441-5	340	MD503NA	376
MB441-5T	340	MD503ND	376
MB441-6	340	MD503RK	376
MB441-6T	340	MD514L	189
MB442-5	340	MD514N	189
MB442-6	340	MD610TPN	306
MB442-6T	340	MD615TPN	306
MB442-7	340	MD620TPN	306
MB442-7S	340	MD625TPN	306
MB442-8	340	MD627TPN	306
MB442-8T	340	MD630TPN	306
MB442B-8T	340	MD640TPN	306
MB444-6	341, 362	MD801N	306
MB444-8	341, 362	MD802N	306
MB444-8T	341, 362	MD803N	306
MB444-10	341, 362	MD900	316
MB445-10	341, 362	MD901	302
MB448-6	345	MD906N	299
MB448-8	345	MD906N1	304
MB449-9	345	MD906N2	299, 305
MB449-10	345	MD906N3	299
MB449-11	345	MD906N4	299
MB451-7	341	MD906TN	306
MB451-8	341	MD907FL	316
MB452-6	342	MD907TN	306
MB452-6T	342	MD908N	316
MB452-7	342	MD908TN	306
MB452-7T	342	MD909TN	306
MB452-8	342	MD910N	298
MB452-8T	342	MD910TN	306
MB452-9	342	MD912N	298
MB461-5	342	MD912N1	298, 330
MB461-6	342	MD914N	303



Code No.	Page No.	Code No.	Page No.
MD915N	303	MDM706	307
MD915N1	303	MDM706TX	309
MD915TN	306	MDM706TXT	309
MD916N	303	MDM711	307
MD916N1	303	MDM712	307
MD916N2	303	MDM713	307
MD917N	303	MDM714	307
MD917N1	303	MDM715	307
MD917N2	303	MDM716	308
MD920N	303	MDM717	308
MD920N1	303	MDM718	308
MD920TN	306	MDM806	309
MD922N	303	MDM806T	309
MD923N	303	MDM807	309
MD923N1	303	MDM807T	309
MD925TN	306	MDM808	309
MD927TN	306	MDM808T	309
MD928N	303	MDM809	309
MD928N1	303	MDM809T	309
MD928N2	303	MDM810	309
MD928N3	303	MDM810T	309
MD928N4	303	MDM815	309
MD928N5	303	MDM815T	309
MD928N6	303	MDMC702N	299
MD928N7	303	MDMC715N	304
MD930N	303	MDMC718N	303
MD930TN	306	MDN405	261
MD931N	303	MDN406	261
MD932N	303	MDN407	261
MD932N1	303	MDN408	261
MD932N2	303	MDN410	261
MD934N	303	MDN411	261
MD935N	303	MDN412	261
MD940N	304	MDN413	261
MD940N1	304	MDN4055	261
MD940TN	306	MDNT405	261
MD945TN	306	MDNT406	261
MD947N	304	MDNT407	261
MD947N1	304	MDNT408	261
MD947N2	304	MDNT409	261
MD948N	304	MDNT410	261
MD948N1	304	MDNT411	261
MD948N2	304	MDNT412	261
MD948N3	304	MDNT413	261
MD948N4	304	MDNT414	261
MD948N5	304	MDNT4055	261
MD948N6	304	MDR908	318
MD948N8	304	MDR908S	317
MD949N	304	MDR915	318
MD950N	304	MDRT908	318
MD952N	304	MD-SCR	377, 378
MD952N1	304	MDT932N	311
MD953N	304	MDT934N	311
MD954N	304	MDT935N	311
MD960N	304	MDT952N	311
MD961N	304	MDT953N	311
MD961N1	304	MDV724N	332
MD961N2	304	MDV726N	332
MD962N	304	MDV742N	332
MD962N1	304	MDV744N	332
MD962N2	304	MDV762N	333
MD962N3	304	MDV764N	333
MD962N4	304	MDV802N	334
MD962N4A	304	MDV820N	332
MD962N4C	304	MDV822N	332
MD962N4D	304	MDV823N	332
MD962N5	304	MDV824N	332
MD963N	304	MDV826N	332
MD964N	304	MDV828N	332
MD7020HBN	274	MDV840N	332
MD7020HN	273	MDV842N	332
MD7025HBN	274	MDV844N	332
MD7025HN	273	MDV844NF	334
MD7030HBN	274	MDV846N	332
MD7030HN	273	MDV860N	333
MD7040HBN	274	MDV862N	333
MD7050HBN	274	MDV864N	333
MD7060HBN	274	MDV864NF	334
MD7080HBN	274	MDV866N	333
MD9053N	298	MDV906N	330
MDA-R	377	MDV9855	396
MDA-SQ	377	MH75	387
MDBH	316	MH90	387
MDH-L	377	MIR050	427
MDH-S	377	MP1400	290
MDM700	307	MP1400RK-1	290

Code No.	Page No.	Code No.	Page No.
MP2700	290	P90328	218
MP2700RK-1	290	P90332	218
MP91500	290	P90433	218
MP91500RK	290	P90435	218
MPSL01	290	P90437	218
MPSL02	290	P90445	218
MR500	302	P90543	218
MS1200	183, 206	P90545	218
MS1200RK	183, 206	P90551	218
MS1203	205	P90675	218
MS1213	205	P902515	218
MS3800	183, 206	P902518	218
MS3800RK	183, 206	P906110	218
MS3814	205	PB12	400
MS120021-C	206	PB12A	382, 400
MS120036-C	206	PB16	400
MS380020-C	206	PB18A	382, 400
MS380023-C	206	PB20	400
MS380036-C	206	PB22A	382, 400
MS380508-C	207	P-BCHR	439
MS380509-C	207	P-BET01	432
MS380510-C	207	P-BH	438
MS380511-C	207	P-BM	436
MS380512-C	207	P-BP	436
MS380513-C	207	P-BP2	436
MS380514-C	207	P-BT	439
MS380515-C	207	P-CAP6	431
MS380516-C	207	P-CAP7	431
MS380517-C	207	P-CAP8	431
MS380518-C	207	P-CB	435
MS380519-C	207	PCCAP	409
MS1205106-C	207	P-COP02	438
MS1205116-C	207	P-CS	439
MS1205126-C	207	P-CUP15	438
MS1205136-C	207	PCX05	409
MS1205146-C	207	P-EZP	435
MS1205156-C	207	P-FC16A	436
MS1205166-C	207	P-FC16AB	436
MS1205176-C	207	P-FC16B	436
MS1205186-C	207	P-FT17	438
MS1205196-C	207	PGW1719	263
MS1205216-C	207	PGW1922	263
MS1205246-C	207	PGW2124	263
MS1206176-C	207	PGW2730	263
MS1206196-C	207	PH2500103	320
MS1206216-C	207	PH2500110	320
MT03	427	PH2500203	320
MT03MM	427	PH2500210	320
MT05	427	PH2500303	320
MT05MM	427	PH2500310	320
MT08	427	PH5000103	320
MT08MM	427	PH5000203	320
MT10	428	PH5000303	320
MT15	428	PH7000102	320
MT30	428	PH7000202	320
MTS30	428	PHF0365	302
MTS50	428	PHH0102	302
MX04	188	PHH32000305	320
NS02	398	PHH32010205	320
NS45108M	327	P-HN11	432
NS45506M	327	PHP3000101	216, 321
NS45507M	327	PHP3000105	216, 321
NS45508M	327	PHP3000201	216, 321
NS45508R	327	PHP3000205	216, 321
O92416	218	PHP3000301	216, 321
O92419	218	PHP3000305	216, 321
O93525	218	PHP5000101	216, 321
O93528	218	PHP5000201	216, 321
O93530	218	PHP5000301	216, 321
O93532	218	PHP8900201	216, 321
O93534	218	P-LB	437
O93538	218	P-LT	437
O93546	218	POS-CH3032	434
O93548	218	POS-CH3034	434
O95034	218	POS-CH3232	434
O95036	218	POS-CH3234	434
O95046	218	POS-CH3432	434
O95775	218	POS-CH3434	434
O97043	218	POS-CH3632	434
O97045	218	POS-CH3634	434
O97051	218	POS-CH3832	434
O910075	218	POS-CH3834	434
O935202	218	POS-CH4032	434
O9100115	218	POS-CH4034	434
P90320	218	POS-HOODL	433
P90324	218	POS-HOODM	433



Code No.	Page No.	Code No.	Page No.
POS-HOODS	433	PW14A	260
POS-HOODXL	433	PW18A	260
POS-HOODXS	433	PW24A	260
POS-HOODXXL	433	PW36A	260
POS-HOODXXXL	433	P-WSB14	438
POS-OVERBL	435	PZ2500103	321
POS-OVERBM	435	PZ2500110	321
POS-OVERBXL	435	PZ2500203	321
POS-OVERBXXL	435	PZ2500210	321
POS-OVERRL	435	PZ2500303	321
POS-OVERRM	435	PZ2500310	321
POS-OVERRXL	435	PZ5000103	321
POS-OVERRXXL	435	PZ5000203	321
POS-POLOBL	433	PZ5000303	321
POS-POLOBM	433	PZ7000102	322
POS-POLOBS	433	PZ7000202	322
POS-POLOBXL	433	PZP3000101	216, 322
POS-POLOBXS	433	PZP3000105	216, 322
POS-POLOBXXL	433	PZP3000201	216, 322
POS-POLOBXXXL	433	PZP3000205	216, 322
POS-POLORL	433	PZP3000301	216, 322
POS-POLORM	433	PZP3000305	216, 322
POS-POLORS	433	PZP5000101	216, 322
POS-POLORXL	433	PZP5000201	216, 322
POS-POLORXS	433	PZP5000301	216, 322
POS-POLORXXL	433	PZP8900201	216, 322
POS-POLORXXXL	433	PZZ0102	302
POS-SOFTBL	434	PZZ32000305	321
POS-SOFTBM	434	PZZ32010205	321
POS-SOFTBS	434	ROB2500103	325
POS-SOFTBXL	434	ROB2500203	325
POS-SOFTBXS	434	ROB2500303	325
POS-SOFTBXXL	434	ROBP3000101	217, 325
POS-SOFTBXXXL	434	ROBP3000105	217, 325
POS-TSBKL	432	ROBP3000201	217, 325
POS-TSBKM	432	ROBP3000205	217, 325
POS-TSBKS	432	ROBP5000101	217, 325
POS-TSBKXL	432	ROBP5000201	217, 325
POS-TSBKXXL	432	ROBP5000301	217, 325
POS-TSRL	433	RSD070004	143
POS-TSRM	433	RSD135004	143
POS-TSRS	433	RSK0700	140
POS-TSRXL	433	RSK0700A	141
POS-TSRXXL	433	RSK1350	140
POS-TSWHL	432	RSK1350A	141
POS-TSWHM	432	RSKC02	141
POS-TSWHS	432	RSRU01	143
POS-TSWHXL	432	RSS0700	143
POS-TSWHXXL	432	RSS1350	143
POS-WT3031	434	RSSC01	143
POS-WT3033	434	RSSS700	143
POS-WT3231	434	RSSS1350	143
POS-WT3233	434	SC01	56
POS-WT3431	434	SC02	56
POS-WT3433	434	SC03	57
POS-WT3631	434	SC04	57
POS-WT3633	434	SC04E	58
POS-WT3831	434	SC058B	58
POS-WT3833	434	SC083B	59
POS-WT4031	434	SCP01	411
POS-WT4033	434	SCPS01	59, 113, 388
POS-WT4231	434	SCPS01E	59, 113, 389
POS-WT4233	434	SCR01	411
PP03	411	SD501	402
PP04	411	SE05	397
PP05	411	SEL01S	398
PP06	411	SEL02S	398
PP07	411	SEL03S	398
PP08	411	SEL04S	398
P-PENBK15	437	SEL05S	398
P-PENR2015	437	SG001	431
P-PS	431	SG002	431
PPS06	411	SG003	431
P-PW	437	SG713	417
P-SG01	432	SG713G	417
P-SG02	432	SG960	417
P-SG03	432	SG960A	417
P-SW	437	SG960G	417
PT3810R	189	SG960Y	417
P-TENT	439	SL01	386
P-TENTW	439	SL02	386
P-TF01	440	SL03	386
P-TS01	440	SLA040	429
P-UKF	373	SLA0300	429
P-UMB16	431	SLA0400	429
PW12A	260	SLA0600	429

Code No.	Page No.	Code No.	Page No.
SLA1000	429	ST-ORGANISED	440
SLA1200	429	STR01	384
SLA1500	429	ST-R130	440
SLA1800	429	ST-R130BK	440
SLA2000	429	ST-R130W	440
SLC0400	430	ST-R200	440
SLC0600	430	ST-R400	440
SLC0800	430	ST-R400BK	440
SLC1000	430	ST-R400W	440
SLC1200	430	ST-TTP01	81
SLC1500	430	T1206	211
SLC1800	430	T1220AF	168
SLC2000	430	T1221	168
SLM0300	430	T1221-6	168
SLM0400	430	T1230	169
SLM0600	430	T1234	169
SLM1000	430	T1268	51, 169
SLM1200	430	T1272	155, 169
SLP1160	343	T1419	152, 315
SLP2180	343	T1420	152, 315
SLP3160	343	T1422	152
SLP3180	343	T1423	153
SLT01	430	T1424	153
SLT02	430	T1424S	153
SP11	392	T1435AF	153
SP22	392	T1436	154
SP1410	392	T1460	154
SP1410Q	393	T3418-6	177
SP1810	392	T3422S	177
SP1810Q	393	T3834	160
SP2215	392	T3834S	160
SP2215Q	393	T3835AF	160
SP2615	392	T3839	161
SP2615Q	393	T3840	161
SP3320	392	T3848	50, 161
SP3320Q	393	T3867	50, 162
SP31410	393	TAP-HNDL	369
SP31410Q	394	TBSKT07	197, 262
SP31810	393	TBSKT08	197, 262
SP31810Q	394	TBSKT10	197, 262
SP32215	393	TBSKT12	197, 262
SP32215Q	394	TBSKT13	197, 262
SP32615	393	TBSKT14	197, 262
SP32615Q	394	TBSKT17	197, 262
SP33320	393	TBSKT19	197, 262
SP33320Q	394	TBUSP14	192, 379
SPA11	392	TBUSP16	192, 379
SPA22	392	TBUSP21	192, 379
SPBP20	378	TBW10	196, 262
SQA090	429	TC-3	73
SQAA200	428	TC-4	73
SQAA250	428	TC-4SBL	73
SQAA300	428	TC045B	49
SQAP250	428	TC082B	39
SQAP300	428	TC-90CLOCK	82
SR1160	361	TC103NF	66
SR1180	361	TC144D	48
SR2180	361	TC144E	49
SR3160	361	TC-160UR	134
SSH01	400	TC-180CLOCK	82
SSH02	400	TC187	50
SSH03	400	TC450	74
SSH04	401	TC540	74
ST150	428	TC-540W	74
ST200	428	TC803N	67
ST12319	399	TC803NBK	68
ST12321	399	TC803SV	68
ST12322	399	TC805NFX	66
ST12324	399	TC805SV	66
ST12325	399	TC806NF	66
ST12506-C	398	TC806NGM	67
ST12508-C	398	TC806SV	67
ST12510-C	398	TC810N	67
ST12512-C	398	TC816STACK	64
ST38112	398	TC816SV	64
ST38116	398	TC819BK	64
ST38122	398	TC8140NF	38
ST38306	398	TC8140P	39
ST38308	398	TCA01	81
ST38310	398	TCA02	81
ST38311	398	TCA05	75
ST38312	398	TCA06	406
ST38313	398	TCA07	406
ST38314	398	TCB80	136
ST38316	398	TCB80A	136
ST38317	398	TCB80C	136



Code No.	Page No.	Code No.	Page No.
TCB135	136	TCW806LN	72
TCB180	137	TCW806N	69
TC-BKEY	82	TCW806N1	69
TCC01	133, 137	TCW807N	70
TCC02	133, 137	TCW808N	70
TCC03	133, 137	TCW809N	72
TC-COVER	80	TCW810N	71
TC-COVER1	81	TCW810NBK	71
TCDIVL	76	TCW816LNSTACK	65
TCDIVS	76	TCW819STACK	65
TCDRK	82	TCW907X	69
TCDSH	80	TC-WC02	81
TCEMM249N	44	TCW-CAB	77
TCEMM417N	43	TCW-CAB01	77
TCEMM430B	45	TCW-CAB02	77
TCF01	76	TCW-CAB03	78
TCF02	76	TCW-CAB04	78
TC-FB01	131	TCW-D3	77
TC-FB02	131	TCW-HK02	83, 133
TC-FB03	131	TCW-HK10	83, 133
TC-H01	130	TCW-HK20	83, 133
TC-H02	130	TCW-HK45	83, 133
TC-H05	130	TCW-HK90	83, 133
TC-LBK	131	TCW-HKAIR	83, 133
TC-LEG	131	TCW-HKB	83, 133
TC-LOCK3	82	TCWPRK	82
TC-LOCK5	82	TCW-SP	83
TC-MAG	76, 402	TCW-SP01	83
TC-MAT	76	TCW-SW	80
TCMM277EV	38	TDD03050	369
TCMM479	28-29	TDD04070	369
TCMM491N	37	TDD05080	369
TCMM545N	36	TDD06100	369
TCMM546N	35	TDD08125	369
TCMM569EV	30-31	TDD10150	369
TCMM600	28-29	TDD12175	369
TCMM622N	32-33	TDT03050	369
TCMM715N	26-27	TDT04070	369
TCMM1001N	22-23	TDT05080	369
TCMM1001P	24-25	TDT06100	369
TCMM1055EV	20-21	TDT08125	369
TCMM1055N	18-19	TDT10150	369
TCMME09A	42	TDT12175	369
TCMME09B	47	TED441-T	126, 339
TCMME09C	46	TED909TXN	125, 305
TCMME11A	46	TED911N	124, 300
TCMMIND08	34	TED1227	116, 174
TCMONSTER	14-15	TED1489	116, 158
TCMONSTER02	16-17	TED3836	116, 165
TCNBC	79	TED6512R	120, 239
TCP445C	74	TED6512RS	120, 241
TC-PA01	131	TED6515	119, 231
TC-PA02	131	TED8012	119, 230
TC-PA03	131	TED9121	118, 212
TCPRK	82	TEDADJ4	123, 258
TCRFH	80	TEDHEX7	122, 272
TC-S01	132	TEDHT42	123, 266
TC-S02	132	TEDPC14	127, 409
TC-S03	134	TEDSD95	122, 214, 282, 318
TC-S03AL	132	TEDTX7	122, 277
TC-S03AR	132	TEDV440	126, 334
TC-S04	134	TEDV909N	125, 331
TCSB	73	TEX915N	124, 300
TCSB16	73	TEX1238	123, 283, 285
TC-SC	72	TEX2032	120, 231
TC-SL01	132	TEX3403	118, 178
TC-SL02	132	TEX3410	118, 178
TC-SL03AL	132	TEX6308	120, 246
TC-SL03AR	132	TEXEXT13	117, 186
TCSMC	78	TEXFLS06	120, 246
TCT01	133, 137	TEXMB02	127, 259, 339
TCT02	133, 137	TEXMDTN	125, 311
TCT03	133, 137	TEXMP12	123, 289
TCT04	133, 137	TEXPB4	128, 399
TC-TB01	80, 130	TEXTB05	116, 192, 379
TC-TB02	80, 130	TEXW05	128, 384
TC-TB03	80, 130	TF22	362
TCTMC	78	TF30	362
TC-UPRL	131	TF76	362
TC-UPRLS	131	TF76RK	362
TC-UPRR	131	TF300	364
TC-UPRRS	131	TF300RK	364
TCW207N	71	TF2230RK	362
TCW707EV	70	TFA10	363
TCW803N	68	TFA12	363
TCW804N	68	TFA15	363

Code No.	Page No.	Code No.	Page No.
TFA22	363	TT9116	94, 211
TFA0252RK	363	TT9120D	95, 211
TFP01	363	TT9207	94, 211
TFP01RK	363	TT9207A	94, 211
TFP02	363	TT9212TX	95, 212
TFP02RK	363	TTADJ04	100, 258
T-HD	192, 197, 262	TTADP17	93, 188
T-HD01	192, 197, 262, 379	TTAF32	89, 157, 164
TM028	315	TTALU	86
TM029	315	TTBE18	111, 398
TM035NF	48	TTBS35	89, 157, 165
TM079	51, 162	TTCM05D	114, 427
TM079E	51, 162	TTCP04	111, 395
TM095	52, 155, 170	TTCP121	110, 394
TM106	52, 154, 163, 170	TTD00	87
TM111	156, 163, 171	TTD01	87
TM127	52, 156, 164, 171	TTD02	87
TM149	378	TTD441	105, 338
TM708	306	TTD441-T	106, 338
TMSE05S	397	TTD912TXN	103, 305
TORP01E	280	TTD914N	102, 300
TORQ02	280	TTD9416	96, 213
TORQ03	280	TTDAWM13M	93, 423
TORQ04	280	TTDB28	111, 366
TORQ05	280	TTDCT05	108, 360
TORQ99E	280	TTDTD34	114, 367
TORQS01	280	TTDV910N	105, 331
TORQ	281	TTEAF62	121, 232
TPM01	134	TTEISK33	119, 213
TPM02	134	TTEISK73	119, 212
TPT01	134	TTEMB11	127, 339
TPX2501003	325	TTEMB17	127, 339
TPX2501503	325	TTEMD98N	126, 301
TPX2502003	325	TTEMD122N	125, 301
TPX2502503	325	TTEPS12	128, 389
TPX2502703	325	TTESK32	118, 178
TPX2503003	325	TTESK63	117, 174
TPX2504003	325	TTESK77	117, 158, 166, 175
TQAG	289	TTESK85	118, 159, 166, 175
TQS018	289	TTESK86	117, 158, 166
TQS042	289	TTESP31	121, 232
TQS055	289	TTESP37	121, 232
TQS065	289	TTEVG11	127, 352
TR070	140	TTEX17	124
TR135	140	TTEX23	124, 261, 273
TRC1012	378	TTEX32	121, 232
TRC1418	378	TTHC03	109, 377
TS1218	204	TTHEX7	100, 272
TS3816	204	TTHEX7AF	100, 274
TT00	86	TTHEX7S	100, 272
TT01	86	TTHEX16	91, 173
TT02	86	TTHEX23	91, 173
TT03	86	TTHP08	100, 262
TT04	86	TTHR81	112, 414
TT440	105, 338	TTHT28	101, 266
TT440-T	106, 338	TTID20	95, 214
TT474-5	106, 348	TTK40	108, 372
TT474-7	107, 348	TTMD12D	103, 302
TT474-7E	107, 348	TTMD74	103, 317
TT804	109, 392	TTMD74-1	326
TT917N	102, 299	TTMD74-2	326
TT917TXN	103, 305	TTMDRT64	104, 317
TT1205	90, 172	TTMI16	105, 307, 346
TT1211	90, 172, 190	TTNF12	108, 390
TT1215AF	91, 173	TTNF12-01	390
TT1217	90, 172	TTNF12-02	390
TT1217-6	90, 172	TTNF12-03	390
TT1218	91, 172	TTNF12-04	390
TT1218-6	91, 172	TTNF12-05	390
TT1236	97, 230	TTNF12-06	390
TT1435	88, 157	TTNF12-07	390
TT3592	97, 230	TTNF12-08	390
TT3816	89, 164	TTNF12-09	390
TT3819	88, 164	TTNF12-10	390
TT6010M	96, 243	TTNF12-11	390
TT6208	99, 248	TTNF12-12	390
TT6506	99, 252	TTNR81	112, 415
TT6508R	98, 239	TTOS16	109, 377, 380
TT6508RAF	98, 242	TTPC09	112, 408
TT6508RF	98, 243	TTPS09	113, 388
TT6508RS	98, 240	TTPS09E	113, 388
TT6511R	98, 239	TTPSAD	112, 385
TT6511RS	99, 241	TTPSPG	108, 352, 355
TT8012	96, 230	TTPSTQ04	102, 147, 286
TT9015HX	95, 212	TTRORS	99, 254
TT9024	94, 210	TTRS15	92, 174



Code No.	Page No.	Code No.	Page No.
TTSD39	101, 281	TX7001002	324
TTSN11	111, 397	TX7001502	324
TTSR04	109, 377	TX7002002	324
TTSS07	109, 387	TX7002502	324
TTTC06	114, 363	TXP3001001	217, 325
TTTD17	114, 367	TXP3001005	217, 325
TTTF10	110, 364	TXP3001501	217, 325
TTTM03	111, 376, 402	TXP3001505	217, 325
TTTM08	112, 376, 403	TXP3002001	217, 325
TTTS08	110, 213, 223, 385	TXP3002005	217, 325
TTTX18	92, 173	TXP3002501	217, 325
TTTX7	101, 277	TXP3002505	217, 325
TTTX23	92, 173	TXP3002701	217, 325
TTTX30	89, 157, 165	TXP3002705	217, 325
TTTXH15	92, 174	TXP3003001	217, 325
TTV440	106, 334	TXP3003005	217, 325
TTV706N	104, 330	TXP3004001	217, 325
TTV907N	105, 330	TXP3004005	217, 325
TTVG05	107, 352	TXP5001001	217, 325
TTX00	87	TXP5001501	217, 325
TTX01	87	TXP5002001	217, 325
TTX02	88	TXP5002501	217, 325
TTX03	88	TXP5002701	217, 325
TTX34AF	93, 179	TXP5003001	217, 325
TTX474-9	107, 349	TXP5004001	217, 325
TTX918N	104, 300	TXP8902001	217, 325
TTX1292	102, 285	TXP8902501	217, 325
TTX2032	97, 231	TXP8903001	217, 325
TTX2640	97, 231	TXX1015	302
TTX3404	92, 178	TXX2025	302
TTX3404S	93, 178	TXX3040	302
TTX3414	93, 178	TXX32101505	323
TTX3892	101, 260, 283	TXX32202505	323
TTX6311	99, 245	WCC06	408
TTX9415	96, 213	WCC08	408
TTXEXT13	92, 186	WCC10	408
TTXF05	108, 390	WCC12	408
TTXFLS06	99, 246	WCC14	408
TTXLMP12	97, 244	WCC16	408
TTXMB02	106, 338	WCC18	408
TTXMD41N	104, 317	WCC20	408
TTXMDN	101, 261	WCC22	408
TTXMDTN	104, 311	WCC25	408
TTXMP12	102, 289	WCC32	408
TTXPB3	110, 399	WCC38	408
TTXPB3A	110, 382, 400	WCS04L	408
TTXQRS07	100, 263	WCS04S	408
TTXTB05	89, 165, 192, 379	WR8012	146, 230
TTXTB09	90, 165, 196, 262	WRDF06	146, 253
TTZ01	88	WRFL05	149, 391
TTZVG03	107, 352	WRFLS05	147, 247
TV18N	330	WRHEX07	147, 272
TW1160	347	WRHEX07AF	147, 274
TW1180	347	WRMB04	148, 339
TW2125	347	WRMBV04	149, 334
TW2160	347	WRMD10N	148, 301
TW2180	347	WRMDT05N	148, 311
TWB-4VWD	136	WRMDV05N	148, 331
TWB-15TOP	135	WRMDV07N	148, 331
TWB-20TOP	135	WRPC10	149, 409
TWB1500	135	WRSP12	146, 231
TWB-1500A	135	WRSP12LMP	146, 244
TWB2000	135	WRSP12RS	146, 241
TWB-2000A	135	WRTX07	147, 277
TWB-FB	135	WRWC07	149, 408
TWB-LEG	135		
TWB-PA	135		
TWB-UPR	135		
TX2500603	323		
TX2500703	323		
TX2500803	323		
TX2500903	323		
TX2501003	323		
TX2501503	323		
TX2502003	323		
TX2502503	323		
TX2502703	323		
TX2503003	323		
TX2504003	323		
TX5000803	324		
TX5001003	324		
TX5001503	324		
TX5002003	324		
TX5002503	324		
TX5002703	324		
TX5003003	324		





www.tengtools.com



YouTube

